



## Board assignment heuristics for nail laminated out-of-grade timber

Joseph M. Gattas, Caitlin Reid, Tony Dakin, Jon Shanks & Robert L. McGavin

To cite this article: Joseph M. Gattas, Caitlin Reid, Tony Dakin, Jon Shanks & Robert L. McGavin (14 Oct 2024): Board assignment heuristics for nail laminated out-of-grade timber, Australian Journal of Civil Engineering, DOI: [10.1080/14488353.2024.2403049](https://doi.org/10.1080/14488353.2024.2403049)

To link to this article: <https://doi.org/10.1080/14488353.2024.2403049>



© 2024 The Author(s). Published by Informa UK Limited, trading as Taylor & Francis Group.



Published online: 14 Oct 2024.



Submit your article to this journal [↗](#)



Article views: 105



View related articles [↗](#)



View Crossmark data [↗](#)

# Board assignment heuristics for nail laminated out-of-grade timber

Joseph M. Gattas<sup>a</sup>, Caitlin Reid<sup>a</sup>, Tony Dakin<sup>b</sup>, Jon Shanks<sup>c</sup> and Robert L. McGavin<sup>d</sup>

<sup>a</sup>School of Civil Engineering, The University of Queensland, Brisbane, Queensland, Australia; <sup>b</sup>Hyne Timber, Maryborough, Queensland, Australia; <sup>c</sup>Centre for Sustainable Architecture with Wood, University of Tasmania, Launceston, Tasmania, Australia; <sup>d</sup>Queensland Government Department of Agriculture and Fisheries, Brisbane, Queensland, Australia

## ABSTRACT

Structural sawn timber, sourced from softwood plantations, is widely used in lightweight timber-framed residential housing and in engineered wood products for contemporary mass timber construction. However, a significant proportion of milled timber boards are considered 'out-of-grade', failing to attain a structural grade under existing classifications systems due to various stiffness, strength, and/or utility-limiting features. This study investigates the potential of controlled lamination techniques to produce structurally usable laminated timber products from out-of-grade timber, using a minimal number of requisite boards. Numerical and experimental methods were employed to compare different board assignment heuristics, in terms of reducing the stiffness variability in laminated board populations. The results indicate that controlled board locations produced remarkably consistent laminated products, achieving very low variability even with a minimum lamination of only two boards. The findings of this paper suggest that controlled lamination techniques have the potential to transform low-value out-of-grade timber into a valuable resource for value-added applications, challenging the existing market perception that out-of-grade timber lacks structural usability.

## ARTICLE HISTORY

Received 4 August 2024  
Accepted 4 September 2024

## KEYWORDS

Out-of-grade timber;  
laminated timber; controlled  
lamination system;  
engineered wood products

## 1. Introduction

### 1.1. Out-of-grade sawn timber



Structural sawn timber, sourced from softwood plantations, is a highly versatile and sustainable construction material. Widely used in lightweight timber-framed residential housing, it is also critical to the production of engineered wood products used in contemporary mass timber construction (Foliente 2000). Its renewability, carbon sequestration potential, and low embodied energy make it a highly attractive resource for sustainable building design (Thomas and Ding 2018). Its workability, versatility, and high strength-to-weight ratio make it an ideal resource for efficient and economical building construction (Balasbaneh and Marsono 2017; J. Li, Rismanchi, and Ngo 2019).

During the sawn timber production process, boards are assigned a structural grade based on their mechanical and visual characteristics. Machine-stress grading is the primary method used for grading structural softwood boards. This process evaluates board stiffness by measuring deformation and load resistance during flatwise bending, as well as physical characteristics based on testing standards defined in Australian/New Zealand Standard AS/NZS 1748.2, for stress-grading solid timber for structural purposes (AS/NZS 1748.2, 2011). Another method used is visual-stress

grading, which has lower stiffness requirements but imposes additional limitations on strength-limiting physical characteristics (AS 2858, 2008).

In Australia, Machine Graded Pine (MGP) grades are used for the majority of structural pine. There is significant and ongoing research effort in optimisation of sawmill operations to maximise the volume and grade, and thus value, of boards recovered from processed logs (Hosseini and Peer 2022). However, even after process optimisation, a significant proportion of timber boards produced by Australian softwood plantations fail to attain a minimum classification of MGP10. From prior studies, for slash and southern pine resources, only 11–55% of processed boards meet an MGP grade, depending on sawlog quality (Bailleres et al. 2019; Harding 2009).

Out-of-grade timber boards can exhibit a wide variety of stiffness, strength, and utility-limiting features that correspond to the range of physical and mechanical characteristics considered by grading rules (Cherry et al. 2019). These features include material inhomogeneities, such as knots, splits, resin pockets, and grain angle, which can reduce a board's strength and stiffness (Buksnowitz et al. 2010; Cherry, Karunasena, and Manalo 2022; Lerm et al. 2017; Nicoletta et al. 2017). Geometric irregularities such as wane, cup, twist, bow, and spring distortions can also affect a board's practical use and structural

**CONTACT** Joseph M. Gattas  j.gattas@uq.edu.au  School of Civil Engineering, The University of Queensland, Brisbane, Queensland 4072, Australia

© 2024 The Author(s). Published by Informa UK Limited, trading as Taylor & Francis Group.

This is an Open Access article distributed under the terms of the Creative Commons Attribution-NonCommercial-NoDerivatives License (<http://creativecommons.org/licenses/by-nc-nd/4.0/>), which permits non-commercial re-use, distribution, and reproduction in any medium, provided the original work is properly cited, and is not altered, transformed, or built upon in any way. The terms on which this article has been published allow the posting of the Accepted Manuscript in a repository by the author(s) or with their consent.

function (Johansson and Kliger 2002; Martitegui et al. 2007; Vestøl and Høibø 2010). Due to the range and variability of these features, the perceived structural usability and market value of out-of-grade timber is significantly reduced.

### 1.2. Mass lamination of alternative timber feedstocks

Engineered wood products, such as laminated timber products, have been shown to effectively reduce the influence of natural inhomogeneities and localised defects present in most timber materials (Gilbert et al. 2017). Laminated timber exhibits load sharing between connected lamellas, with load path redistribution around lower-performing material regions and into higher-stiffness material regions when loaded. As a result, laminated timber materials exhibit reduced variability in strength and stiffness compared to solid timber of the same dimension, which translates to higher characteristic strength values and less severe design capacity reduction factors (Falk and Colling 1995).

Timber materials classified as low-grade and used for industrial markets often possess mechanical properties exceeding minimum requirements for their application to value-added laminated products (da Rosa Azambuja et al. 2023; da Rosa Azambuja, DeVallance, and McNeel 2022). Thus, mass lamination has been explored for the reconstitution of higher-value timber products from under-utilised or secondary timber feedstocks. Due to the high capital and operational costs that are required to support glue lamination, studies often consider mechanical lamination techniques, such as nail-lamination (NLT), bolt-lamination, or integral joints. Materials investigated for mechanical lamination include recycled materials such as deconstructed decking lumber (Janowiak et al. 2014) and salvaged construction waste (Fink, Ruan, and Filz 2019), and low-value log resources such as small-diameter logs (Herberg 2018), beetle-killed pine (Wilson 2012) and fast-growth eucalypt hardwoods (Derikvand, Jiao, et al. 2019).

The structural behaviours of mass laminated timber can be predicted and enhanced by controlling the location of individual timber boards within a manufactured cross-section (Kandler et al. 2015; Rose et al. 2018). When the properties of the constituent boards are known, as is the case with structurally-graded timber in a grading process qualified to AS/NZS 1748.2–2011 (2011), this is well understood. For example, glue-laminated beams and cross-laminated panels can achieve high resource and structural efficiency by using lower-grade timber for internal lamellas and higher-grade timber for external lamellas (Lee et al. 2005; X. Li et al. 2020). However, for out-of-grade timber, there is much less understanding about

how best to achieve a homogenous, structurally usable product. Studies have shown mixed results, with some reporting the successful use of non-structural pine boards as internal layers of CLT panels (Sigrist and Lehmann 2014), while others were unable to achieve satisfactory structural performance (Alencar and de Melo Moura 2019). In one study, a controlled lamination system that combined high- and low-stiffness *Eucalyptus nitens* boards in a set of 9 NLT floor panels achieved an extremely low variability in the manufactured population stiffness performance (Derikvand, Kotlarewski, et al. 2019).

### 1.3. Aim

Existing research into lamination of underutilised timber feedstocks has primarily focused on creation of mass laminated products. Out-of-grade pine timber is generated as a by-product of structural board production for lightweight framing in residential markets. As such, it has a distinct problem when considered as such a potential feedstock in that it is produced in a far higher volume than would be required for existing markets for mass laminated timber products. In contrast, a minimally laminated product, made with as few as two boards only, would remain feasible for economic application in typical lightweight framing uses.

The research contribution of this paper is thus to explore how controlled lamination techniques can produce consistent and structurally usable laminated timber products from a minimal number of out-of-grade boards. Numerical and experimental methods will be used to investigate practical approaches to mitigate the negative impact of localised defects and population variability using two and four-board laminations of out-of-grade timber. Results of this study will provide valuable insights into the potential for using this low-value timber resource in value-added applications.

## 2. Materials and methods

### 2.1. Board inventory database

A pack of 220 non-structural timber boards was provided by industry partner Hyne Timber, containing a representative range of defects and features contributing to their out-of-grade classification. Digital information collected during board production was also provided, including: a unique Board ID; average and rolling stiffness measurement data; four-sided image capture; and defect locations and types. Such information is typical to that captured in a mill producing stress graded timber to AS/NZS 1748–2011 (2011). Board data was stored in different formats and locations depending on its generating source.

For example, board production data was stored in a structured XML file, stiffness data in a CSV file, and image data in a nested folder hierarchy. A MATLAB toolbox was written to import and store data within a unified data structure; the imported set of board data is termed the *board inventory database*. The original board data (279Mb size on disk) was imported in 27 seconds using an Intel i7-4790 PC with 16Gb RAM, with the generated database stored as a MATLAB variable with 198Mb size in memory.

The average and rolling stiffness measurement data form the basis of the lamination studies conducted in this paper and so are explained in further detail. A single example board, inventory ID 1 and production ID 38190626, are shown in Figure 1(a) using top, bottom, left, and right side board images. The board is 90 mm wide, 35 mm thick, and 4800 mm long. During production, the board travels through a Metriguard 7200 High Capacity Lumber Tester (HCLT) which deflects the board both downwards and upwards by a fixed distance and over a 4-ft (1219 mm) span, Figure 1(b). There is assumed to be no contraflexure at the supports, as the HCLT rollers are inclined to the angle that a simply supported beam with uniform stiffness would meet over the given span. The force at the two mid-span deflections is stored and converted to a single local flatwise bending stiffness  $E$  measurement, with the double-bend compensating for deviations in the straightness of the board. Board  $E$  is collected at 1-in

(25.4 mm) increments to give a continuous rolling stiffness measurement, starting and stopping approximately 29-in (740 mm) from board ends, Figure 1(c). The average of all rolling stiffness measurements gives the board flatwise bending stiffness  $E_{avg}$ . The lowest recorded rolling stiffness measurement gives the minimum board stiffness  $E_{min}$ . The HCLT geometry means that the apparent reduction in  $E$  at a low point can be amplified; as such,  $E_{min}$  is not typically used in grading as a measure of stiffness, instead it is used as a proxy for strength, in conjunction with visual grading characteristics.

Stiffness data for all boards is plotted in Figure 2(a) as  $E_{avg}$  versus  $E_{min}/E_{avg}$ . Following nomenclature in Australia/New Zealand Standard AS/NZS 4063.2 for structural timber characterisation (AS4063.2 2010), population sample size  $n$ , mean modulus of elasticity  $\bar{E}$ , standard deviation  $S$ , and fifth percentile modulus of elasticity  $E_{05}$  are summarised in Table 1, calculated with statistical functions in MATLAB. The coefficient of variation (CoV) for board stiffnesses is 36%, within the expected range for sawn timber boards of 35–45% (AS/NZS 4063.2 2010).

Many boards meet the stiffness threshold for MGP timber grades, however are classified as out-of-grade due to excessive wane or distortion. Many boards also have significant localised stiffness reductions, with  $E_{min}/E_{avg}$  as low as 13.7%. As would be expected, these often occur in locations where the stiffness

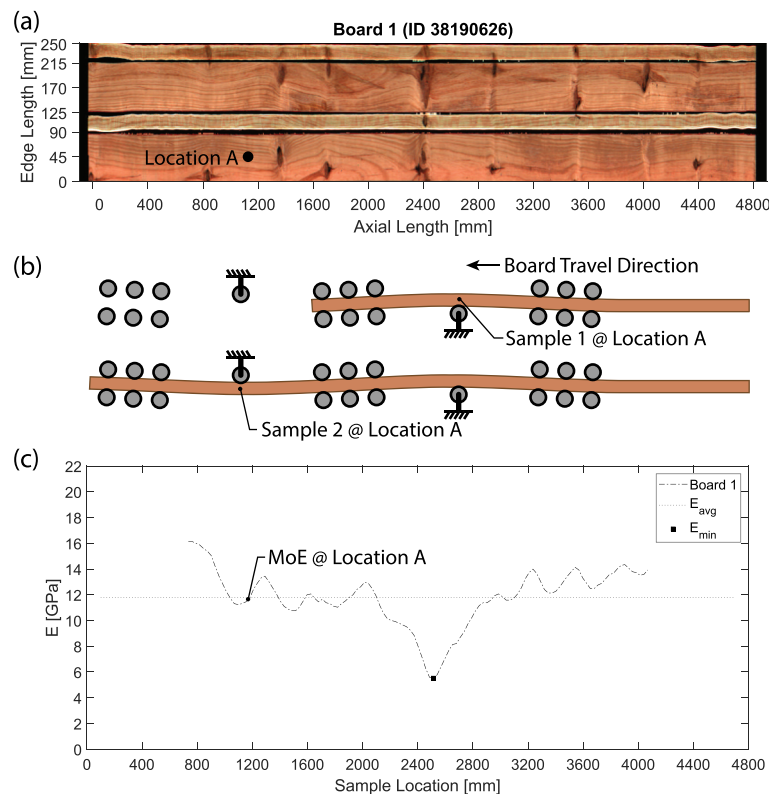

**Figure 1.** Provided data for an individual board. (a) Four-sided image capture of board 1. (b) HCLT rolling stiffness sample collection. (c) Rolling, average, and minimum stiffness data for board 1. Location a in (b) shows the upwards and downwards deflection point, used to evaluate the local flatwise bending stiffness at the corresponding location in (c).

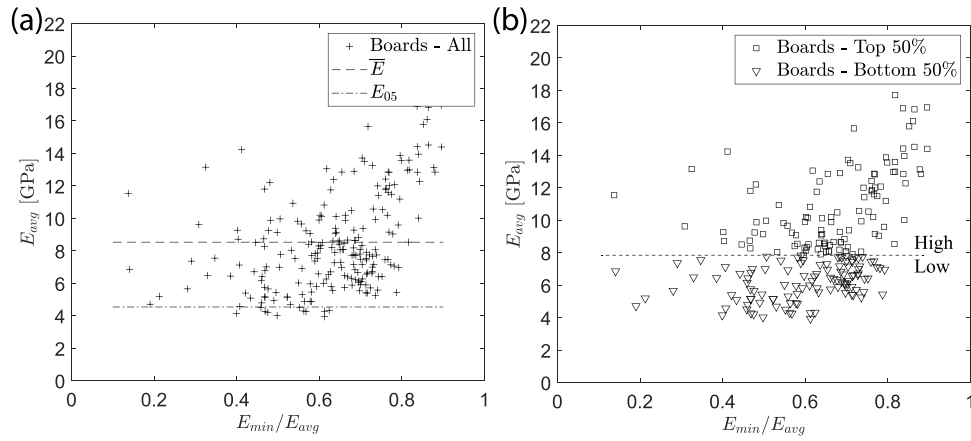

**Figure 2.** Average and minimum stiffness data in board inventory database. (a) All boards and (b) high/low stiffness groupings.

**Table 1.** Stiffness data for individual board populations. † indicates design characteristic value for MoE is governed by  $E_{05}$ .

Group	Count $n$	Range $E_{avg}$ MPa	$\bar{E}$ MPa	$S$ (CoV) MPa (%)	$E_{05}$ MPa	$E_k$ MPa
All Boards	220	3940 – 18,710	8530	3080 (36%)	4540	6490 <sup>†</sup>
<i>High/Low Heuristic</i>						
Low	110	3940 – 7830	6160	1080 (18%)	4270	6100 <sup>†</sup>
High	110	7870 – 18,710	10910	2560 (23%)	8060	10,910

sampling region (1219 mm length) contains a large number of stiffness-reducing defects such as knots and grain slope, as can be seen in Figure 1(a) for the minimum stiffness location in Figure 1(c). This low-stiffness skew has a detrimental impact on determining characteristic values from test data. From AS/NZS 4063.2, the MoE characteristic value  $E_k$  is taken as the lesser of mean  $\bar{E}$  and factored 5th percentile  $E_{05}/0.7$  MoE values, adjusted for statistical sample factors.

## 2.2. Board assignment heuristics

This paper explores how variability in nail-laminated timber boards can be minimised through the controlled specification of board locations. As such, the digital inventory of timber boards was used to test three *board assignment heuristics*, developed to simulate differing levels of board location control

within a production environment. The first heuristic is developed to optimise the board location assignments to give the lowest possible variability in the laminated product. It achieves this by progressively combining boards with the highest and lowest  $E_{avg}$ , Figure 3(a), thus requiring a complete prior knowledge of board properties. The second heuristic combines boards into a laminated product based on their production order, Figure 3(b). This is assumed as equivalent to randomly nailing the boards together, requiring no prior knowledge of board properties or location control.

The first and second heuristics serve as the limit cases, of complete control and no control over board locations, respectively. However, the handling requirement for fabrication of boards generated using the first heuristic is unrealistic in an automated production environment, as each board would need to be sorted

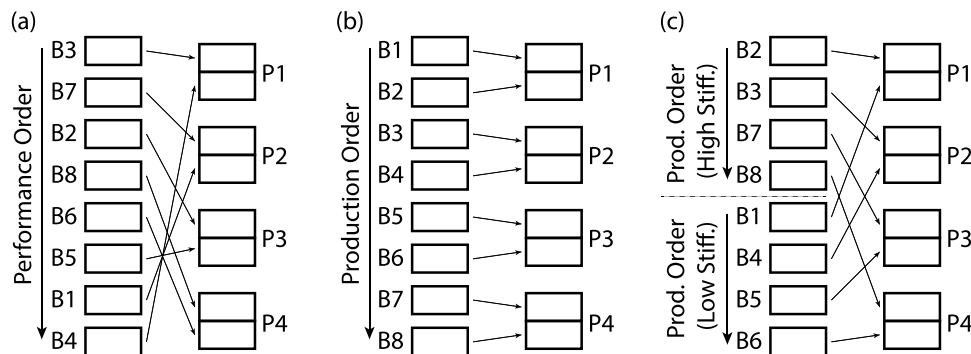

**Figure 3.** Board assignment heuristics. (a) Optimised assignment based on performance order. (b) Random assignment based on production order. (c) High/low assignment based on production order within two presorted stiffness groups.



and stored in order of highest-to-lowest stiffness, or into a different storage area for each laminated product. A third heuristic was thus developed as an intermediate case, based on a presorting of boards into two high or low stiffness groups. Subsequent lamination uses one board from each grouping, randomised based on production order, Figure 3(c). This heuristic requires prior historical knowledge of typical properties for a similar board population, to establish cut-off values that give an equal number of boards in each stiffness group. The handling effort is significantly reduced as compared to the first heuristic, as boards need only be presorted into two storage areas for the high and low groups, similar to how boards are typically sorted into separate grades.

Stiffness data for the high and low groups used for heuristic three are shown in Figure 1(b) and Table 1, using a cut-off value of 7850 MPa. Note that while both groups contain the same number of boards, there is a higher CoV and range for the high stiffness group. This arises from the presence of boards with very high bending stiffness classified as out-of-grade due to visual defects, typically wane. These occur in a relatively lower proportion as compared to boards classified as out-of-grade due to low stiffness or strength and stiffness-reducing defects such as knots.

### 2.3. Simulated lamination with board assignment heuristics

The three heuristics were applied to generate board location indexes for 110 pair laminations, comprising 2 boards each. Pair laminations were investigated as both the minimum possible number of laminated boards and as a very common use-case in residential framing. On the latter, nail lamination of two to four boards for creating larger-dimension timber sections is allowed for in Australian Standard AS 1684 (Residential timber-framed construction) (2010). Specific clauses describing use and required nail patterns for vertical lamination of beams, lamination of wall studs, and horizontal lamination of wall plates are described in Clauses 2.3–2.5, respectively. Span tables in AS1684 Supplements are also formulated to cover up to 4 board laminations, depending on structural element type (Jiang, Ottenhaus, and Gattas 2023).

The three developed heuristics were designated as ‘optimised’, ‘randomised’, and ‘high/low’ pair laminations, for heuristics one to three, respectively. The rolling flatwise bending stiffness of pair laminations was numerically evaluated by combining the rolling stiffness data of constituent boards with a 50% fibre volume fraction:

$$E = \frac{E^i + E^j}{2} \quad (1)$$

where  $i$  and  $j$  superscripts denote the constituent board IDs. Average and minimum stiffness values are calculated from the laminated rolling stiffness, Figure 4.

Pairs were additionally combined into 55 quad laminations. Optimised pair laminations were combined through re-application of heuristic one. Randomised and high/low pair laminations were combined based on production order. Rolling flatwise bending stiffness for quad laminations was evaluated with a 25% fibre volume fraction:

$$E = \frac{E^i + E^j + E^k + E^l}{4} \quad (2)$$

where  $i, j, k,$  and  $l$  superscripts denote the constituent board IDs. Average and minimum stiffness values are calculated from the laminated rolling stiffness, shown in Figure 4(a),(b) for an example pair and quad lamination, respectively.

For randomised and high/low laminations, board assignments will vary based on production order. Thus, a Monte Carlo simulation was used to randomly change the board production order and evaluate the distribution of laminated stiffness values in the simulation sample set. From a convergence study, 500 simulation runs were found as sufficient to give a variance between simulation runs of below 1%.

### 2.4. Specimen manufacture and experimental testing

Experimental testing was conducted to obtain acoustic and static stiffness measurements for individual boards and static stiffness measurements for pair and quad laminations. Individual board measurements are used to verify board inventory database information. Pair and quad lamination measurements are used to verify the heuristic application and numerical evaluation of laminated stiffnesses.

For individual board testing, 32 boards were selected as a random subset of the 220 board pack. Full length boards were first tested using the Beam Identification by Non-destructive Grading (BING) acoustic resonance method. BING tests obtain the acoustic modulus of elasticity (Acoustic MoE), based on frequency and density measurement, with further details available in (Baillères, Hopewell, and Boughton 2009). Boards were then cut to a partial 2880 mm length and tested under static four-point bending, to obtain the apparent modulus of elasticity in bending (Apparent MoE). Static tests were conducted according to standard industry practice, with four-point bending over a span of approximately  $30d$ . Boards were tested edgewise to match their laminated orientation, for a  $30 \times 90 = 2700$  mm test span plus 90 mm overhang at either end, for total board length of 2880 mm. Load application was at one-third and two-thirds of span length, giving a central mid-

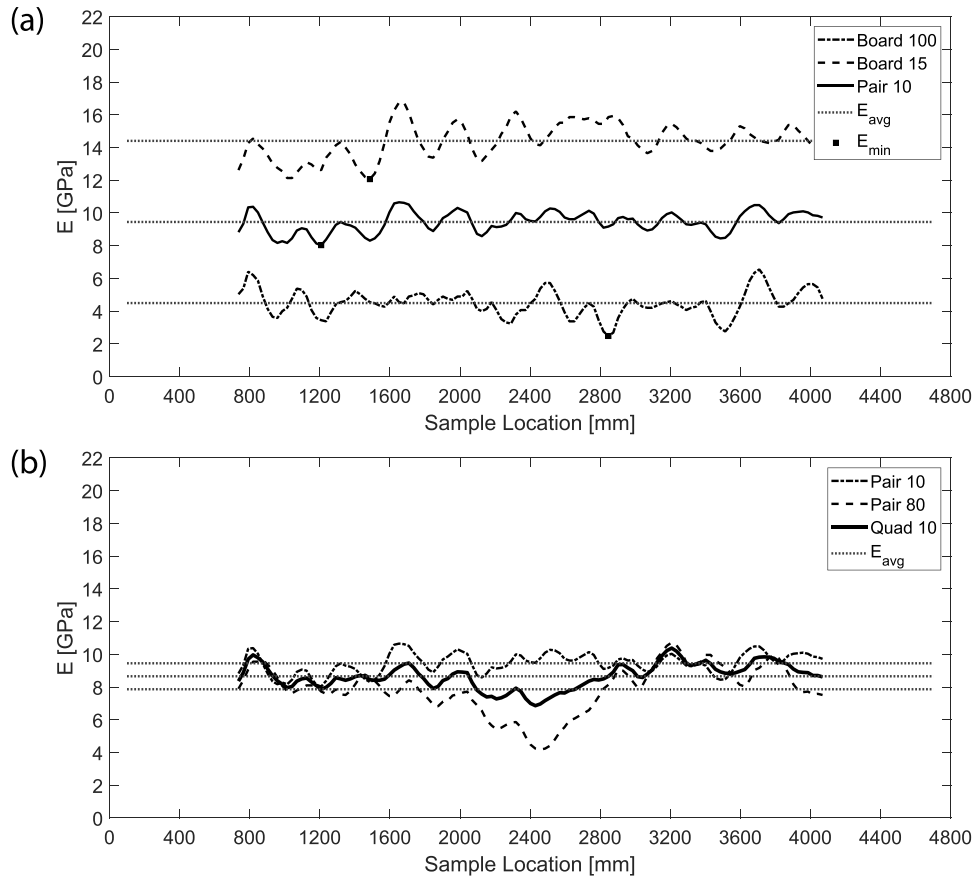

Figure 4. Evaluation of (a) pair and (b) quad lamination stiffness properties from constituent board data.

region of 900 mm between load points. Using the rolling stiffness data, the partial board length was selected at a location with the highest average stiffness over the central 900 mm region,  $E_{avg,900}$  in Figure 5(a).

For laminated board testing, board IDs for 16 pair and 8 quad laminations were generated as optimised laminations (heuristic one). Board assignments used the average stiffness of the 2880 mm board length,  $E_{avg,2880}$  in Figure 5(b). Laminations were formed by clamping boards together at middle and end locations, with prior research showing mechanical clamping gives similar stiffness values to nail-jointed pine board laminations (Taoum et al. 2019).

### 3. Results and discussion

#### 3.1. Verification of board inventory database and simulated laminations

A comparison of the inventory (continuous flatwise bending stiffness  $E_{avg}$ ) and experimental (Acoustic and Static MoE) stiffness values for individual boards are shown in Figure 6(a),(b) and summarised in Table 2. For 2880 mm boards, Acoustic MoE values are within 1% of inventory  $E_{avg}$  values and approximately 8% higher than Static MoE values. The over-prediction of continuous flatwise bending stiffness and acoustic MoE measurements, relative to static apparent

MoE measurements, is a known occurrence, and the observed results are consistent with 10–20% over-prediction ranges reported previously for Southern Pine (Bailleres et al. 2019; Yang et al. 2015). For full-length boards, Acoustic MoE values are approximately 10% higher than inventory  $E_{avg}$  values. As mentioned in Section 2.1, HCLT can exaggerate MoE lows that impact  $E_{avg}$  measurement, which may cause this slight difference. It can be concluded that the board inventory database is correctly importing and storing stiffness data, and that the data itself is accurate.

A comparison of the simulated and experimental stiffness values for pair and quad laminations are shown in Figure 7(c),(d) and summarised in Table 2. There is a good correspondence between simulated values for stiffness and variance and those measured experimentally. The experimental coefficient of variation is slightly higher than numerical prediction, which is expected due to the additional sources of variability inherent to physical testing. The relative over-prediction of simulated (continuous flatwise bending) and experimental (apparent MoE) stiffness reduces to 4% and 2% for pair and quad laminations, respectively. It can be concluded that numerical stiffness predictions for pair and quad laminations are sufficiently accurate for the relative evaluation of the developed board assignment heuristics, see next section.

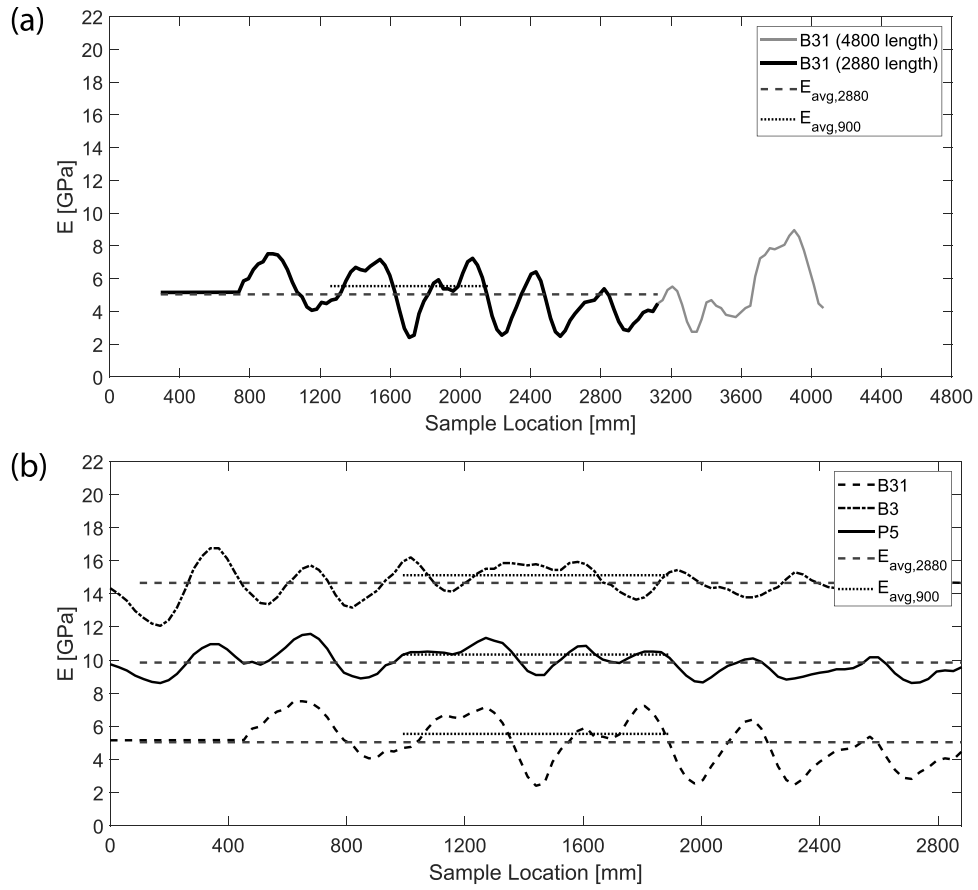

Figure 5. a) Selection of 2880mm region from 4800mm board length based on maximum  $E_{avg,900}$ . b) Example pair lamination from 2880mm boards.

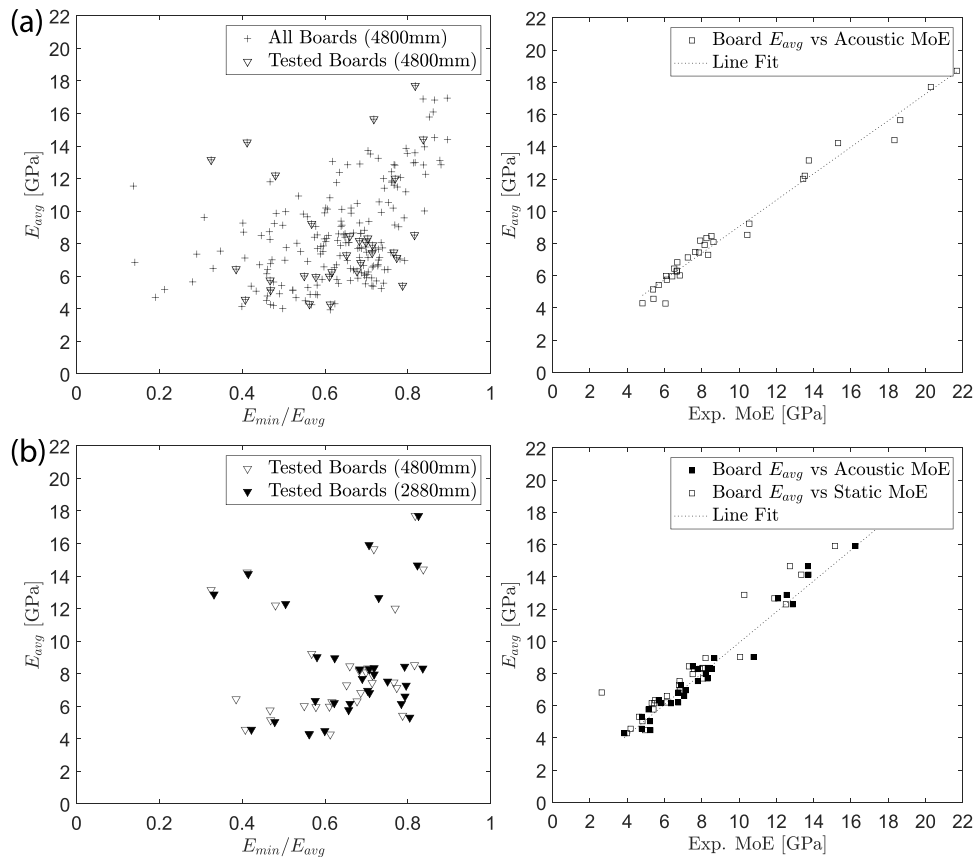

Figure 6. Board inventory data (left) and comparison with experimental results (right) for (a) 4800mm and (b) 2880mm long boards.



**Table 2.** Comparison of stiffness data obtained from board inventory database, simulated laminations and experimental testing. Note: 32 boards used for testing were selected as a random subset from the 220 boards in the inventory database.

Group	Count $n$	Range MPa	$\bar{E}$ MPa	$S$ (CoV) MPa (%)
<b>4800mm Boards</b>				
Inventory $E_{avg}$	32	4280 – 18,710	8730	3920 (45%)
Acoustic MoE	32	4820 – 21,680	9620	4710 (49%)
<b>2880mm Boards</b>				
Inventory $E_{avg}$	32	4300 – 18,960	8880	3920 (44%)
Acoustic MoE	32	3840 – 19,610	8920	4050 (45%)
Static MoE	32	2630 – 18,470	8240	3880 (47%)
<b>Optimised Pair Laminations</b>				
Numerical $E_{avg}$	16	7250 – 11,630	8880	1380 (16%)
Static MoE	16	5780 – 11,340	8570	1530 (18%)
<b>Optimised Quad Laminations</b>				
Numerical $E_{avg}$	8	8470 – 9550	8880	370 (4%)
Static MoE	8	7460 – 9740	8730	790 (9%)

### 3.2. Lamination with board assignment heuristics

A comparison of simulated stiffness values for optimised, randomised, and high/low laminations is shown in Figure 8. For randomised and high/low laminations, data is plotted from the board assignment of a single iteration with similar mean and standard deviation to the Monte Carlo simulation sample set; a comparison of laminated board stiffness variation across iterations is plotted in Appendix A1. For optimised laminations, data is

plotted from their single possible board assignment. Stiffness values are summarised in Table 3.

The first board assignment heuristic, with perfect control of board location within all laminations, is seen to succeed in achieving a rapid reduction in laminated population variance. The coefficient of variation for optimised pair and quad laminations of 9% and 4% is extremely low. This result is consistent with the low variability of 2.6% reported for the fully controlled 8-board lamination of *Eucalyptus nitens* in (Derikvand, Kotlarewski, et al. 2019).

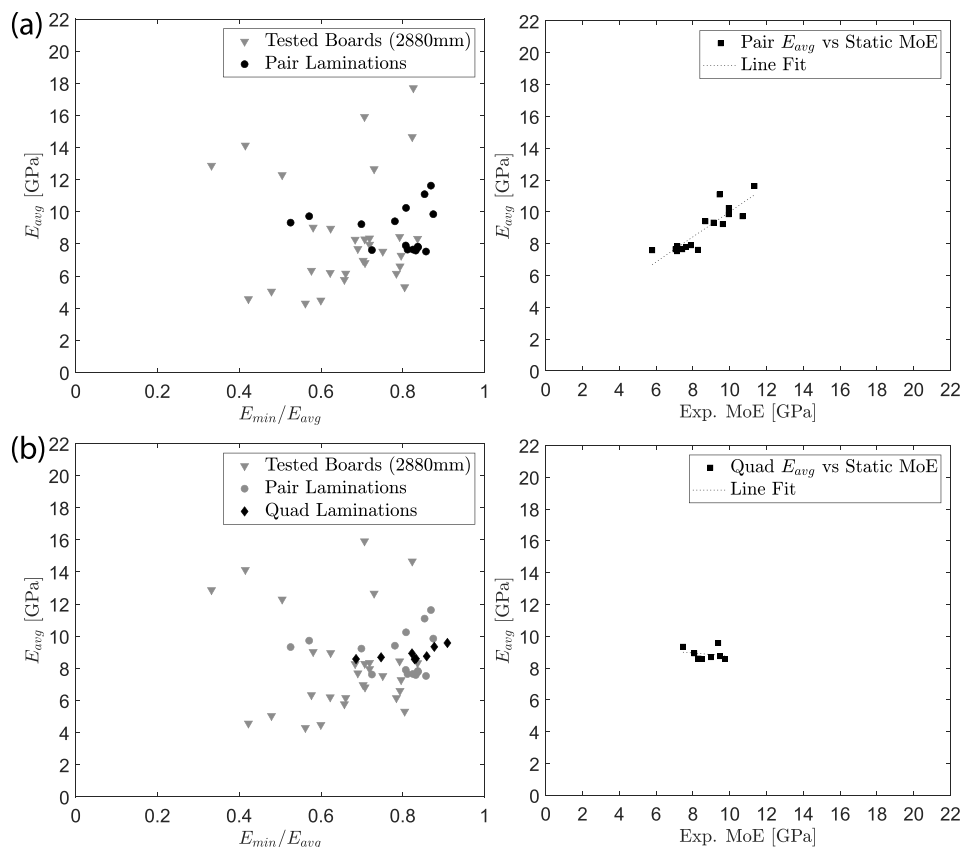

**Figure 7.** Simulated lamination data (left) and comparison with experimental results (right) for optimised (a) pair and (b) quad laminations.

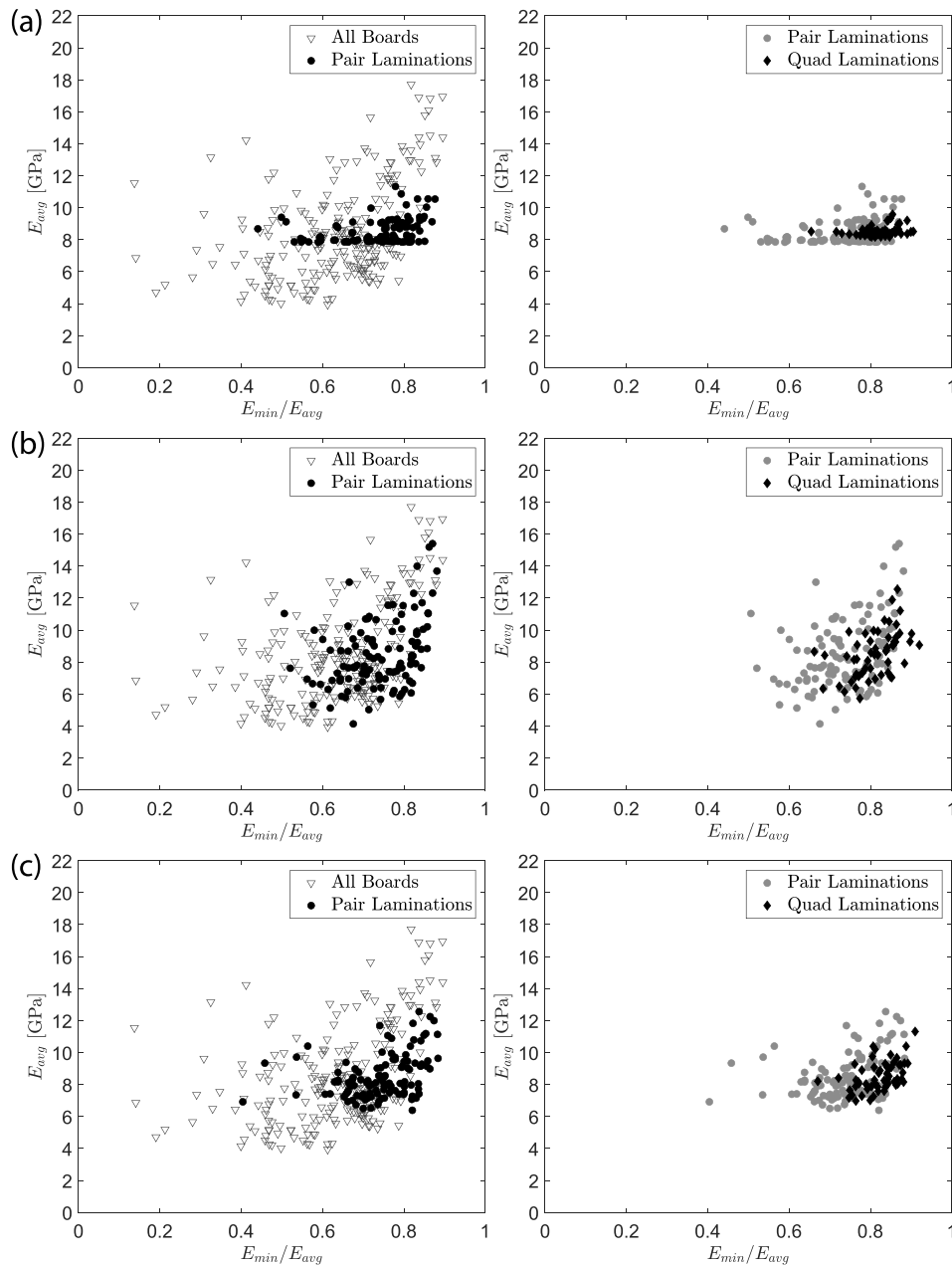

**Figure 8.** Pair (left) and quad (right) lamination population stiffness data. (a) Optimised, (b) random, (c) high/low. For (b)-(c), data is plotted from a single iteration with similar mean and standard deviation to simulation sample.

In the second board assignment heuristic, the randomised pair and quad laminations showed a much higher CoV of 25% and 17%, respectively. Quad lamination variation is consistent with a typical CoV range of 20–30% for glue-laminated

timber Apparent MoEs, obtained from random position testing as per AS/NZS4063.1 (2010). The reduction in CoV from the board population to the randomised pair and quad laminations is 29% and 52%, respectively. The latter is consistent with the

**Table 3.** Comparison of stiffness data for pair and quad laminations using optimised, randomised, and high/low board assignment heuristics. † indicates design characteristic value for MoE is governed by  $E_{05}$ .

Group	Count $n$	Range MPa	$\bar{E}$ MPa	$S$ (CoV) MPa (%)	$E_{05}$ MPa	$E_k$ MPa
<i>Pair Laminations</i>						
Optimised	110	7840 – 11,330	8530	760 (9%)	7850	8530
Randomised	110	3980 – 18,210	8530	2170 (25%)	5490	7840†
High/low	110	5900 – 13,270	8530	1380 (16%)	6640	8530
<i>Quad Laminations</i>						
Optimised	55	8180 – 9580	8530	310 (4%)	8180	8530
Randomised	55	4990 – 15,500	8530	1470 (17%)	6410	8530
High/low	55	6360 – 12,450	8530	920 (11%)	7170	8530

46–55% reduction reported for 4-board glue lamination from a low-grade timber board population in (Kandler et al. 2015).

For the third board assignment heuristic, high/low pair and quad laminations achieve a much lower CoV than randomised laminations, of 16% and 11%, respectively. The reduction in CoV from the board population to high/low pair and quad laminations is 55% and 70%, respectively. Of note is that the high/low heuristic achieved the same reduction in variance with two boards, as randomised assignment in this and prior studies achieved with four boards.

### 3.3. Discussion

The results above provide several key insights into the potential of lamination techniques to produce consistent and structurally sound laminated timber products from timber that would otherwise be considered as out-of-grade.

First, the optimised and high/low assignment heuristics demonstrate remarkable consistency in their results, achieving very low variability even with a minimum lamination of only two boards. In these pair laminations, the CoV is significantly reduced and  $E_{05}$  is raised to the extent that the population mean MoE  $\bar{E}$  governs  $E_k$ , Figure 9(a). Therefore, both optimised and high/low pair laminations have the same design characteristic stiffness  $E_k$ . However, the optimised heuristic requires considerably higher handling effort, making the high/low assignment heuristic a more efficient option to achieve the same level of stiffness.

Second, the randomised assignment heuristic results in relatively higher variability, which is insufficient to fully mitigate the negative impact of the boards with very low stiffness. This means that  $E_k$  is still governed by  $E_{05}$ , resulting in an 8% lower  $E_k$  for randomised pair lamination than for other pair lamination types.

Although variability in the randomised quad lamination is sufficiently reduced to prevent this, Figure 9(b), it is still higher than the exhibited variability in the high/low pair laminations. Thus, the high/low assignment heuristic is a more efficient option to achieve the same level of stiffness using fewer boards. It potentially also provides the opportunity to set limits for high and low groups, to achieve a target final laminated stiffness.

Third, regarding the structural usability of the laminated boards, the attained  $E_k = 8530$  MPa is below the required average MoE for MGP10 of 10,000 MPa, as expected for using out-grade timber. However, it is comfortably above the minimum stiffness requirement for visual stress grading, which is 6,900 MPa for an F5 grade. It is also above the minimum stiffness requirement for glue-laminated timber grades as permitted by AS1720.1, which is 8,000 MPa for a GL8 grade (AS1720.1 2010).

As noted previously, visual stress grades have additional limitations on strength-limiting physical characteristics, with the minimum F5 grade almost always strength- rather than stiffness-limited. Consideration of mechanical strength properties in out-of-grade laminated timber is out-of-scope for the present study and should be studied in future research using the presented board assignments heuristics. Expanding the study to include lowest local bending stiffness  $E_{min}$  and  $E_{min}$  location in the lamination heuristic as a threshold parameter may also help in attaining a structural grade, as it is highly correlated to strength prediction in Australian pine (Baillères et al. 2012; Baillères, Hopewell, and Boughton 2009). Characteristic strength values are also based on material strength at the fifth percentile level, so achieving an efficient reduction in CoV using a controlled lamination heuristic may facilitate minimum strength attainment. Lamination may also assist to reduce the severity of geometric defects which could otherwise prevent attainment of a structural grade.

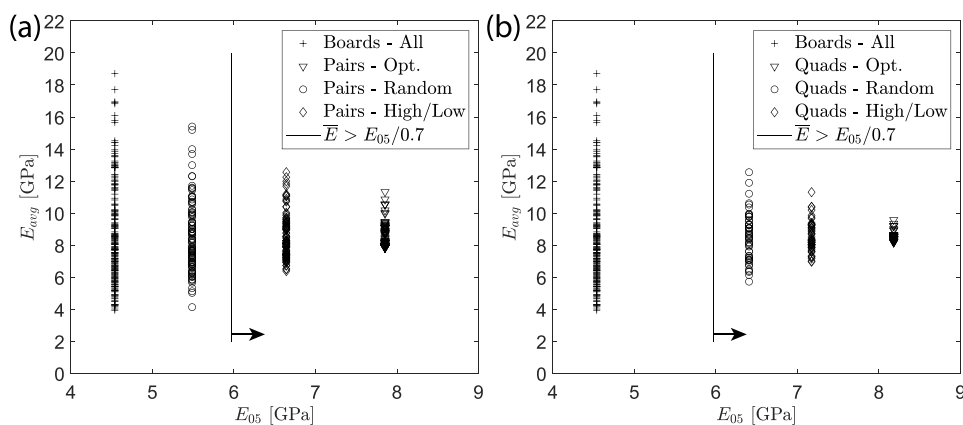

Figure 9. Population variability versus fifth percentile stiffness value for board assignment heuristics. (a) Pair and (b) quad laminations.

#### 4. Conclusions

In conclusion, this study has explored the use of controlled lamination techniques for producing reliable and structurally usable laminated timber products from out-of-grade timber. The study utilised both numerical and experimental methods to investigate practical approaches for mitigating the negative impact of localised defects and population variability while using a minimal number of laminated out-of-grade boards.

Three board assignment heuristics were developed to simulate differing levels of board location control within two and four-board laminated timber products. The first heuristic optimised the board locations to give the lowest possible variability in a set of laminated products. The second heuristic combined boards into a laminated product based on their pseudo-random production order. The third heuristic presorted boards into two groups based on high or low stiffness, which were then combined when laminated in their production order. The following conclusions were drawn from the obtained results:

- Laminated products made with controlled board locations demonstrated remarkable consistency in their results, achieving very low variability even with a minimum lamination of only two boards from the sample population studied.
- A relatively simple 'high/low' board assignment heuristic, based on lamination between two presorted stiffness groups, provided the same characteristic stiffness as an optimised board assignment heuristic.
- Randomised board assignment required more boards per lamination to achieve the same characteristic stiffness.

The attained stiffness values were too low for MGP10, but sufficient for other grades such as F5, GL8, or proprietary grades, indicating the potential for using out-of-grade timber in value-added applications. Future research can explore the potential of using these controlled lamination techniques for improving the mechanical strength properties of out-of-grade laminated timber.

#### Acknowledgments

This project was funded by the Australian Research Council ARC Future Timber Hub 'Industrial Transformation Hub to Transform Tall Timber Buildings' (IH150100030). The authors would like to thank Hyne Timber for supply of material and data use in this research and Dr Henri Baillères for information provided regarding stiffness measurement techniques.

#### Disclosure statement

The above research grant was funded in part with contributions from Hyne Timber. T. Dakin is an employee by Hyne Timber at time of submission, however completed testing for this study while previously employed by the Queensland Government Department of Agriculture and Fisheries. The remaining authors have no conflicts of interest to declare.

#### Funding

The work was supported by the Australian Research Council Research Hub to Transform Future Tall Timber Buildings [IH150100030].

#### ORCID

Joseph M. Gattas  <http://orcid.org/0000-0002-0878-583X>

#### Data availability statement

The data sets generated by the current study are available from the corresponding author on reasonable request.

#### References

- Alencar, J. B. M., and J. D. de Melo Moura. 2019. "Mechanical Behavior of Cross-Laminated Timber Panels Made of Low-Added-Value Timber." *Forest Products Journal* 69 (3): 177–184. <https://doi.org/10.13073/FPJ-D-18-00037>.
- AS1720.1-2010: *Timber structures, Part 1: Design methods*. 2010. Standard, Standards Australia.
- AS 2858-2008: *Timber - Softwood - Visually stress-graded for structural purposes*. 2008. Standard, Standards Australia.
- AS/NZS 1748.2: *Timber - Solid - Stress-graded for structural purposes*. 2011. Standard, Standards Australia.
- AS/NZS 4063.2:2010. 2010. *Characterization of Structural Timber - Determination of Characteristic Values, Standard, Standards Australia*.
- Baillères, H., G. Hopewell, and G. Boughton. 2009. MOE and MOR Assessment Technologies for Improving Graded Recovery of Exotic Pines in Australia. PNB040-0708. Victoria, Australia: Forest and Wood Products Australia.
- Baillères, H., G. Hopewell, G. Boughton, and L. Brancheriau. 2012. "Strength and Stiffness Assessment Technologies for Improving Grading Effectiveness of Radiata Pine Wood." *Bio Resources* 7 (1): 1264–1282. <https://doi.org/10.15376/biores.7.1.1264-1282>.
- Baillères, H., D. J. Lee, C. Kumar, S. Psaltis, G. Hopewell, and L. Brancheriau. 2019. URL: Improving Returns from Southern Pine Plantations Through Innovative Resource Characterisation. [https://era.daf.qld.gov.au/id/eprint/7939/1/Final\\_Report\\_Southern\\_Pines\\_PNC361-1416.pdf](https://era.daf.qld.gov.au/id/eprint/7939/1/Final_Report_Southern_Pines_PNC361-1416.pdf).
- Balasbaneh, A. T., and A. K. B. Marsono. 2017. "Strategies for Reducing Greenhouse Gas Emissions from Residential Sector by Proposing New Building Structures in Hot and Humid Climatic Conditions." *Building & Environment* 124:357–368. <https://doi.org/10.1016/j.buildenv.2017.08.025>.
- Buksnowitz, C., C. Hackspiel, K. Hofstetter, U. Müller, W. Gindl, A. Teischinger, and J. Konnerth. 2010. "Knots in Trees: Strain Distribution in a Naturally Optimised

- Structure.” *Wood Science and Technology* 44 (3): 389–398. <https://doi.org/10.1007/s00226-010-0352-4>.
- Cherry, R., W. Karunasena, and A. Manalo. 2022. “Mechanical Properties of Low-Stiffness Out-Of-Grade Hybrid Pine—Effects of Knots, Resin and Pith.” *Forests* 13 (6): 927. <https://doi.org/10.3390/f13060927>.
- Cherry, R., A. Manalo, W. Karunasena, and G. Stringer. 2019. “Out-Of-Grade Sawn Pine: A State-Of-The-Art Review on Challenges and New Opportunities in Cross Laminated Timber (CLT).” *Construction and Building Materials* 211:858–868. <https://doi.org/10.1016/j.conbuildmat.2019.03.293>.
- da Rosa Azambuja, R., D. B. DeVallance, and J. McNeel. 2022. “Evaluation of Low-Grade Yellow-Poplar (*Liriodendron Tulipifera*) as Raw Material for Cross-Laminated Timber Panel Production.” *Forest Products Journal* 72 (1): 1–10. <https://doi.org/10.13073/FPJ-D-21-00050>.
- da Rosa Azambuja, R., D. B. DeVallance, J. McNeel, and G. A. Dahle. 2023. “Cross-Laminated Timber Panels Produced from Low-Grade Yellow-Poplar Sorted by Structural Visual Grade.” *Forest Products Journal* 73 (2): 104–112. <https://doi.org/10.13073/FPJ-D-22-00074>.
- Derikvand, M., H. Jiao, N. Kotlarewski, M. Lee, A. Chan, and G. Nolan. 2019. “Bending Performance of Nail-Laminated Timber Constructed of Fast-Grown Plantation Eucalypt.” *European Journal of Wood and Wood Products* 77 (3): 421–437. <https://doi.org/10.1007/s00107-019-01408-9>.
- Derikvand, M., N. Kotlarewski, M. Lee, H. Jiao, A. Chan, and G. Nolan. 2019. “Short-Term and Long-Term Bending Properties of Nail-Laminated Timber Constructed of Fast-Grown Plantation Eucalypt.” *Construction and Building Materials* 211:952–964. <https://doi.org/10.1016/j.conbuildmat.2019.03.305>.
- Falk, R. H., and F. Colling. 1995. “Laminating Effects in Glued-Laminated Timber Beams.” *Journal of Structural Engineering* 121 (12): 1857–1863. [https://doi.org/10.1061/\(ASCE\)0733-9445\(1995\)121:12\(1857\)](https://doi.org/10.1061/(ASCE)0733-9445(1995)121:12(1857)).
- Fink, G., G. Ruan, and G. H. Filz. 2019. “Sustainable Design Concepts for Short Span, Timber-Only Structures.” Proceedings of IASS Annual Symposia, volume 2019, International Association for Shell and Spatial Structures (IASS), Barcelona, Spain, 1–8.
- Foliente, G. C. 2000. *History of Timber Construction, In: Wood Structures: A Global Forum on the Treatment, Conservation, and Repair of Cultural Heritage*. West Conshohocken, PA, USA: ASTM International.
- Gilbert, B. P., H. Bailleres, H. Zhang, and R. L. McGavin. 2017. “Strength Modelling of Laminated Veneer Lumber (LVL) Beams.” *Construction and Building Materials* 149:763–777. <https://doi.org/10.1016/j.conbuildmat.2017.05.153>.
- Harding, K. 2009). URL: Resource Characterisation of Slash Pine Plantation Wood Quality.” [https://era.daf.qld.gov.au/id/eprint/3144/2/PN06.3016SlashpineResourceEvaluation2009\[1\]-sec.pdf](https://era.daf.qld.gov.au/id/eprint/3144/2/PN06.3016SlashpineResourceEvaluation2009[1]-sec.pdf).
- Herberg, E. L. 2018. *Flexural Performance of Nail-Laminated Timber Crane Mats*. Ph.D. thesis, University of Minnesota.
- Hosseini, S. M., and A. Peer. 2022. “Wood Products Manufacturing Optimization: A Survey.” *Institute of Electrical and Electronics Engineers Access* 10:121653–121683. <https://doi.org/10.1109/ACCESS.2022.3223053>.
- Janowiak, J. J., R. H. Falk, B. A. Gething, and J. A. Tsirigotis. 2014. “Mechanical Performance of Nail-Laminated Posts Manufactured from Reclaimed Chromated Copper Arsenate-Treated Decking Lumber.” *Forest Products Journal* 64 (1–2): 55–63. <https://doi.org/10.13073/FPJ-D-12-00076>.
- Jiang, J., L.-M. Ottenhaus, and J. M. Gattas. 2023. “A Parametric Design Framework for Timber Framing Span Tables.” *Australian Journal of Civil Engineering*: 1–16. <https://doi.org/10.1080/14488353.2023.2227432>.
- Johansson, M., and R. Kliger. 2002. “Influence of Material Characteristics on Warp in Norway Spruce Studs.” *Wood and Fiber Science* 34:325–336.
- Kandler, G., J. Füssl, E. Serrano, and J. Eberhardsteiner. 2015. “Effective Stiffness Prediction of GLT Beams Based on Stiffness Distributions of Individual Lamellas.” *Wood Science and Technology* 49 (6): 1101–1121. <https://doi.org/10.1007/s00226-015-0745-5>.
- Lee, J. J., J. S. Park, K. M. Kim, and J. K. Oh. 2005. “Prediction of Bending Properties for Structural Glulam Using Optimized Distributions of Knot Characteristics and Laminar Moe.” *Journal of Wood Science* 51 (6): 640–647. <https://doi.org/10.1007/s10086-005-0704-0>.
- Lerm, F. J., M. Blumentritt, W. H. Brink, and C. B. Wessels. 2017. “A Method for Three-Dimensional Stem Analysis and Its Application in a Study on the Occurrence of Resin Pockets in *Pinus Patula*.” *European Journal of Forest Research* 136 (3): 411–420. <https://doi.org/10.1007/s10342-017-1041-8>.
- Li, J., B. Rismanchi, and T. Ngo. 2019. “Feasibility Study to Estimate the Environmental Benefits of Utilising Timber to Construct High-Rise Buildings in Australia.” *Building & Environment* 147:108–120. <https://doi.org/10.1016/j.buildenv.2018.09.052>.
- Li, X., M. Ashraf, M. Subhani, P. Kremer, B. Kafle, and K. Ghabraie. 2020. “Experimental and Numerical Study on Bending Properties of Heterogeneous Lamella Layups in Cross Laminated Timber Using Australian Radiata Pine.” *Construction and Building Materials* 247:118525. <https://doi.org/10.1016/j.conbuildmat.2020.118525>.
- Martitegui, F. A., M. E. Herrero, R. A. Álvarez, I. B. Maldonado, and G. Í. González. 2007. “The Effect of Waness on the Bending Strength of Solid Timber Beams.” *Materiales de Construcción* 57:61–76. <https://doi.org/10.3989/mc.2007.v57.i288.65>.
- Nicoletta, T., M. Valdés, B. De Nicolo, and M. Fragiaco. 2017. “Grading of Low-Quality Wood for Use in Structural Elements.” *Wood in Civil Engineering* 1:3–24. <https://doi.org/10.5772/67129>.
- Rose, C. M., D. Bergsagel, T. Dufresne, E. Unubreme, T. Lyu, P. Duffour, and J. A. Stegemann. 2018. “Cross-Laminated Secondary Timber: Experimental Testing and Modelling the Effect of Defects and Reduced Feedstock Properties.” *Sustainability* 10 (11): 4118. <https://doi.org/10.3390/su10114118>.
- Sigrist, C., and M. Lehmann. 2014. “Potential of CLT Produced from Non-Structural Grade Australian *Pinus Radiata*.” World Conference on Timber Engineering 2014, Quebec, Canada.
- Standards Australia, Residential Timber Framed Construction, as 1684, 2010b*. Sydney, AU.

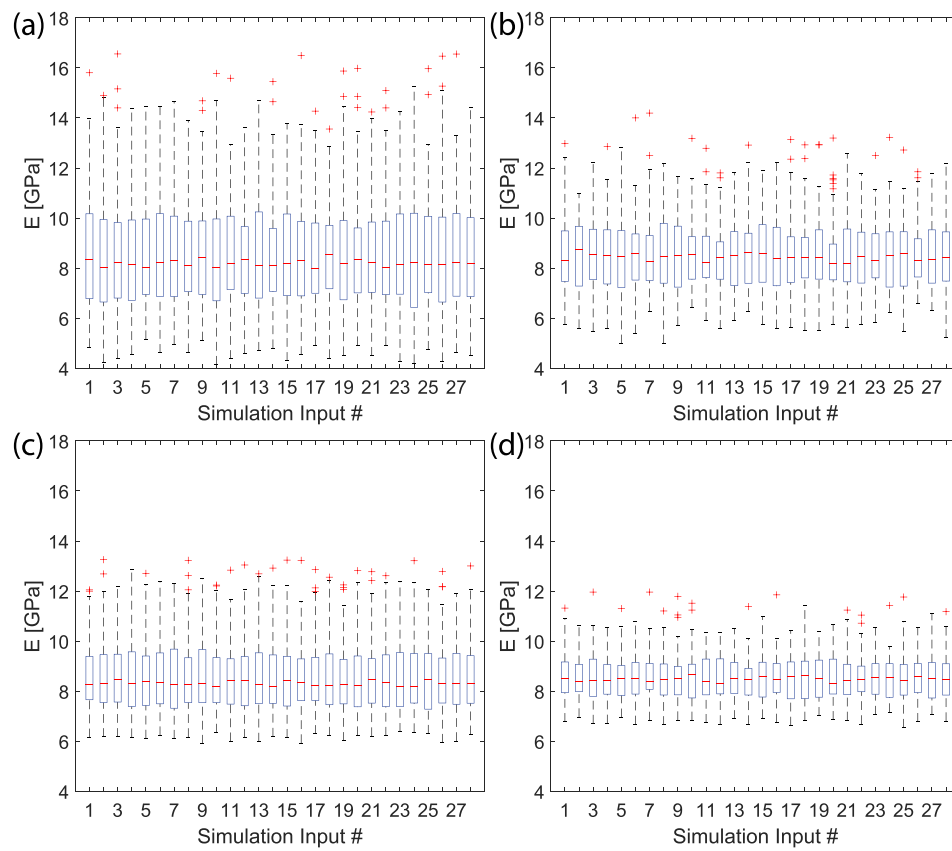

- Taoum, A., H. Jiao, D. Holloway, and J. Shanks. 2019. "Behaviour of Locally Post-Tensioned Nail Laminated High Mass Floor Panels Under Serviceability Loads." *Australian Journal of Structural Engineering* 20 (2): 115–123. <https://doi.org/10.1080/13287982.2019.1607447>.
- Thomas, D., and G. Ding. 2018. "Comparing the Performance of Brick and Timber in Residential Buildings—The Case of Australia." *Energy & Buildings* 159:136–147. <https://doi.org/10.1016/j.enbuild.2017.10.094>.
- Vestøl, G. I., and O. Høibø. 2010. "Bending Strength and Modulus of Elasticity of Squares with Wane as Compared with Round Timber of Scots Pine (*Pinus Sylvestris*)." *Forest Products Journal* 60 (1): 40–47. <https://doi.org/10.13073/0015-7473-60.1.40>.
- Wilson, D. E. 2012. *Structural Properties of ICLT Wall Panels Composed of Beetle Killed Wood*. Brigham Young University.
- Yang, B., R. Seale, R. Shmulsky, J. Dahlen, and X. Wang. 2015. "Comparison of Nondestructive Testing Methods for Evaluating No. 2 Southern Pine Lumber: Part A, Modulus of Elasticity." *Wood and Fiber Science* 47 (4): 375–384.

**Appendix A1. Monte Carlo simulation results**

**Figure A1.** Monte Carlo simulation of production order, first 30 of 500 samples. Randomised (a) pair and (b) quad laminations. High/low (c) pair and (d) quad laminations.