

Reference point management and the role of catch-per-unit effort in prawn and scallop fisheries

Michael F. O'Neill, Anthony J. Courtney, Norm M. Good,
Clive T. Turnbull, Kate M. Yeomans, Jonathan Staunton-Smith and
Celeste Shootingstar



Queensland
Government
Department of
**Primary Industries
and Fisheries**



**F I S H E R I E S
R E S E A R C H &
D E V E L O P M E N T
C O R P O R A T I O N**

Project No. 1999/120

QQ 05001
ISSN 0727-6281

Reference point management and the role of catch-per-unit effort in prawn and scallop fisheries

Michael F. O'Neill, Anthony J. Courtney, Norm M. Good,
Clive T. Turnbull, Kate M. Yeomans, Jonathan Staunton-Smith and Celeste Shootingstar

© The State of Queensland, Department of Primary Industries and Fisheries;
Fisheries Research and Development Corporation, 2005

Copyright protects this publication. The State of Queensland has no objection to this material being reproduced but asserts its right to be recognised as author of its original material and the right to have its material remain unaltered.

Except as permitted under the *Copyright Act 1968 (Cth)*, no part of this publication may be reproduced by any process, electronic or otherwise, without the specific written permission of the copyright owners. Neither may information be stored electronically in any form whatsoever without such permission.

The authors do not warrant that the information in this book is free from errors or omissions. The authors do not accept any form of liability, be it contractual, tortious or otherwise, for the contents of this book or for any consequences arising from its use or any reliance placed upon it. The information, opinions and advice contained in this book may not relate to, or be relevant to, a reader's particular circumstances. Opinions expressed by the authors are the individual opinions of those persons and are not necessarily those of the publisher or research provider.

Inquiries should be addressed to:
Manager, DPI&F Publications
Department of Primary Industries
GPO Box 46
Brisbane Qld 4001

Table of Contents

1	NON-TECHNICAL SUMMARY	1
2	BACKGROUND	4
3	NEED	6
4	OBJECTIVES	7
5	OBJECTIVE 1. PRODUCE AN IN-DEPTH DESCRIPTION OF THE GEAR AND TECHNOLOGICAL IMPROVEMENTS OF A REPRESENTATIVE SAMPLE FOR THE A) TORRES STRAIT TIGER PRAWN, B) QUEENSLAND EASTERN KING PRAWN AND C) SOUTH-EAST QUEENSLAND SAUCER SCALLOP FISHERIES FOR THE PERIOD 1970 TO PRESENT.	8
5.1	ABSTRACT	8
5.2	INTRODUCTION	9
5.3	MATERIALS AND METHODS	10
5.4	RESULTS	12
5.4.1	<i>Trends in skippering vessels</i>	12
5.4.2	<i>Changes in general vessel characteristics</i>	12
5.4.3	<i>Try gear</i>	16
5.4.4	<i>Changes in trawl gear</i>	17
5.4.5	<i>Uptake of turtle excluder devices and bycatch reduction devices</i>	25
5.4.6	<i>Changes in navigational technology</i>	25
5.4.7	<i>Changes in communication technology</i>	26
5.5	DISCUSSION	29
5.5.1	<i>General vessel characteristics</i>	29
5.5.2	<i>Changes in nets, ground chains and otter boards</i>	30
5.5.3	<i>Uptake of TEDs and BRDs</i>	30
5.5.4	<i>Navigational improvements</i>	31
5.5.5	<i>Changes in communication</i>	31
5.6	REFERENCES	32
6	OBJECTIVE 2. ESTABLISH A STANDARDISED CATCH-PER-UNIT EFFORT SERIES: COMPARISON OF RELATIVE FISHING POWER BETWEEN DIFFERENT SECTORS OF THE QUEENSLAND TRAWL FISHERY, AUSTRALIA	33
6.1	ABSTRACT	33
6.2	INTRODUCTION	33
6.3	MATERIALS AND METHODS	36

6.3.1	<i>Catch Data</i>	36
6.3.2	<i>Fishing gear and technology data</i>	36
6.3.3	<i>Statistical analysis</i>	37
6.3.4	<i>Estimating relative fishing power</i>	38
6.4	RESULTS	39
6.4.1	<i>Summary of fishing gears and technologies</i>	39
6.4.2	<i>Analysis of prawn and scallop catches</i>	41
6.4.3	<i>Estimates of Fishing Power</i>	46
6.5	DISCUSSION	49
6.5.1	<i>Fishing power</i>	49
6.5.2	<i>Stock assessment</i>	51
6.5.3	<i>Statistical comments</i>	51
6.5.4	<i>Conclusion</i>	52
6.6	FURTHER DEVELOPMENT	52
6.7	ACKNOWLEDGMENTS.....	52
6.8	REFERENCES	53
7	OBJECTIVE 3. COMPARE PRESENT MANAGEMENT PLAN REFERENCE POINTS WITH THE ADJUSTED AND UNADJUSTED CATCH-PER-UNIT EFFORT SERIES	55
7.1	ABSTRACT	55
7.2	INTRODUCTION	55
7.2.1	<i>Current Queensland reference points</i>	56
7.3	METHODS.....	57
7.3.2	<i>Chart interpretation</i>	58
7.4	RESULTS	59
7.4.1	<i>Review charts based on average over all months within period.</i>	59
7.4.2	<i>Review period charts based on each month within a period.</i>	67
7.5	DISCUSSION.....	76
7.6	REFERENCES	76
8	OBJECTIVE 4. INVESTIGATE AND ESTABLISH ROBUST REFERENCE POINTS AND RESPONSE MECHANISMS THROUGH SIMULATION	77
8.1	ABSTRACT	77

8.2	INTRODUCTION	77
8.3	METHODS.....	81
8.3.1	<i>Catch and Effort Data</i>	81
8.3.2	<i>Standardisation of Catch Rates</i>	83
8.3.3	<i>Delay Difference Modelling</i>	85
8.3.4	<i>Age Structured Modelling</i>	88
8.3.5	<i>Surplus Production Modelling</i>	91
8.3.6	<i>Statistical Uncertainty in Models</i>	92
8.3.7	<i>Historical Trawl Data</i>	94
8.3.8	<i>Spawner-recruitment Relationships</i>	97
8.3.9	<i>Equilibrium Reference Points</i>	99
8.3.10	<i>Reference Point Simulations</i>	101
8.4	RESULTS	111
8.4.1	<i>Eastern King Prawns</i>	111
8.4.2	<i>Torres Strait Tiger Prawns</i>	126
8.4.3	<i>Saucer Scallops</i>	139
8.5	DISCUSSION	157
8.5.1	<i>Reference Points</i>	157
8.5.2	<i>Stock Assessment and Future Development</i>	159
8.5.3	<i>Modelling</i>	165
8.6	REFERENCES	167
9	CONCLUSION	172
10	BENEFITS AND ADOPTION	175
11	FURTHER DEVELOPMENT	176
12	ACKNOWLEDGMENTS	176
13	INTELLECTUAL PROPERTY	177
14	STAFF	177
15	APPENDICES	178
15.1	REFERENCE POINT RESULTS FOR 5 AND 20 YEAR PROJECTIONS.....	178
15.1.1	<i>Eastern King Prawns</i>	178
15.1.2	<i>Torres Strait Tiger Prawns</i>	191
15.1.3	<i>Saucer Scallops</i>	212
15.2	GOODNESS OF FIT PLOTS FOR CHAPTER 6.....	241
	QUESTIONNAIRE	244

Figures

FIGURE 5.4.1 THE PROPORTION OF DIFFERENT SKIPPER-TYPES (OWNER, FAMILY MEMBER OR NON-FAMILY MEMBER) OVER TIME IN THE MAJOR QUEENSLAND EAST COAST TRAWL SECTORS.....	12
FIGURE 5.4.2 LONG-TERM TRENDS IN GENERAL VESSEL CHARACTERISTICS IN THE QUEENSLAND EAST COAST AND TORRES STRAIT TRAWL FISHERIES.....	14
FIGURE 5.4.3 PROPELLER WITH NOZZLE, FROM QUEENSLAND EAST COAST TRAWLER. .	15
FIGURE 5.4.4 LONG-TERM TRENDS IN THE PROPORTION OF VESSELS USING PROPELLER NOZZLES IN THE QUEENSLAND EAST COAST AND TORRES STRAIT TRAWL FISHERIES.....	15
FIGURE 5.4.5 BEAM TRAWL TRY GEAR ON BOARD VESSELS IN THE EASTERN KING PRAWN FISHERY.	16
FIGURE 5.4.6 THE PROPORTION OF VESSELS USING TRY GEAR IN THE MAJOR TRAWL SECTORS OF THE QUEENSLAND EAST COAST AND TORRES STRAIT FROM 1960-2000, BASED ON RESULTS FROM THE QUESTIONNAIRE.	16
FIGURE 5.4.7 THE PROPORTION OF VESSELS USING TRY GEAR AT DIFFERENT FREQUENCIES THROUGHOUT THE NIGHT IN THE NORTH QUEENSLAND TIGER/ENDEAVOUR PRAWN FISHERY.	17
FIGURE 5.4.8 CHANGES IN THE CONFIGURATION OF NETS USED IN EACH OF THE MAJOR QUEENSLAND TRAWL SECTORS FROM 1960 TO 2000, BASED ON THE QUESTIONNAIRE RESULTS.....	18
FIGURE 5.4.9 TIME SERIES OF THE AVERAGE TOTAL HEAD ROPE LENGTH OF NETS IN EACH OF THE QUEENSLAND TRAWL SECTORS FROM 1960-2000, BASED ON THE QUESTIONNAIRE RESULTS.....	19
FIGURE 5.4.10 PHOTOGRAPH OF ‘DROP CHAIN’ – THE MOST COMMON GROUND CHAIN TYPE USED IN THE QUEENSLAND EAST COAST AND TORRES STRAIT TRAWL SECTORS.....	20
FIGURE 5.4.11 TYPES OF GROUND CHAIN USED IN THE DIFFERENT TRAWL SECTORS FROM 1960 TO 2000, BASED ON RESULTS FROM THE QUESTIONNAIRE.....	22
FIGURE 5.4.12 LONG-TERM TRENDS IN THE AVERAGE GAUGE OF DROP CHAIN USED IN EACH SECTOR, BASED ON RESULTS FROM THE QUESTIONNAIRE.....	23
FIGURE 5.4.13 TYPES OF OTTER BOARDS USED IN THE QUEENSLAND EAST COAST TRAWL FISHERY. ABOVE IS LARGE FLAT OTTER BOARD WITH SKID, AS USED IN TRIPLE GEAR IN DEEP WATER EASTERN KING PRAWN FISHERY. BELOW ARE TWO BISON BOARDS WITH SKID IN BETWEEN, USED IN QUAD GEAR IN THE TIGER/ENDEAVOUR PRAWN FISHERY.	23
FIGURE 5.4.14 THE PROPORTION OF VESSELS USING DIFFERENT TYPES OF OTTER BOARDS IN EACH OF THE MAJOR QUEENSLAND TRAWL SECTORS FROM 1960-2000, BASED ON THE QUESTIONNAIRE RESULTS.	24
FIGURE 5.4.15 THE REPORTED USE OF TEDS AND BRDs IN THE TORRES STRAIT AND MAJOR QUEENSLAND EAST COAST TRAWL SECTORS, BASED ON RESULTS FROM THE QUESTIONNAIRE.	25
FIGURE 5.4.16 THE ADOPTION OF NAVIGATIONAL TECHNOLOGIES IN THE MAJOR QUEENSLAND EAST COAST TRAWL SECTORS AND TORRES STRAIT FROM 1969 TO 2000, BASED ON THE QUESTIONNAIRE RESULTS.	27
FIGURE 5.4.17 LONG-TERM TRENDS IN THE ADOPTION OF RADIO AND TELECOMMUNICATION DEVICES IN THE QUEENSLAND EAST COAST AND TORRES STRAIT TRAWL FISHERIES, BASED ON THE QUESTIONNAIRE RESULTS.	28
FIGURE 6.2.1 THE SPATIAL DISTRIBUTION OF AVERAGE ANNUAL CATCH (TONNES) FROM EACH OTTER TRAWL SECTOR, FOR A) THE TORRES STRAIT TIGER PRAWNS, B) THE	

NORTH QUEENSLAND TIGER PRAWNS, C) THE QUEENSLAND SAUCER SCALLOPS AND D) THE QUEENSLAND EASTERN KING PRAWNS; CLEAR GRIDS REPRESENT THE SHALLOW WATER (< 50 FATHOMS) SECTOR, SHADED GRIDS REPRESENT THE DEEP WATER (> 50 FATHOMS) SECTOR. ONLY DATA WITHIN THE GRIDS ILLUSTRATED WERE USED IN THE ANALYSIS.	35
FIGURE 6.4.1 SUMMARY OF AVERAGE FLEET CHARACTERISTICS BY FISHING YEAR AND TRAWL SECTOR. PLOTS A, B, C, D, E, F AND K ARE WEIGHTED MEANS ACCORDING TO THE NUMBER OF DAYS FISHED BY EACH VESSEL IN EACH FISHING YEAR AND SECTOR. PLOTS G, H, I, J AND L REPRESENT THE PERCENT OF FISHING EFFORT (BOAT DAYS) IN EACH FISHING YEAR AND SECTOR USING THAT PARTICULAR DEVICE.	40
FIGURE 6.4.2 SUMMARY OF TORRES STRAIT TIGER PRAWN AVERAGE FLEET CHARACTERISTICS FROM 1980 TO 2002. THE PLOTS ARE WEIGHTED MEANS ACCORDING TO THE NUMBER OF DAYS FISHED BY EACH VESSEL IN EACH FISHING YEAR. NOTE LOW VESSEL NUMBERS FOR GEAR BOX RATIO PRIOR TO 1988.	41
FIGURE 6.4.3 COMPARISON OF FISHING POWER INCREASES FOR TORRES STRAIT TIGER PRAWNS USING GENERALISED LINEAR MODEL PARAMETER ESTIMATES FROM ANALYSING A) 1982 TO 2000 CATCH RATES AND B) 1989 TO 1999 CATCH RATES. ESTIMATES OF FISHING POWER INCREASES WERE NOT SIGNIFICANTLY DIFFERENT WITH OVERLAPPING ESTIMATES AND CONFIDENCE INTERVALS.	48
FIGURE 6.4.4 COMPARISON OF NOMINAL UNSTANDARDISED (RAW DATA) AND FISHING POWER STANDARDISED ANNUAL AVERAGE CATCH RATES (CPUE = CATCH-PER-VESSEL DAY).	48
FIGURE 7.4.1 COMPARISON OF NOMINAL CPUE WITH 70% CPUE FOR SCALLOPS (ALL GRIDS). REVIEW EVENTS WERE TRIGGERED FOR THE 97–98 AND 99–00 FISHING SEASON.	59
FIGURE 7.4.2 COMPARISON OF STANDARDISED CPUE WITH 70% CPUE FOR SCALLOPS (ALL GRIDS). REVIEW EVENTS WERE TRIGGERED FOR THE 97–98 AND 99–00 FISHING SEASON.	59
FIGURE 7.4.3 COMPARISON OF NOMINAL CPUE WITH 70% CPUE FOR SCALLOPS (SCALLOP GRIDS). THERE WAS A 50% CHANCE OF TRIGGERING A REVIEW EVENT IN THE 97–98 FISHING SEASON.	60
FIGURE 7.4.4 COMPARISON OF STANDARDISED CPUE WITH 70% CPUE FOR SCALLOPS (SCALLOP GRIDS). THERE WAS A 68% CHANCE OF TRIGGERING A REVIEW EVENT IN THE 97–98 FISHING SEASON.	60
FIGURE 7.4.5 COMPARISON OF NOMINAL CPUE WITH 70% CPUE FOR EASTERN KING PRAWN (DEEP GRIDS). NO REVIEW EVENTS WERE TRIGGERED.	61
FIGURE 7.4.6 COMPARISON OF STANDARDISED CPUE WITH 70% CPUE FOR EASTERN KING PRAWN (DEEP GRIDS). NO REVIEW EVENTS WERE TRIGGERED.	61
FIGURE 7.4.7 COMPARISON OF NOMINAL CPUE WITH 70% CPUE FOR EASTERN KING PRAWN (SHALLOW GRIDS). NO REVIEW EVENTS WERE TRIGGERED.	62
FIGURE 7.4.8 COMPARISON OF STANDARDISED CPUE WITH 70% CPUE FOR EASTERN KING PRAWN (SHALLOW GRIDS). NO REVIEW EVENTS WERE TRIGGERED. HOWEVER, IN THE 99–00 FISHING YEAR THERE WAS A 17% LIKELIHOOD OF CATCH-RATES FALLING BELOW THE 70% LIMIT REFERENCE POINT.	62
FIGURE 7.4.9 COMPARISON OF NOMINAL CPUE WITH 70% CPUE FOR EASTERN KING PRAWN (ALL GRIDS, DEEP MONTHS). NO REVIEW EVENTS WERE TRIGGERED.	63
FIGURE 7.4.10 COMPARISON OF STANDARDISED CPUE WITH 70% CPUE FOR EASTERN KING PRAWN (ALL GRIDS, DEEP MONTHS). NO REVIEW EVENTS WERE TRIGGERED.	63

FIGURE 7.4.11 COMPARISON OF NOMINAL CPUE WITH 70% CPUE FOR EASTERN KING PRAWN (ALL GRIDS, SHALLOW MONTHS). NO REVIEW EVENTS WERE TRIGGERED.	64
FIGURE 7.4.12 COMPARISON OF STANDARDISED CPUE WITH 70% CPUE FOR EASTERN KING PRAWN (ALL GRIDS, SHALLOW MONTHS). NO REVIEW EVENTS WERE TRIGGERED. HOWEVER IN THE 99–00 FISHING YEAR THERE WAS A 22% LIKELIHOOD OF CATCH-RATES FALLING BELOW THE 70% LIMIT REFERENCE POINT.	64
FIGURE 7.4.13 COMPARISON OF NOMINAL CPUE WITH 70% CPUE FOR NQ TIGER PRAWN (NQ GRIDS, SEP–DEC). NO REVIEW EVENTS WERE TRIGGERED.	65
FIGURE 7.4.14 COMPARISON OF STANDARDISED CPUE WITH 70% CPUE FOR NQ TIGER PRAWN (NQ GRIDS, SEP–DEC). NO REVIEW EVENTS WERE TRIGGERED. HOWEVER, IN THE 2000 FISHING YEAR THERE WAS A 23% LIKELIHOOD OF CATCH-RATES FALLING BELOW THE 70% LIMIT REFERENCE POINT.	65
FIGURE 7.4.15 COMPARISON OF NOMINAL CPUE WITH 70% CPUE FOR NQ TIGER PRAWN (NQ GRIDS, MAR–JUN). NO REVIEW EVENTS WERE TRIGGERED. HOWEVER, IN THE 2000 FISHING YEAR THERE WAS A 13% LIKELIHOOD OF CATCH-RATES FALLING BELOW THE 70% LIMIT REFERENCE POINT.	66
FIGURE 7.4.16 COMPARISON OF STANDARDISED CPUE WITH 70% CPUE FOR NQ TIGER PRAWN (NQ GRIDS, MAR–JUN). NO REVIEW EVENTS WERE TRIGGERED. HOWEVER, IN THE 2000 FISHING YEAR THERE WAS A 24% LIKELIHOOD OF CATCH-RATES FALLING BELOW THE 70% LIMIT REFERENCE POINT.	66
FIGURE 7.4.17 COMPARISON OF MONTHLY NOMINAL CPUE WITH 70% CPUE FOR SCALLOPS (ALL GRIDS). REVIEW EVENTS WERE TRIGGERED FOR THREE OUT OF FOUR MONTHS IN THE 97–98 AND 02–03 FISHING SEASON, TWICE IN THE 99–00 FISHING SEASON, ONCE IN THE 00–01 AND 01–02 FISHING SEASON, BUT NOT IN THE 98–99 FISHING SEASON.	67
FIGURE 7.4.18 COMPARISON OF MONTHLY STANDARDISED CPUE WITH 70% CPUE FOR SCALLOPS (ALL GRIDS). REVIEW EVENTS WERE TRIGGERED FOR ALL MONTHS IN THE 99–00 FISHING SEASON, THREE OUT OF FOUR MONTHS IN THE 97–98 AND 02–03 FISHING SEASON, ONCE IN THE 00–01 AND 01–02 FISHING SEASON, BUT NOT IN THE 98–99 FISHING SEASON.	67
FIGURE 7.4.19 COMPARISON OF MONTHLY NOMINAL CPUE WITH 70% CPUE FOR SCALLOPS (SCALLOP GRIDS). REVIEW EVENTS WERE TRIGGERED FOR THREE OUT OF FOUR MONTHS IN THE 97–98 FISHING SEASON, TWICE IN THE 99–00 FISHING SEASON, ONCE IN THE 02–03 FISHING SEASON, BUT NOT IN THE 98–99, 00–01 AND 01–02 FISHING SEASON.	68
FIGURE 7.4.20 COMPARISON OF MONTHLY STANDARDISED CPUE WITH 70% CPUE FOR SCALLOPS (SCALLOP GRIDS). REVIEW EVENTS WERE TRIGGERED FOR THREE OUT OF FOUR MONTHS IN THE 97–98 FISHING SEASON, TWICE IN THE 99–00 AND 02–03 FISHING SEASON. HOWEVER, IN BOTH LATER CASES THEY FAIL TO REACH THE REQUIRED 50% BY LESS THAN 2%. NO OTHER MONTHS WITHIN FISHING SEASONS TRIGGER A REVIEW EVENT.	68
FIGURE 7.4.21 COMPARISON OF MONTHLY NOMINAL CPUE WITH 70% CPUE FOR EKP (DEEP GRIDS). NO REVIEW EVENTS WERE TRIGGERED FOR ANY FISHING YEAR.	69
FIGURE 7.4.22 COMPARISON OF MONTHLY STANDARDISED CPUE WITH 70% CPUE FOR EKP (DEEP GRIDS). NO REVIEW EVENTS WERE TRIGGERED IN ANY FISHING SEASON.	70
FIGURE 7.4.23 COMPARISON OF MONTHLY NOMINAL CPUE WITH 70% CPUE FOR EKP (SHALLOW GRIDS). NO REVIEW EVENTS WERE TRIGGERED IN ANY FISHING SEASON.	70

FIGURE 7.4.24 COMPARISON OF MONTHLY STANDARDISED CPUE WITH 70% CPUE FOR EKP (SHALLOW GRIDS). CATCH-RATES FELL BELOW THE 70% LIMIT REFERENCE POINT IN DECEMBER 1999 ONLY. NO OTHER REVIEW EVENTS WERE TRIGGERED IN ANY FISHING SEASON.	71
FIGURE 7.4.25 COMPARISON OF MONTHLY NOMINAL CPUE WITH 70% CPUE FOR EKP (ALL GRIDS, DEEP MONTHS). NO REVIEW EVENTS WERE TRIGGERED IN ANY FISHING SEASON.	71
FIGURE 7.4.26 COMPARISON OF MONTHLY STANDARDISED CPUE WITH 70% CPUE FOR EKP (ALL GRIDS, DEEP MONTHS). NO REVIEW EVENTS WERE TRIGGERED IN ANY FISHING SEASON.	72
FIGURE 7.4.27 COMPARISON OF MONTHLY NOMINAL CPUE WITH 70% CPUE FOR EKP (ALL GRIDS, SHALLOW MONTHS). NO REVIEW EVENTS WERE TRIGGERED IN ANY FISHING SEASON.	72
FIGURE 7.4.28 COMPARISON OF MONTHLY STANDARDISED CPUE WITH 70% CPUE FOR EKP (ALL GRIDS, SHALLOW MONTHS). A REVIEW EVENT WAS TRIGGERED FOR NOVEMBER AND DECEMBER 1999. NO REVIEW EVENTS WERE TRIGGERED IN ANY OTHER FISHING SEASON.	73
FIGURE 7.4.29 COMPARISON OF MONTHLY NOMINAL CPUE WITH 70% CPUE FOR NQ TIGER (MAR–JUN). NO REVIEW EVENTS WERE TRIGGERED IN ANY FISHING SEASON.	74
FIGURE 7.4.30 COMPARISON OF MONTHLY STANDARDISED CPUE WITH 70% CPUE FOR NQ TIGER (MAR-JUN). NO REVIEW EVENTS WERE TRIGGERED IN ANY FISHING SEASON. THERE WAS A 42% PROBABILITY OF TRIGGERING A REVIEW EVENT IN MARCH 2000.	74
FIGURE 7.4.31 COMPARISON OF MONTHLY NOMINAL CPUE WITH 70% CPUE FOR NQ TIGER (SEP-DEC). NO REVIEW EVENTS WERE TRIGGERED IN ANY FISHING SEASON.	75
FIGURE 7.4.32 COMPARISON OF MONTHLY STANDARDISED CPUE WITH 70% CPUE FOR NQ TIGER (SEP-DEC). A REVIEW EVENT WAS TRIGGERED IN DECEMBER 2000 AND A 45% PROBABILITY OF TRIGGERING A REVIEW EVENT IN NOVEMBER 2000.	75
FIGURE 8.3.9.1 ILLUSTRATIVE (HYPOTHETICAL) EXAMPLE SHOWS HOW THE VARIOUS REFERENCE POINTS MAY RELATE. MAXIMUM SUSTAINABLE YIELD IS THE LARGEST REFERENCE SHOWN BY THE RIGHT-HAND DOTTED LINE, THE NEXT SMALLEST IS 3/4 OF MSY EFFORT, THEN 2/3 OF MSY EFFORT. IN THIS EXAMPLE, $F_{0.1}$ IS SIMILAR TO 2/3 OF MSY EFFORT.	100
FIGURE 8.3.10.1 FLOW DIAGRAM ILLUSTRATING THE SIMULATION APPROACH. THE OPERATING MODEL REPRESENTS THE POPULATION DYNAMICS WHERE FISHING IS APPLIED AND THE DYNAMICS ARE CALCULATED (I.E. MONTHLY POPULATION SIZES, CATCHES, CATCH RATES ETC). THE ASSESSMENT MODEL REPRESENTS US CONDUCTING STOCK ASSESSMENTS USING MODELS EVERY TWO YEARS OR CATCH-RATES EVERY YEAR AND THEN APPLYING A FISHING EFFORT STRATEGY BASED ON THE RESULTS. THE PROCESS WAS CIRCULAR FOR TWENTY YEARS AND THE OUTPUTS FOR EACH YEAR WERE RECORDED FOR A NUMBER OF PERFORMANCE MEASURES (E.G. RISKS OF OVER FISHING, EXPECTED CATCHES ETC; DEFINED PAGE 106).	102
FIGURE 8.3.10.2 ILLUSTRATING THE FISHING MORTALITY REFERENCE POINT CONTROL RULES.	105
FIGURE 8.3.10.3 FLOW DIAGRAM DESCRIBING THE REFERENCE POINT SIMULATION PROCESS.	107

FIGURE 8.4.1.1 QUEENSLAND AND NEW SOUTH WALES EASTERN KING PRAWN CATCHES AND FISHING EFFORT FROM 1989 TO 2001; NOTE THE LARGE TOTAL CATCH TAKEN IN 2001.	111
FIGURE 8.4.1.2 QUEENSLAND AND NEW SOUTH WALES MONTHLY STANDARDISED CATCH RATES FROM NOVEMBER 1988 TO DECEMBER 2001; NOTE THE SIMILAR CYCLES BETWEEN STATES AND THE HIGH CATCH RATES REPORTED IN QUEENSLAND FOR 2001.....	112
FIGURE 8.4.1.3 HISTOLOGICAL STAGING OF FEMALE EASTERN KING PRAWNS SHOWED THAT THE RELATIVE PROPORTION OF SPAWNING WAS HIGHER BETWEEN MAY AND OCTOBER. THE DOTTED LINES ARE 90% CONFIDENCE INTERVALS. THE MONTHS ARE PRESENTED IN ORDER OF A FISHING YEAR. BASED ON DATA FROM (COURTNEY 1997).	113
FIGURE 8.4.1.4 THE MONTHLY DELAY DIFFERENCE MODEL PREDICTED STABLE EXPLOITABLE BIOMASSES FOR THE EASTERN KING PRAWNS BETWEEN 1989 AND 2000 FISHING YEARS, WITH A NOTABLE INCREASE IN 2001 (DOTTED LINES REPRESENT THE 90TH PERCENTILES). THE RESULTS WERE PRESENTED FOR VARIATIONS IN FISHING POWER, NATURAL MORTALITY AND STOCK-RECRUITMENT. THE DASHED LINE SHOWS THE BIOMASS REFERENCE POINT FOR MAXIMUM SUSTAINABLE YIELD (B_{MSY}).....	116
FIGURE 8.4.1.5 THE ANNUAL SURPLUS PRODUCTION MODEL PREDICTED STABLE EXPLOITABLE BIOMASSES FOR THE EASTERN KING PRAWNS BETWEEN 1990 AND 2000 FISHING YEARS (DOTTED LINES REPRESENT THE 90TH PERCENTILES). THE DASHED LINE SHOWS THE BIOMASS REFERENCE POINT FOR MAXIMUM SUSTAINABLE YIELD (B_{MSY}).	117
FIGURE 8.4.1.6 EASTERN KING PRAWN SPAWNER-RECRUITMENT RELATIONSHIPS ASSUMING A) NO FISHING POWER INCREASES, B) THE LOWER 90% CONFIDENCE INTERVAL FOR CHANGES IN THE FISHING POWER AND C) THE ACTUAL (BEST KNOWLEDGE) ESTIMATE FOR CHANGES IN THE FISHING POWER. NOTE THE RATE OF FISHING POWER CHANGE LISTED ON B) AND C) WERE ASSUMED PROPORTIONAL RATES APPLIED TO THE FISHING YEARS 1970 TO 1988, BASED ON THE 1989 TO 1999 TREND IN FISHING POWER. ONE-YEAR AUTOCORRELATIONS WERE NON-SIGNIFICANT AT -0.072 ; THE RELATIONSHIPS WERE FIT USING A WEIGHTED LOG-LIKELIHOOD.	117
FIGURE 8.4.1.7 THE DELAY DIFFERENCE (LEFT SIDE) AND SURPLUS PRODUCTION (RIGHT SIDE) MODELS PREDICTED THE OBSERVED STANDARDISED CATCH-RATES WELL A) AND D), AND THE USE OF LOG-NORMAL ERRORS WAS APPROPRIATE WITH NO PATTERN IN STANDARDISED RESIDUALS B) AND E) AND LINEAR NORMALITY PLOTS C) AND F).....	120
FIGURE 8.4.1.8 THE EXPECTED BIOLOGICAL OUTCOMES FOR EASTERN KING PRAWNS FROM MANAGING FISHING EFFORT ACCORDING TO, (A) FISHING MORTALITY, (B) HEAVY ONE-WAY CATCH-RATE, AND (C) MODERATE ONE-WAY CATCH RATE REFERENCE POINTS. THE FIRST TWO ROWS OF PLOTS ILLUSTRATE THE OUTCOMES IN RELATION TO VIRGIN POPULATION SIZE (B_0). OUTCOMES ON THE BOTTOM TWO ROWS WERE MEASURED AGAINST THE POPULATION SIZE WHICH SUPPORTS MAXIMUM SUSTAINABLE YIELD (B_{MSY}). LOWER PROBABILITIES (OR RISKS) OF THE POPULATION SIZES FALLING BELOW $0.2B_0$ AND B_{MSY} WERE FOR FISHING EFFORTS MANAGED AT $2/3$ OF MSY EFFORT OR 80% HEAVY ONE-WAY CATCH-RATES. PROBABILITIES AT 0.5 REPRESENT THE POPULATION SIZES AT $0.2B_0$ AND B_{MSY} RESPECTIVELY. THE ONE-WAY AND TWO-WAY CATCH-RATE MANAGEMENT STRATEGIES PERFORMED ALIKE. THE RESULTS ASSUME BEVERTON-HOLT	

RECRUITMENT; STATUS QUO REPRESENTS 35 000 DAYS OF FISHING EFFORT WITH NO MANAGEMENT CHANGES.....	122
FIGURE 8.4.1.9 THE EXPECTED INDUSTRY OUTCOMES FROM FISHING EASTERN KING PRAWNS AND MANAGING FISHING EFFORT ACCORDING TO, (A) FISHING MORTALITY, (B) HEAVY ONE-WAY CATCH-RATE, AND (C) MODERATE ONE-WAY CATCH-RATE REFERENCE POINTS. INDUSTRY OUTCOMES WERE MEASURED AGAINST MEDIAN TOTAL CATCHES, FISHING EFFORT, CATCH-RATES AND VARIATION IN TOTAL CATCHES (COEFFICIENT OF VARIATION). GENERALLY, THE MANAGEMENT STRATEGIES OF 3/4 AND 2/3 OF MSY FISHING EFFORT PRODUCED LARGER CATCHES AND CATCH-RATES IN THE LONG TERM. VARIATIONS IN TOTAL CATCHES WERE SIMILAR FOR ALL MANAGEMENT STRATEGIES, BUT MUCH LARGER FOR FISHING AT MSY. THE ONE-WAY AND TWO-WAY CATCH-RATE MANAGEMENT STRATEGIES PERFORMED ALIKE. THE RESULTS ASSUME BEVERTON-HOLT RECRUITMENT; STATUS QUO REPRESENTS 35 000 DAYS OF FISHING EFFORT WITH NO MANAGEMENT CHANGES.....	123
FIGURE 8.4.1.10 THE AVERAGE CUMULATIVE NUMBER OF MANAGEMENT CHANGES (LIMIT CATCH-RATE TRIGGERS) FOR THE (A) HEAVY ONE-WAY CATCH-RATE, AND (B) MODERATE ONE-WAY CATCH-RATE REFERENCE POINTS. GENERALLY OVER TWENTY YEARS, BETWEEN ONE AND TWO CATCH-RATE TRIGGERS WILL OCCUR UNDER THE HEAVY ONE-WAY MANAGEMENT STRATEGY, BUT UP TO THREE OR FOUR MAY OCCUR UNDER MODERATE ONE-WAY MANAGEMENT STRATEGY. AGAIN, THE ONE-WAY AND TWO-WAY CATCH-RATE MANAGEMENT STRATEGIES PERFORMED ALIKE. THE RESULTS ASSUME BEVERTON-HOLT RECRUITMENT; STATUS QUO REPRESENTS THE NUMBER OF CATCH-RATES FALLING BELOW 70% CPUE FOR 35 000 DAYS OF FISHING EFFORT WITH NO MANAGEMENT CHANGES.....	124
FIGURE 8.4.1.11 THE DISTRIBUTION OF CPUE REFERENCE POINTS TRIGGERING UNDER A RANGE OF EXPLOITABLE BIOMASSES, EXPRESSED AS A RATIO OF VIRGIN BIOMASSES. THE RESULTS ARE SHOWN FROM THE MONTHLY DELAY DIFFERENCE MODEL FOR 45 000 TEST-FISHING DAYS OF EFFORT, ASSUMING BEVERTON-HOLT RECRUITMENT. THE CATCH-RATE REFERENCE POINTS TRIGGERED MORE FREQUENTLY UNDER THE MODERATE ONE-WAY MANAGEMENT STRATEGY AND TRIGGER AT MARGINALLY LOWER POPULATION SIZES DUE TO THE SLOW RESPONSE OF THIS MANAGEMENT STRATEGY TO CHANGE FISHING EFFORT.....	125
FIGURE 8.4.2.1 THE TORRES STRAIT TIGER AND ENDEAVOUR PRAWN CATCH AND TOTAL FISHING EFFORT RECORDED BETWEEN 1978 AND 2002.	126
FIGURE 8.4.2.2 MONTHLY STANDARDISED TORRES STRAIT TIGER PRAWN CATCH RATES FROM 1980 TO 2002; NOTE THE SEASONAL DECLINES IN CATCH RATES AND THE OVERALL GRADUAL ANNUAL DECLINE. THE GAPS IN CATCH RATES RELATE TO THE THREE-MONTH SEASONAL CLOSURE.	127
FIGURE 8.4.2.3 HISTOLOGICAL STAGING OF FEMALE TIGER PRAWNS IN THE TORRES STRAIT SHOWED NO CLEAR PEAKS IN RELATIVE SPAWNING, BUT WAS MARGINALLY HIGHEST IN JANUARY AND FEBRUARY. THE DOTTED LINES ARE 90% CONFIDENCE INTERVALS.	129
FIGURE 8.4.2.4 THE MONTHLY DELAY DIFFERENCE MODEL PREDICTED DECLINING EXPLOITABLE BIOMASSES FOR TORRES STRAIT TIGER PRAWNS BETWEEN 1980 AND 1994. SINCE 1995, BIOMASSES VARIED AROUND THE BIOMASS REFERENCE POINT FOR MAXIMUM SUSTAINABLE YIELD (B_{MSY} THE DASHED LINE). THE RESULTS WERE PRESENTED FOR THREE VARIATIONS IN NATURAL MORTALITY (M); B_{MSY} CALCULATED FROM RICKER CURVE. THE DOTTED LINES REPRESENT THE 90TH PERCENTILES. ANNUAL MEDIAN INCREASES IN FISHING POWER WERE ASSUMED.	130

FIGURE 8.4.2.5 THE ANNUAL SURPLUS PRODUCTION MODELS PREDICTED DECLINING EXPLOITABLE BIOMASSES FOR TORRES STRAIT TIGER PRAWNS, FOR A) THE FOX FORM OF SURPLUS PRODUCTION USING ALL DATA AND A UNCONSTRAINED LOG-LIKELIHOOD, B) THE FOX FORM OF SURPLUS PRODUCTION USING ALL DATA AND A CONSTRAINED LOG-LIKELIHOOD, C) THE FOX FORM OF SURPLUS PRODUCTION USING ONLY 1989 TO 2002 DATA AND A CONSTRAINED LOG-LIKELIHOOD, AND D) THE SCHAEFER FORM OF SURPLUS PRODUCTION USING ONLY 1989 TO 2002 DATA AND A CONSTRAINED LOG-LIKELIHOOD (THE DOTTED LINES REPRESENT THE 90TH PERCENTILES). THE DASHED LINES SHOW THE BIOMASS REFERENCE POINT FOR MAXIMUM SUSTAINABLE YIELD (B_{MSY})..... 131

FIGURE 8.4.2.6 TORRES STRAIT TIGER PRAWN SPAWNER-RECRUITMENT RELATIONSHIP ASSUMING A) THE RICKER FORM OR B) THE BEVERTON-HOLT FORM. ONE-YEAR AUTOCORRELATIONS WERE NON-SIGNIFICANT AT -0.085 131

FIGURE 8.4.2.7 THE DELAY DIFFERENCE (LEFT), FOX SURPLUS PRODUCTION WITH CONSTRAINED LOG-LIKELIHOOD (MIDDLE), AND FOX SURPLUS PRODUCTION WITH UNCONSTRAINED LOG-LIKELIHOOD (RIGHT) MODELS CAPTURED THE TREND IN STANDARDISED CATCH-RATES QUITE WELL (1ST ROW OF PLOTS), THE USE OF LOG-NORMAL ERRORS WAS APPROPRIATE WITH NO CLEAR PATTERN IN STANDARDISED RESIDUALS (2ND ROW PLOTS), AND LINEAR NORMALITY PLOTS (3RD ROW). 133

FIGURE 8.4.2.8 THE EXPECTED BIOLOGICAL OUTCOMES FOR TORRES STRAIT TIGER PRAWNS FROM MANAGING FISHING EFFORT ACCORDING TO, (A) FISHING MORTALITY, (B) HEAVY ONE-WAY CATCH-RATE, AND (C) MODERATE ONE-WAY CATCH RATE REFERENCE POINTS. THE FIRST TWO ROWS OF PLOTS ILLUSTRATE THE OUTCOMES IN RELATION TO VIRGIN POPULATION SIZE (B_0). OUTCOMES ON THE BOTTOM TWO ROWS WERE MEASURED AGAINST THE POPULATION SIZE WHICH SUPPORTS MAXIMUM SUSTAINABLE YIELD (B_{MSY}). LOWER PROBABILITIES (OR RISKS) OF THE POPULATION SIZES FALLING BELOW $0.2B_0$ WERE FOR FISHING EFFORTS MANAGED AT 80% HEAVY ONE-WAY CATCH-RATES. SIMILAR PROBABILITIES OF THE POPULATION SIZES FALLING BELOW B_{MSY} WERE CALCULATED FOR FISHING EFFORTS MANAGED AT 3/4 AND 2/3 OF MSY EFFORT, AND 80% AND 70% MODERATE ONE-WAY CATCH-RATE REFERENCE POINTS. PROBABILITIES AT 0.5 REPRESENT THE POPULATION SIZES AT $0.2B_0$ AND B_{MSY} (EQUAL TO ONE) RESPECTIVELY. THE ONE-WAY AND TWO-WAY CATCH-RATE MANAGEMENT STRATEGIES PERFORMED ALIKE. THE RESULTS ASSUME RICKER RECRUITMENT AND MEDIAN FISHING POWER INCREASES; STATUS QUO REPRESENTS ABOUT 10 000 DAYS OF FISHING EFFORT (12 500 FISHING POWER STANDARDISED) WITH NO MANAGEMENT CHANGES..... 136

FIGURE 8.4.2.9 THE EXPECTED INDUSTRY OUTCOMES FROM FISHING TORRES STRAIT TIGER PRAWNS AND MANAGING FISHING EFFORT ACCORDING TO, (A) FISHING MORTALITY, (B) HEAVY ONE-WAY CATCH-RATE, AND (C) MODERATE ONE-WAY CATCH-RATE REFERENCE POINTS. INDUSTRY OUTCOMES WERE MEASURED AGAINST MEDIAN TOTAL CATCHES, FISHING EFFORT, CATCH-RATES AND VARIATION IN TOTAL CATCH (COEFFICIENT OF VARIATION). ALL MANAGEMENT STRATEGIES RESULTED IN SIMILAR TOTALS AND VARIATIONS IN CATCHES. HOWEVER, THE MANAGEMENT STRATEGIES OF 3/4 AND 2/3 OF MSY FISHING EFFORT, AND THE 70% AND 80% HEAVY ONE-WAY CATCH-RATE REFERENCE POINTS PRODUCED HIGHER CATCH-RATES IN THE LONG TERM. THE ONE-WAY AND TWO-WAY CATCH-RATE MANAGEMENT STRATEGIES PERFORMED ALIKE. THE RESULTS ASSUME RICKER RECRUITMENT AND MEDIAN FISHING POWER INCREASES; STATUS QUO

REPRESENTS 10 000 DAYS OF FISHING EFFORT (12 500 FISHING POWER STANDARDISED) WITH NO MANAGEMENT CHANGES.	137
FIGURE 8.4.2.10 THE AVERAGE CUMULATIVE NUMBER OF MANAGEMENT CHANGES (LIMIT CATCH-RATE TRIGGERS) FOR THE (A) HEAVY ONE-WAY CATCH-RATE, AND (B) MODERATE ONE-WAY CATCH-RATE REFERENCE POINTS. GENERALLY OVER TWENTY YEARS, BETWEEN TWO AND THREE CATCH-RATE TRIGGERS WILL OCCUR UNDER THE HEAVY ONE-WAY MANAGEMENT STRATEGY, BUT UP TO FIVE OR EIGHT MAY OCCUR UNDER MODERATE ONE-WAY MANAGEMENT STRATEGY. AGAIN, THE ONE-WAY AND TWO-WAY CATCH-RATE MANAGEMENT STRATEGIES PERFORMED ALIKE. THE RESULTS ASSUME RICKER RECRUITMENT; STATUS QUO REPRESENTS THE NUMBER OF CATCH RATES FALLING BELOW 70% CPUE FOR 10 000 DAYS OF FISHING EFFORT (12 500 STANDARDISED) WITH NO MANAGEMENT CHANGES.	137
FIGURE 8.4.2.11 DISTRIBUTION OF THE EXPLOITABLE BIOMASSES, EXPRESSED AS A RATIO OF VIRGIN BIOMASSES, AT WHICH THE CATCH-RATE REFERENCE POINTS TRIGGERED. THE RESULTS ARE SHOWN FROM THE MONTHLY DELAY DIFFERENCE MODEL FOR 10 000 TEST-FISHING DAYS OF EFFORT (12 500 STANDARDISED), ASSUMING RICKER RECRUITMENT. THE CATCH-RATE REFERENCE POINTS TRIGGERED MORE FREQUENTLY UNDER THE MODERATE ONE-WAY MANAGEMENT STRATEGY AND TRIGGER AT MARGINALLY LOWER POPULATION SIZES DUE TO THE SLOW RESPONSE OF THIS MANAGEMENT STRATEGY TO ALTER FISHING EFFORT. .	138
FIGURE 8.4.3.1 THE SAUCER SCALLOP TOTAL CATCH AND FISHING EFFORT REPORTED FROM 1989 TO THE 2002 FISHING-YEAR. THE STATISTICS REPRESENT ALL CATCHES SOUTH OF 22.5 DEGREES.	140
FIGURE 8.4.3.2 MONTHLY STANDARDISED SAUCER SCALLOP CATCH RATES FROM 1989 TO 2002; NOTE THE SEASONAL PATTERNS IN CATCH RATES AND THE OVERALL GRADUAL DECLINE. THE GAPS IN CATCH RATES RELATE TO THE OCTOBER SEASONAL CLOSURE. THE FEBRUARY 2001 CATCH RATE OF 15.5 BASKETS AND THE JANUARY 2002 CATCH RATE OF 18.6 BASKETS RELATE TO THE ROTATIONAL OPENING OF THE SPATIAL CLOSURES.	140
FIGURE 8.4.3.3 BIOLOGICAL RESEARCH ON SAUCER SCALLOPS IN 1981 SHOWED THAT (A) SPAWNING MOSTLY OCCURRED BETWEEN APRIL AND AUGUST, (B) MOST SCALLOPS OLDER THAN ABOUT EIGHT MONTHS (90 MM SHELL HEIGHT) WERE MATURE, AND (C) FECUNDITY WAS WEAKLY RELATED TO SIZE. MORE RECENTLY, DATA OBTAINED FROM FRDC PROJECT 2000/170 WERE USED TO QUANTIFY AVERAGE (D) SCALLOP TOTAL WEIGHTS, (E) SCALLOP MEAT WEIGHTS, AND (F) COMMERCIAL SIZE GRADING. 95% CONFIDENCE INTERVALS REPRESENTED BY DOTTED LINES ON FIGURES (B) TO (E); FIGURE (A) DOTTED LINES REPRESENT TWO TIMES THE 10% STANDARD ERROR. SEE TABLE 8.4.3.1 FOR DATA SOURCES.	143
FIGURE 8.4.3.4 (A) APPLICATION OF FIXED SPATIAL CLOSURES IN THE SCALLOP FISHERY COMMENCED IN 1997 AND CHANGED TO A ROTATIONAL CLOSURE STRATEGY IN 2001. (B) FISHERY INDEPENDENT SURVEYS SHOWED THAT THE NUMBER OF SCALLOPS PROTECTED BY THE CLOSURES INCREASED IN 2000, BUT DECREASED IN 2001 AND 2002. (C) FISHERY INDEPENDENT SURVEYS OF SCALLOPS ACROSS THE ENTIRE FISHERY ONLY OCCURRED BETWEEN 1997 AND 2000, WITH A PEAK ESTIMATE IN 2000. THE RAISED LINES ON (A) REPRESENT CLOSURE PERIODS. YEPPON (YA AND YB), BUSTARD HEAD (BHA, BHB, BHC AND BHD), AND HERVEY BAY (HBA, HBB, HBC AND HBD). VERTICAL LINES IN (B) AND (C) ARE 95% CONFIDENCE INTERVALS.	144
FIGURE 8.4.3.5 THE MONTHLY AGE-STRUCTURED MODEL PREDICTED DECLINING EXPLOITABLE BIOMASSES FOR SCALLOPS BETWEEN 1989 AND 1997. SINCE 1997,	

BIOMASSES VARIED AROUND THE BIOMASS REFERENCE POINT FOR MAXIMUM SUSTAINABLE YIELD (B_{MSY} THE DASHED RED HORIZONTAL LINE). RESULTS ARE PRESENTED FOR THREE ESTIMATES OF NATURAL MORTALITY (M) AND THE MODEL ASSUMED THE MEDIAN ANNUAL ESTIMATE OF INCREASING FISHING POWER. B_{MSY} WAS CALCULATED USING THE BEVERTON-HOLT SPAWNER-RECRUITMENT CURVE (FIGURE 8.4.3.8). THE DOTTED LINES REPRESENT THE 90TH PERCENTILES. 146

FIGURE 8.4.3.6 BIOMASS ESTIMATES FROM THE MONTHLY AGE-STRUCTURED MODEL FOR TWO DIFFERENT ESTIMATES OF THE ANNUAL INCREASE IN FISHING POWER. THE MODEL INCORPORATED A SINGLE ESTIMATE OF NATURAL MORTALITY ($M = 0.09$). TRENDS IN THE EXPLOITABLE BIOMASS WERE SIMILAR TO THOSE IN FIGURE 8.4.3.5A..... 146

FIGURE 8.4.3.7 THE ANNUAL SURPLUS PRODUCTION MODEL PREDICTED DECLINING EXPLOITABLE BIOMASSES FOR THE SCALLOP FISHERY BETWEEN 1989 AND 1997 FISHING YEARS (DOTTED LINES REPRESENT THE 90TH PERCENTILES). THE MODEL PREDICTED INCREASING BIOMASS SINCE 1997. THE DASHED RED HORIZONTAL LINE SHOWS THE BIOMASS REFERENCE POINT FOR MAXIMUM SUSTAINABLE YIELD (B_{MSY}). 147

FIGURE 8.4.3.8 SCALLOP SPAWNER-RECRUITMENT RELATIONSHIPS ASSUMING THE BEVERTON-HOLT FORM (RED LINE) AND THE RICKER FORM (GREEN LINE). THE CURVES WERE FITTED USING A WEIGHTED LOG-LIKELIHOOD AND INCORPORATE THE MEDIAN ESTIMATES OF ANNUAL INCREASES IN FISHING POWER. TWO-YEAR AUTOCORRELATIONS WERE NON-SIGNIFICANT AT -0.235 147

FIGURE 8.4.3.9 THE MONTHLY AGE-STRUCTURED (LEFT SIDE) AND SCHAEFER SURPLUS PRODUCTION (RIGHT SIDE) MODELS PREDICTED THE STANDARDISED CATCH-RATES WELL (1ST ROW PLOTS). THE USE OF LOGNORMAL ERRORS WAS APPROPRIATE WITH NO PATTERN IN STANDARDISED RESIDUALS (2ND ROW PLOTS) AND LINEAR NORMALITY PLOTS (3RD ROW PLOTS)..... 150

FIGURE 8.4.3.10 THE EXPECTED BIOLOGICAL OUTCOMES FOR SAUCER SCALLOPS FROM MANAGING FISHING EFFORT ACCORDING TO, (A) FISHING MORTALITY RATES, (B) HEAVY ONE-WAY CATCH-RATE, AND (C) MODERATE ONE-WAY CATCH RATE REFERENCE POINTS. THE FIRST TWO ROWS OF PLOTS ILLUSTRATE THE OUTCOMES IN RELATION TO VIRGIN POPULATION SIZE (B_0). OUTCOMES ON THE BOTTOM TWO ROWS WERE MEASURED AGAINST THE POPULATION SIZE, WHICH SUPPORTS MAXIMUM SUSTAINABLE YIELD (B_{MSY}). LOW PROBABILITIES (OR RISKS) OF THE BIOMASS FALLING BELOW $0.2B_0$ WERE OBTAINED FOR THE 60–80% CPUE REFERENCE POINTS, AND FOR THE $3/4$ MSY AND $2/3$ MSY REFERENCE POINTS. SIMILAR RESULTS WERE OBTAINED IN RELATION TO THE BIOMASS FALLING BELOW B_{MSY} WHEN EFFORT WAS MANAGED USING THE 60–80% CPUE REFERENCE POINTS. THE B_{MSY} PROBABILITIES AT 0.5 REPRESENT THE POPULATION SIZES AT B_{MSY} . THE ONE-WAY AND TWO-WAY CATCH RATE MANAGEMENT STRATEGIES PERFORMED ALIKE. THE RESULTS ASSUME BEVERTON-HOLT RECRUITMENT AND MEDIAN ESTIMATES OF THE ANNUAL INCREASE IN FISHING POWER. SIMULATIONS FOR STATUS QUO AND THE FISHING MORTALITY REFERENCE POINTS COMMENCED AT 13 000 NIGHTS OF FISHING EFFORT. SIMULATIONS FOR THE CPUE REFERENCE POINTS COMMENCED AT 10 000 NIGHTS OF FISHING..... 153

FIGURE 8.4.3.11 THE EXPECTED INDUSTRY OUTCOMES FROM FORECASTING FISHING EFFORT IN THE SCALLOP FISHERY ACCORDING TO, (A) FISHING MORTALITY, (B) HEAVY ONE-WAY CATCH-RATE, AND (C) MODERATE ONE-WAY CATCH-RATE REFERENCE POINTS. INDUSTRY OUTCOMES WERE MEASURED AGAINST TOTAL CATCHES, FISHING EFFORT, CATCH-RATES AND VARIATION IN TOTAL CATCH

(COEFFICIENT OF VARIATION). THE MANAGEMENT STRATEGIES OF 3/4 MSY AND 2/3 OF MSY FISHING EFFORT RESULTED IN EQUIVALENT LONG-TERM TOTAL CATCHES AND LOWER CATCH VARIATIONS THAN RETAINING THE STATUS QUO. HOWEVER, THE HEAVY ONE-WAY CATCH-RATE REFERENCE POINTS PRODUCED HIGHER CATCH-RATES IN THE LONG TERM. THE ONE-WAY AND TWO-WAY CATCH-RATE MANAGEMENT STRATEGIES PERFORMED ALIKE. THE FORECASTS ASSUMED BEVERTON-HOLT RECRUITMENT AND THE MEDIAN ANNUAL INCREASES IN FISHING POWER. SIMULATIONS FOR STATUS QUO AND THE FISHING MORTALITY REFERENCE POINTS STARTED AT 13 000 NIGHTS OF FISHING EFFORT. SIMULATIONS FOR THE CPUE REFERENCE POINTS COMMENCED AT 10 000 NIGHTS OF FISHING..... 154

FIGURE 8.4.3.12 THE AVERAGE CUMULATIVE NUMBER OF MANAGEMENT CHANGES (LIMIT CATCH-RATE TRIGGERS) FOR THE (A) HEAVY ONE-WAY CATCH-RATE, AND (B) MODERATE ONE-WAY CATCH-RATE REFERENCE POINTS. GENERALLY OVER TWENTY YEARS, BETWEEN THREE AND SIX CATCH-RATE TRIGGERS WILL OCCUR UNDER THE HEAVY ONE-WAY MANAGEMENT STRATEGY, BUT UP TO SIX OR EIGHT MAY OCCUR UNDER THE MODERATE ONE-WAY MANAGEMENT STRATEGY. AGAIN, THE ONE-WAY AND TWO-WAY CATCH-RATE MANAGEMENT STRATEGIES PERFORMED ALIKE. THE RESULTS ASSUME BEVERTON-HOLT RECRUITMENT AND MEDIAN FISHING POWER INCREASES. SIMULATIONS FOR STATUS QUO COMMENCED AT 13 000 NIGHTS OF FISHING EFFORT AND REPRESENTS THE NUMBER OF CATCH RATES FALLING BELOW 70% CPUE. SIMULATIONS FOR THE CPUE REFERENCE POINTS COMMENCED AT 10 000 NIGHTS OF FISHING..... 155

FIGURE 8.4.3.13 DISTRIBUTION OF THE EXPLOITABLE BIOMASSES, EXPRESSED AS A RATIO OF VIRGIN BIOMASSES, AT WHICH THE CATCH-RATE REFERENCE POINTS TRIGGERED. THE RESULTS ARE SHOWN FROM THE MONTHLY AGE-STRUCTURED MODEL FOR 15 000 TEST-FISHING DAYS OF EFFORT, ASSUMING BEVERTON-HOLT RECRUITMENT. THE CATCH-RATE REFERENCE POINTS TRIGGERED MORE FREQUENTLY UNDER THE MODERATE ONE-WAY MANAGEMENT STRATEGY AND TRIGGER AT MARGINALLY LOWER POPULATION SIZES DUE TO THE SLOW RESPONSE OF THIS MANAGEMENT STRATEGY TO CHANGE FISHING EFFORT..... 156

FIGURE 15.2.1 STANDARDISED RESIDUALS FOR DEEP WATER EASTERN KING PRAWNS. 241

FIGURE 15.2.2 STANDARDISED RESIDUALS FOR SHALLOW WATER EASTERN KING PRAWNS. 241

FIGURE 15.2.3 STANDARDISED RESIDUALS FOR NORTH QUEENSLAND TIGER PRAWNS. 242

FIGURE 15.2.4 STANDARDISED RESIDUALS FOR SAUCER SCALLOPS. 242

FIGURE 15.2.5 STANDARDISED RESIDUALS FOR TORRES STRAIT TIGER PRAWNS. 243

Tables

TABLE 5.3.1 BREAKDOWN OF THE NUMBER OF OWNERS AND SKIPPERS OPERATING IN THE MAJOR QUEENSLAND EAST COAST AND TORRES STRAIT TRAWL SECTORS IN EACH YEAR THAT WERE INTERVIEWED AS PART OF THE QUESTIONNAIRE.	11
TABLE 6.4.1 PARAMETER ESTIMATES (β_2 AND β_3) AND STANDARD ERRORS IN PARENTHESIS FROM THE GENERAL LINEAR MODEL ANALYSIS (NATURAL LOG TRANSFORMED), FOR EACH TRAWL SECTOR 1989 TO 1999. THE BOLD PARAMETERS INDICATE THE MOST IMPORTANT COVARIATE EFFECTS ON FISHING POWER. NS INDICATES THE PARAMETER WAS NOT SIGNIFICANT AND EXCLUDED FROM THE ANALYSIS ($P > 0.05$). * INDICATES THE GEAR TYPE WAS GROUPED UNDER OTHER LESS USED TYPES.	43
TABLE 6.4.2 PARAMETER ESTIMATES (β_2 AND β_3) AND STANDARD ERRORS IN PARENTHESIS FROM THE GENERAL LINEAR MODEL ANALYSIS (NATURAL LOG TRANSFORMED), FOR THE TORRES STRAIT TIGER PRAWN SECTOR 1982 TO 2000 (UPDATED ANALYSIS). THE BOLD PARAMETERS INDICATE THE MOST IMPORTANT COVARIATE EFFECTS ON FISHING POWER. ADDITIONAL PARAMETERS NOT REPORTED WERE EITHER NON-SIGNIFICANT ($P > 0.05$) OR CORRELATED WITH THOSE ALREADY IN THE MODEL BELOW.	44
TABLE 6.4.3 GENERAL LINEAR MODEL β_3 PARAMETER CORRELATIONS BETWEEN THE DIFFERENT VESSEL CHARACTERISTICS, FOR EACH TRAWL SECTOR. CORRELATIONS LARGER THAN 0.3 ARE LISTED.	45
TABLE 6.4.4 PERCENT CHANGE IN AVERAGE FISHING POWER FROM 1989 TO 1999 (95% CONFIDENCE INTERVALS SHOWN IN PARENTHESES), FOR THE SHALLOW WATER (< 50 FM DEPTH) EASTERN KING PRAWN, THE DEEP WATER (> 50 FM DEPTH) EASTERN KING PRAWN, THE NORTH QUEENSLAND TIGER PRAWN AND THE SAUCER SCALLOP TRAWL SECTORS. NOTE THE PERCENT CHANGE REPRESENTS THE DIFFERENCE FROM THE BASE REFERENCE YEAR 1989, WHICH WAS SET AT 0. THE SIGNIFICANCE OF CHANGES IN FISHING POWER SHOULD BE COMPARED BETWEEN ALL YEARS, NOT JUST 1989. THE FISHING YEARS REPRESENT THE PERIOD FROM NOVEMBER THROUGH TO OCTOBER FOR THE EASTERN KING PRAWN AND SAUCER SCALLOP SECTORS, AND MARCH THROUGH TO FEBRUARY FOR THE TIGER PRAWN SECTORS.	46
TABLE 6.4.5 PERCENT CHANGE IN AVERAGE FISHING POWER FROM 1980 TO 2002 (95% CONFIDENCE INTERVALS SHOWN IN PARENTHESES), FOR THE TORRES STRAIT TIGER PRAWN TRAWL SECTOR (USING 1982 TO 2000 GLM ANALYSIS). NOTE THE PERCENT CHANGE REPRESENTS THE DIFFERENCE FROM THE BASE REFERENCE YEAR 1980, WHICH WAS SET AT 0. THE SIGNIFICANCE OF CHANGES IN FISHING POWER SHOULD BE COMPARED BETWEEN ALL YEARS, NOT JUST 1989. THE FISHING YEARS REPRESENT MARCH THROUGH TO FEBRUARY FOR THIS TIGER PRAWN SECTOR. THESE ESTIMATES ARE PLOTTED USING RED LINES IN FIGURE 6.4.3	47
TABLE 7.3.1 QFISH GRIDS ASSOCIATED WITH EACH FISHERY	57
TABLE 8.3.2.1 THE WEIGHTINGS USED TO CALCULATE AVERAGE FISHING POWER INCREASES FOR QUEENSLAND AND NEW SOUTH WALES. WEIGHTINGS FOR SHALLOW WATERS WERE BASED ON SUMMING FISHING EFFORT ACROSS NEW SOUTH WALES, THE QUEENSLAND LOGBOOK GRIDS CLASSIFIED AS HAVING WATER DEPTHS LESS THAN 50 FATHOMS AND HALF OF THE QUEENSLAND FISHING EFFORT THAT COULD NOT BE CLEARLY CLASSIFIED AS EITHER DEEP OR SHALLOW WATERS. THE DEEP WATER WEIGHTING WERE DERIVED BY SUMMING FISHING EFFORT ACROSS THE QUEENSLAND LOGBOOK GRIDS CLASSIFIED AS HAVING WATER DEPTHS	

GREATER THAN 50 FATHOMS AND HALF OF THE QUEENSLAND FISHING EFFORT THAT COULD NOT BE CLEARLY CLASSIFIED AS EITHER DEEP OR SHALLOW WATERS.	83
TABLE 8.3.3.1 THE EQUATIONS DEFINING THE DELAY-DIFFERENCE MODELLING FOR EASTERN KING AND TIGER PRAWNS.	86
TABLE 8.3.6.1 ALGORITHM USED TO GENERATE 90% CONFIDENCE INTERVALS FOR THE DELAY DIFFERENCE AND AGE STRUCTURED MODEL OUTPUTS.	94
TABLE 8.3.7.1 HISTORICAL TRAWL DATA SOURCES AND DESCRIPTION.	95
TABLE 8.3.8.1 SPAWNER-RECRUITMENT (S/R) AND STEEPNESS EQUATIONS.	99
TABLE 8.3.10.1 THE CATCH RATE AND FISHING MORTALITY REFERENCE POINTS EXAMINED THROUGH SIMULATION. THEIR LINK TO FISHERIES MANAGEMENT IS DEFINED UNDER THE MANAGEMENT STRATEGY EVALUATION (MSE) BELOW. $CPUE_T$ WERE THE AVERAGE CATCH RATES IN THE CURRENT REVIEW PERIODS DESCRIBED IN THE QUEENSLAND EAST COAST TRAWL MANAGEMENT PLAN (QECTMP); $60\%CPUE$, $70\%CPUE$, AND $80\%CPUE$ WERE THE PERCENTAGE OF THE AVERAGE CATCH RATES FROM THE REFERENCE REVIEW PERIODS BETWEEN 1988 AND 1997 (QECTMP 2001).	103
TABLE 8.3.10.2 ALGORITHM TO SIMULATE REFERENCE POINTS.	104
TABLE 8.3.10.3 DETAILS OF THE UNCERTAINTIES ALLOWED FOR IN THE EASTERN KING AND TIGER PRAWN DELAY DIFFERENCE OPERATING MODELS. THE ITALIC SYNTAX REPRESENTS MATLAB FUNCTIONS. GRAPHICAL DISPLAY OF THE ERROR DISTRIBUTIONS AND THEIR JUSTIFICATIONS ARE PRESENTED IN THE RESULTS SECTION.	108
TABLE 8.3.10.4 DETAILS OF THE UNCERTAINTIES ALLOWED FOR IN THE SAUCER SCALLOP AGE-STRUCTURED OPERATING MODEL. THE ITALIC SYNTAX REPRESENTS MATLAB FUNCTIONS. GRAPHICAL DISPLAY OF THE ERROR DISTRIBUTIONS AND THEIR JUSTIFICATIONS ARE PRESENTED IN THE RESULTS SECTION.	109
TABLE 8.4.1.1 EASTERN KING PRAWN BIOLOGICAL PARAMETERS USED AS FIXED INPUTS INTO THE MONTHLY DELAY DIFFERENCE MODEL.	113
TABLE 8.4.1.2 EASTERN KING PRAWN SPAWNER-RECRUITMENT PARAMETERS AND THE DELAY-DIFFERENCE EQUILIBRIUM MANAGEMENT QUANTITIES FOR THE BASE CASE BIOLOGICAL PARAMETERS AND THREE LEVELS OF FISHING POWER. NUMBERS WITHIN BRACKETS REFER TO THE STANDARD ERROR AND T STATISTIC FOR THE SPAWNER-RECRUITMENT PARAMETERS AND 90% CONFIDENCE INTERVALS FOR THE MANAGEMENT PARAMETERS.	118
TABLE 8.4.1.3 SUMMARY OF THE PARAMETERS ESTIMATED FROM THE SURPLUS PRODUCTION MODEL.	118
TABLE 8.4.1.4 ADDITIONAL DELAY-DIFFERENCE SENSITIVITIES BASED ON VARYING THE PRAWN GROWTH PARAMETER (ρ) AND NATURAL MORTALITY (M).	118
TABLE 8.4.1.5 THE NUMBER OF DAILY CATCH RECORDS AND WEIGHTINGS USED TO CONSTRUCT THE SPAWNER-RECRUITMENT CURVES; APPROXIMATELY 12% OF DATA WERE FROM 1970 TO 1987, THE YEARS 1981 TO 1983 WERE EXCLUDED GIVEN THE EXTREME PAUCITY OF DATA. THE WEIGHTINGS WERE CALCULATED USING TOTAL RECORDS (RECRUITMENT + SPAWNING)	119
TABLE 8.4.1.6 THE ACCURACY OF CATCH-RATE REFERENCE POINTS FOR 45 000 TEST-FISHING DAYS OF EFFORT, ASSUMING BEVERTON-HOLT RECRUITMENT. THE HIGHER PROBABILITIES FOR THE 80% CPUE AND MODERATE ONE-WAY MANAGEMENT STRATEGY INDICATE BETTER ACCURACY MEASURED AGAINST THE BIOMASS REFERENCE LEVELS OF $0.2B_0$ AND B_{MSY}	125

TABLE 8.4.2.1 TORRES STRAIT TIGER PRAWN PARAMETERS USED AS BIOLOGICAL INPUTS INTO THE MONTHLY DELAY DIFFERENCE MODEL.	128
TABLE 8.4.2.2 TORRES STRAIT TIGER PRAWN SPAWNER-RECRUITMENT PARAMETERS AND THE DELAY DIFFERENCE EQUILIBRIUM MANAGEMENT QUANTITIES. NUMBERS WITHIN THE PARENTHESES REFER TO THE STANDARD ERROR AND T STATISTIC FOR THE SPAWNER-RECRUITMENT PARAMETERS AND 90% CONFIDENCE INTERVALS FOR THE STEEPNESS AND MANAGEMENT PARAMETERS.....	132
TABLE 8.4.2.3 ADDITIONAL DELAY-DIFFERENCE SENSITIVITIES BASED ON VARYING THE PRAWN GROWTH PARAMETER (ρ), NATURAL MORTALITY (M), AND FISHING POWER INCREASES.	132
TABLE 8.4.2.4 SUMMARY OF EQUILIBRIUM MANAGEMENT PARAMETERS ESTIMATED FROM THE SURPLUS PRODUCTION MODELS.	132
TABLE 8.4.2.5 ADDITIONAL SURPLUS PRODUCTION EQUILIBRIUM MANAGEMENT ESTIMATES USING ALL DATA.	132
TABLE 8.4.2.6 THE ACCURACY OF CATCH-RATE REFERENCE POINTS MEASURED FROM THE MONTHLY DELAY DIFFERENCE FOR 10 000 TEST-FISHING DAYS OF EFFORT (12 500 STANDARDISED), ASSUMING RICKER RECRUITMENT. THE HIGHER PROBABILITIES FOR THE 80% CPUE AND MODERATE ONE-WAY MANAGEMENT STRATEGY INDICATE BETTER ACCURACY MEASURED AGAINST THE BIOMASS REFERENCE LEVELS OF $0.2B_0$ AND B_{MSY} (E.G. 0.94 IS 94% ACCURATE).....	139
TABLE 8.4.3.1 SAUCER SCALLOP PARAMETERS USED AS BIOLOGICAL INPUTS INTO THE MONTHLY AGE-STRUCTURED MODEL; STANDARD ERRORS IN PARENTHESES.	142
TABLE 8.4.3.2 SAUCER SCALLOP SPAWNER-RECRUITMENT PARAMETERS. NUMBERS WITHIN PARENTHESES REFER TO THE PARAMETER STANDARD ERROR AND T STATISTIC FOR α AND β , AND 90% CONFIDENCE INTERVALS FOR STEEPNESS.	148
TABLE 8.4.3.3 THE NUMBER OF DAILY CATCH RECORDS AND WEIGHTINGS USED TO CONSTRUCT THE SPAWNER-RECRUITMENT CURVES. THE VAST MAJORITY OF DATA (95%) WERE OBTAINED FROM THE COMPULSORY LOGBOOK PROGRAM THAT COMMENCED IN 1988.	148
TABLE 8.4.3.4 SCALLOP EQUILIBRIUM MANAGEMENT QUANTITIES AS CALCULATED FROM THE MONTHLY AGE-STRUCTURED MODEL USING TWO FORMS OF THE SPAWNER-RECRUITMENT RELATIONSHIP AND MEDIAN ANNUAL INCREASES IN FISHING POWER. THE QUANTITIES WERE CALCULATED FOR FOUR DIFFERENT MINIMUM LEGAL SHELL-SIZES. *NOTE COMMENT IN PARAGRAPH TWO UNDER THE BIOLOGICAL DATA AND MANAGEMENT SECTION. NUMBERS IN PARENTHESIS ARE 90% CONFIDENCE INTERVALS.	149
TABLE 8.4.3.5 ADDITIONAL MANAGEMENT CALCULATIONS, FROM THE SCALLOP AGE-STRUCTURED MODEL, BASED ON VARYING THE MONTHLY RATE OF NATURAL MORTALITY (M) AND FISHING POWER INCREASES. THESE RESULTS RELATE TO THE CURRENT MINIMUM LEGAL SIZE OF 90 MM JAN–APR, AND 95 MM MAY–DEC, ASSUMING BEVERTON-HOLT RECRUITMENT.	149
TABLE 8.4.3.6 SUMMARY OF THE PARAMETERS ESTIMATED FROM THE SCHAEFER SURPLUS PRODUCTION MODEL.	150
TABLE 8.4.3.7 THE ACCURACY OF SIX CATCH-RATE REFERENCE POINTS MEASURED FROM THE MONTHLY AGE-STRUCTURED MODEL FOR 15 000 TEST-FISHING DAYS OF EFFORT. THE HIGHER PROBABILITIES FOR THE 80% CPUE AND MODERATE ONE-WAY MANAGEMENT STRATEGY INDICATE BETTER ACCURACY MEASURED AGAINST THE BIOMASS REFERENCE LEVELS OF $0.2B_0$ AND B_{MSY}	157
TABLE 9.1 THE LIST OF MEETINGS WHERE PROJECT RESULTS WERE PRESENTED.	174

1999/120	Reference point management and the role of catch-per-unit effort in prawn and scallop fisheries
-----------------	--

PRINCIPAL INVESTIGATORS Tony Courtney and Michael O'Neill
ADDRESS Queensland Department of Primary Industries and Fisheries
Southern Fisheries Centre
PO Box 76
Deception Bay, Queensland 4508
Telephone (07) 3817 9582
Facsimile (07) 3817 9555

CO-INVESTIGATOR Clive Turnbull
ADDRESS Queensland Department of Primary Industries and Fisheries
Northern Fisheries Centre
PO Box 5396
Port Smith, Queensland 4870
Telephone (07) 4035 0107
Facsimile (07) 4035 1401

OBJECTIVES

1. Produce an in-depth description of the gear and technological improvements of a representative sample for the a) Torres Strait tiger prawn, b) Queensland eastern king prawn and c) south-east Queensland saucer scallop fisheries, for the period 1970 to present.
2. Establish a standardised catch-per-unit effort series of the above fisheries.
3. Compare present Management Plan reference points with the standardised and unstandardised catch-per-unit effort series.
4. Investigate and establish robust reference points and response mechanisms through simulation modelling.
5. Disseminate results to TrawlMAC, the QFMA (since changed to Queensland Fisheries Service, QFS) trawl fishery managers and fishers.

OUTCOMES ACHIEVED TO DATE

The project has:

- described and quantified the uptake of technical improvements in fishing gear in the Queensland and Torres Strait prawn trawl fleets over the last 40 years (1960–2000).
- quantified average annual increases in fishing power in these sectors, standardised their catch rates, and developed stock assessment models that consider the annual increases in fishing power and stock-recruitment relationships.
- applied the models to assess the Management Plan's reference points and put forward alternatives that the Queensland Fisheries Service (QFS) and Australian Fisheries Management Authority (AFMA) are actively considering to manage the stocks and reduce the likelihood of overfishing.

1 NON-TECHNICAL SUMMARY

In the first stage of the project (Objective 1), 344 past and present vessel owner/operators were interviewed and completed a questionnaire quantifying the adoption rates of technologies affecting fishing power in the major Queensland fishing sectors (the eastern king prawn, scallop, north Queensland tiger/endeavour prawn) and Torres Strait tiger/endeavour prawn fisheries. The Torres Strait fleet adopted technologies at a faster rate compared with the east coast sectors. For all sectors, there were increases in average vessel size, engine horsepower, gearbox ratios, trawl speed, fuel capacity and consumption, and propeller size, pitch and adoption of propeller nozzles. Trawl speeds were highest in the tiger prawn sectors and lowest in the scallop fishery. Try gear was adopted by all sectors from the late 1970s but appears to have limited application when used in the deep water (> 50 fm) eastern king prawn sector. The towing configuration of nets has also experienced profound change characterised by a shift from single or twin gear in the 1960s and 1970s, to triple gear and quad gear presently used. The average size of the nets (i.e. head rope length) increased in the early years of the fishery but has plateaued to slightly under the maximum allowable, partly as a result of regulation. Drop chains are the most widely used ground chain type in all sectors. Flat otter boards were the most commonly used board type, but their use has declined over the last 20 years, particularly in the tiger/endeavour prawn sectors where they are being replaced with kilfoil, louvre or bison type boards. Autopilot, colour echo sounders, radar and global positioning systems are now fully adopted (100% of vessels) in each sector. Computer mapping systems continue to be adopted in the east coast sectors but were fully adopted (100% of vessels) in Torres Strait by 2000. Telecommunications have undergone marked improvements, particularly with the uptake of mobile and satellite phones, and to a lesser degree, facsimile and email. Adoption of HF, VHF and UHF radios have increased while 27 MhZ radio usage has declined. The spatial pattern in uptake of certain technologies suggests they were first adopted in the northern tiger/endeavour prawn sectors, probably from dual endorsed (Queensland east coast/Torres Strait/Northern Prawn Fishery) vessels and then progressively adopted over time in the southern scallop and eastern king prawn sectors.

In the second stage (Objective 2), annual changes in average relative fishing power for each sector were calculated as a function of the fishing gear technology parameters estimated in a general linear model and the proportional usage of each technology. The shallow water eastern king prawn sector had the highest increase in average annual fishing power of 27% between 1989 and 1999, while the Torres Strait had the second highest increase of 24% between 1982 and 2002. The north Queensland tiger/endeavour prawn sector had the next highest increase in average fishing power of 6% between 1989 and 1999, followed by the deep water eastern king prawn sector with an increase of 5% over the same period. The scallop sector had the lowest average annual increase in fishing power of only 3% between 1989 and 1999. The third stage of the project applied the average annual increases in fishing power to logbook catch rate data to determine the likelihood of nominal and standardised catch rates falling below the catch rate reference points as defined in the Queensland Trawl Fishery Management Plan (Objective 3). This exercise was limited to the eastern king prawn, scallop and north Queensland tiger prawn sectors as management of the Torres Strait fishery is outside the Plan's jurisdiction. The Plan's catch rate reference points are defined as 70% of the average catch rates for each stock for the period 1988 to

1997. Due to ambiguities in the spatial and temporal definition of the Plan's reference points, seasonal and monthly comparisons of catch rates were made, as well as for two spatial resolutions. Reference points were triggered for the 1998 and 2000 fishing year for scallops when catch rates were calculated by season and all grids combined, but only the 1998 fishing year was triggered if only scallop grids were used. Similar patterns arose when using monthly data. No review events were triggered for the eastern king prawn or north Queensland tiger prawns using seasonal catch rates. However, a review event was triggered when monthly catch rates were used in the eastern king prawn shallow sector using all grids for two out of four months for the 2000 fishing year. One month triggered a review event in the 2000 fishing year for north Queensland tiger prawn. The work has highlighted the need to a) better define the catch rate reference points as they are currently stated in the Management Plan, b) determine an acceptable risk of catch rates falling below a reference point, and c) instigate a formal process of comparing standardised catch rates and reference points annually, and employ appropriate management strategies when a review event is triggered.

The final stage of the project developed stock assessment models that incorporated stock-recruitment relationships and the annual increases in fishing power to evaluate the Plan's 70% catch rate reference point, as well as alternatives (Objective 4). The models tested management responses to the triggered reference points of 60%, 70%, and 80% of the average catch rate. Three model-based reference points targeting fishing effort at maximum sustainable yield (E_{MSY}), $3/4E_{MSY}$ and $2/3E_{MSY}$ were also examined. The catch rate reference points resulted in sustainable levels of fishing, but can trigger at high population sizes and cause inappropriate changes in fishing effort. Similarly, catch rates for low population sizes may not necessarily fall below the catch rate trigger. In general, we found that the reference points targeting fishing effort to $2/3E_{MSY}$ or $3/4E_{MSY}$ maintained populations slightly above the size that supports maximum sustainable yield. These reference points resulted in lower risks of under or overfishing, improved catches and higher catch rates. The stock assessments suggest all three stocks (eastern king prawn, Torres Strait tiger prawn, and saucer scallop) were fished to the limit of maximum sustainable yields, but eastern king prawn population sizes prior to 2001 may have been lower than this. All results were sensitive to the uncertainty on the spawner-recruitment relationships, the estimates of annual increases in fishing power, the accuracy of the logbook catch data. New types of data are essential to improve the stock assessments, such as spatial indices of abundance collected through fishery independent sampling and vessel monitoring systems (VMS). More accurate and robust reference points may exist using these data, rather than model based reference points. These pieces of information, together with annually updated information on trawl vessel fishing gear and technological changes, will aid in refining further stock assessments, defining more accurate reference points and strengthening future management decisions.

The results have been presented (Objective 5) through several meetings of a) the Torres Strait Working Group and included the Torres Strait Prawn Entitlement Holders Association (TSPEHA) and both state (QFS) and federal (AFMA) fishery managers, b) the Queensland TrawlMAC and scientific advisory group (SAG), c) special management meetings with scallop fishers, processors and QFS trawl managers, d) a Mooloolaba branch meeting of the Queensland Seafood Industry Association (QSIA) whose members principally target eastern king prawns, and e) the

Project's Steering Committee which comprised industry representatives, the fishery managers and project staff. Aspects of the study were also presented by M. O'Neill at the a) Life Histories, Assessment and Management of Crustacean Fisheries Conference organised by EDFAM in A Coruna, Spain, October 2001 and b) the Australian Genstat Conference (GENSTAT 2001) in Surfers Paradise, Queensland, Australia January 2001. The stock assessment of the Torres Strait prawn fishery was independently reviewed by Dr. David Die (University of Miami, USA) in October 2003, as contracted by the AFMA (Report of the review available through AFMA).

KEYWORDS: Fishing power, effort creep, standardised catch rates, prawns, scallops, otter trawling, regression analysis, stock assessment, reference points.

2 BACKGROUND

Trawl fisheries for prawns and scallops are the most valuable commercial fishery resources in Queensland and Torres Strait. In both areas the fisheries are complex in that they target several species and are multi-endorsed. The Queensland East Coast Trawl Fishery, in particular, is highly diverse, with a range of species being taken in clearly defined areas and times along the 2500 km length of coastline.

In Torres Strait, brown tiger prawns (*Penaeus esculentus*) are targeted for export markets and comprise about 40% of the catch. The remaining catch consists mainly of blue endeavour prawns (*Metapenaeus endeavouri*) and the red spot king prawn (*Penaeus longistylus*). The total catch from this fishery is of the order of 1500 to 2000 tonnes annually, with a landed value in excess of \$20 million.

In the Queensland East Coast Trawl Fishery, recognisable fisheries for eastern king prawns (*Penaeus plebejus*) and saucer scallops (*Amusium balloti*) are by far the most valuable components of the fishery in the southern half of the state. Total landings of these two species generate wharfside-landing values of some \$50 million annually — more than one third of the Queensland East Coast Trawl Fishery's total value.

The Queensland Fisheries Service (formally the Queensland Fisheries Management Authority) and the Australian Fisheries Management Authority jointly manage the Torres Strait prawn trawl fishery, using a range of input controls (limited entry, boat-nights allocation, gear size, spatial and seasonal closures). A Total Allowable Catch was used initially but has been removed. Before the ratification of the Torres Strait treaty in 1985, the fishery was managed as part of the East Coast Trawl Fishery. Therefore, many of the present regulations are common to, and reflect, those of the east coast. The Queensland East Coast Trawl Fishery is managed under a single entity by the Queensland Fisheries Service using input controls that include licence limitation, gear and hull specifications, and seasonal and spatial closures. Despite these restrictions, stocks on the east coast, in particular, are subject to heavy effort levels that may not be sustainable in the long term.

At present, the process by which sustainability and overfishing are identified in these fisheries is ambiguous. Formal management plans are being developed for all Queensland fisheries at this time. These plans, when accepted by industry and government, will be gazetted as subsidiary legislation. All plans are required to meet the objectives of the *Queensland Fisheries Act 1994*, which include requirements that fisheries resources are used in an ecologically sustainable manner. The draft management arrangements proposed for the Queensland East Coast Trawl Fishery include the reliance upon a series of limit reference points, as an index of stock abundance. These reference points have been derived from ad hoc methods and unstandardised catch and effort data.

Limit reference points, especially, are important in that they determine the stage at which a resource is declared to be in some danger of overexploitation. There are, however, clear indications that the effective fishing effort is increasing through improved navigational equipment, crew experience, gear design, establishment of new areas and innovative electronic developments. If catch-per-unit effort data are to be used for assessing the fishery and the basis of the decision rules that affect the fishery,

it is essential that these data are adjusted to compensate for the effect of increasing fishing power impacting on the stocks.

If triggered, the limit reference points introduce decision rules that appreciably reduce fishing effort. There has been virtually no research into the validity of the Queensland East Coast Trawl Fishery trigger points in terms of their relationship to resource sustainability, or into the effectiveness of related decision rules in rebuilding stocks. Trigger points and decision rules have not yet been developed for the Torres Strait fishery.

Simulation models have been utilised internationally to investigate and develop appropriate reference points that can be applied to the particular resources and fishery's needs. These models can supply precise mathematical definitions for several reference points and test which of these points are appropriate for the resource and management system. They can also be used to investigate and evaluate a range of harvest strategies (input and output control systems) for management. This project will facilitate the selection and validation of reference points that are much more robust than those currently proposed in the Queensland Trawl Fishery Management Plan.

3 NEED

Fishery Management Plans are currently being developed for all major fisheries in Queensland. In the next few years, these plans will become the legal framework within which management practices are applied. Limit and target reference points have been developed and put forward as key assessment and management tools in all of these plans. Methods used to estimate the reference points have generally been ad hoc and based on un-standardised catch and effort data.

Clearly, there is a strong need to test these reference points.

In the Queensland East Coast Trawl Fishery Management Plan the limit reference points are based on a comparison of the average catch-per-unit-effort from 1988–96 with the relevant year's catch-per-unit effort. At present, this comparison of CPUEs takes no account of changes in effective effort.

However, effective fishing effort continually increases, even though the number of licence holders and total number of days fished each year remains constant. This continual 'effort creep' is characteristic of trawl fleets and is due to fishers adopting technological improvements in fishing practices, such as GPS and plotters. A recent study of the northern prawn fishery indicates that when GPS and plotters are used concurrently, relative fishing power increases by 7% over boats without such equipment (Robins et al. 1998).

We propose to standardise the effort of the trawl fleet, which is capital intensive and would therefore be most affected by technological advances. Two major trawl fleets operate within the Queensland region; the Torres Strait and the Queensland East Coast Trawl licensed trawl fleets. In terms of value, the most important species captured by these vessels are tiger prawns, eastern king prawns and saucer scallops. AFMA and the Torres Strait Scientific Advisory Committee need a detailed analysis and assessment of the Torres Strait tiger prawn fishery. The Prawn Working Group for Torres Strait has discussed the issue of possible changes in effective effort and the managers are of the opinion that this issue needs to be investigated. The small size of the fleet will simplify analysis compared with analysing the full Queensland tiger prawn fishery.

In summary, effective reference points must be clearly defined and relate to a management system that uses a catch-per-unit-effort series for changes in fishing power.

References

- Robins C.J., Wang, Y-G, Die, D. (1998) The impact of global positioning systems and plotters on fishing power in the northern prawn fishery, Australia. *Canadian Journal of Fisheries & Aquatic Sciences* **55**, 1645–1651.

4 OBJECTIVES

1. Produce an in-depth description of the gear and technological improvements of a representative sample for the a) Torres Strait tiger prawn, b) Queensland eastern king prawn and c) south-east Queensland saucer scallop fisheries for the period 1970 to present.
2. Establish a standardised catch-per-unit-effort series of the above fisheries.
3. Compare present Management Plan reference points with the standardised and unstandardised catch-per-unit effort series.
4. Investigate and establish robust reference points and response mechanisms through simulation modelling.
5. Disseminate results to TrawlMAC, the QFMA (since changed to Queensland Fisheries Service, QFS) trawl fishery managers and fishers.

There was discussion during the first steering committee meeting (13/9/1999) of including the north Queensland tiger prawn fishery in the project. It was pointed out that this fishery should have high priority because of its value and location in the Great Barrier Reef Marine Park. The committee agreed that the project should include the tiger prawn fishery as additional work in Objectives 1 to 3, but not included in Objective 4 as it would require significant additional funding to model the complexities of this sector.

5 OBJECTIVE 1. PRODUCE AN IN-DEPTH DESCRIPTION OF THE GEAR AND TECHNOLOGICAL IMPROVEMENTS OF A REPRESENTATIVE SAMPLE FOR THE A) TORRES STRAIT TIGER PRAWN, B) QUEENSLAND EASTERN KING PRAWN AND C) SOUTH-EAST QUEENSLAND SAUCER SCALLOP FISHERIES FOR THE PERIOD 1970 TO PRESENT.

5.1 ABSTRACT

This chapter describes the technologies affecting fishing power, and quantifies their rates of adoption in the major sectors of the Queensland east coast trawl fishery and Torres Strait for the period 1960–2000, inclusive. The technologies are broadly broken down into changes in (i) general vessel characteristics, (ii) trawl gear, including nets, ground chains and otter boards, (iii) navigation and (iv) communication. The results were based on the responses from 344 past and present vessel owner/operators to a detailed questionnaire and confirm that marked technical changes have been adopted in all of the major trawl fishing sectors. The Torres Strait fleet which targets tiger and endeavour prawns is technically more advanced, and has adopted technologies at a faster rate compared with the north Queensland tiger/endeavour prawn sector, the scallop sector and the eastern king prawn sector. For all sectors, there were increases in most of the general vessel characteristics, including average vessel size, engine horsepower, gearbox ratios, trawl speed, fuel capacity and consumption, and propeller size, pitch and adoption of propeller nozzles. Although trawl speed has increased in each sector, the results highlight differences between sectors, notably that trawl speed is higher for the tiger prawn sectors and lower for the scallop fishery. Try gear was adopted by all sectors from the late 1970s and early 1980s, but it appears to have limited practical application in the deep water (> 50 fm) eastern king prawn fishery. The configuration of the nets towed in each sector has also experienced profound change characterised by a shift from towing single or twin gear in the 1960s and 1970s, to the triple gear and quad gear presently used. The average size of the nets (i.e. head rope length) increased in the early years of the fishery but has plateaued to slightly under the maximum allowable in depths less than 50 fm. In greater depths (> 50 fm) the average head rope length is well under the maximum allowable, most likely because of the restrictions on vessel size. Drop chains are the most widely used ground chain type across all sectors. Similarly, flat otter boards have been, by far, the most commonly used board type in each sector, but their use has declined over the last 20 years particularly in the tiger/endeavour prawn sectors, where they are being replaced with Kilfoil, louvre or bison type boards. Autopilot, colour echo sounders, radar and global positioning systems are now fully adopted (100% of vessels) in each sector. Computer mapping systems began to be adopted in the late 1980s and while their uptake continues for the east coast sectors, they were fully adopted (100% of vessels) in Torres Strait fleet by 2000. Methods of communication have undergone marked improvements over the last 20 years, particularly with the uptake of mobile and satellite phones, and to a lesser degree, facsimile and email. Adoption of HF, VHF and UHF radios have increased while 27 MhZ radio usage has declined. For some technologies, particularly modifications to fishing gear and navigation, the spatial pattern in uptake suggests they were first adopted in the northern tiger/endeavour

prawn sectors, possibly from dual endorsed (Queensland east coast/Torres Strait/Northern Prawn Fishery) vessels and then progressively adopted over time in the southern scallop and eastern king prawn sectors.

5.2 INTRODUCTION

The number of licensed otter trawlers in the Queensland east coast trawl fishery (QECTF) peaked at 1413 in 1980 Bowen and Hancock 1985 and has declined since to 506 (T1 and T2 otter board endorsements at the time of writing 13/3/2003, source Queensland Fisheries Service). The main contributing factors for the decline during the 1980s and 1990s were attributed to the 1979 ‘freeze’ on issuing new licenses and the two-for-one boat replacement policy. More recently, as a result of the Trawl Fishery Management Plan introduced in 1999, the introduction of transferable fishing rights to individual operators has led to a significant reduction in the number of licence holders. The Plan also abandoned the two-for-one boat replacement policy for an alternative based on effort units and a quantitative fishing power-vessel hull unit size relationship.

A detailed temporal and spatial database on catch and fishing effort in the QECTF has been maintained through a mandatory logbook since 1988 and, as a result, fishing effort has been monitored and is now capped. However, there has been no comprehensive attempt to quantify the rate at which new technologies have been adopted by fishers, or the effect they have had on fishing power. It is widely agreed that one boat-day of fishing effort in the 1970s is less effective than one boat-day in the 2000s, but it is unknown precisely what changes have been adopted or how much they have affected fishing power.

Thus, while the number of licence holders in the fishery has declined, the influence of technological improvements on fishing power has not been assessed. Examples of these technologies include: increased engine power, global positioning systems (GPS) and differential GPS, computer-based mapping and navigational systems, and changes to fishing gear, such as try gear and the mandatory introduction of bycatch reduction devices (both BRDs and turtle excluder devices TEDs).

Catch-per-unit effort (CPUE) data need to be adjusted or standardised to take account of the influence of these changes on fishing power. Prior to the current research initiative, only nominal (unstandardised) CPUE data were examined from the QECTF. Although annual increases in fishing power may be small (i.e. < 5%), over several years they can have a significant effect on catch rates. For this reason it is important to consider annual fishing power increases when forecasting the long-term effects of management measures with computer models. Assumptions made about the precise annual increase in fishing power can have a significant affect on the outcomes of forecasts and the advice provided to managers and industry Dichmont et al. 2001; Haddon, 2001.

This section of the report describes the rates at which devices, fishing gears and other performance-related changes have been adopted in the main sectors (eastern king prawn, scallop fishery, the north Queensland tiger/endeavour prawn and the Torres Strait tiger/endeavour prawn) of the QECTF over the last 30 years. It also compares

and contrasts the sectors and offers explanations for the differences. Quantitative estimates of the effects of the devices on fishing power are provided in Chapter 6.

5.3 MATERIALS AND METHODS

Information on which devices and technologies were adopted by fishers, and when they were adopted, was obtained from a purposely-designed survey of 344 past and present fishing vessel owner/operators selected randomly from the entire trawl fleet of 900 vessels that had fished during 1997 and 1998. A copy of the survey questionnaire is provided in Appendix 15.3.

The questionnaire considered a number of different vessel characteristics thought to effect fishing power. The 344 interviews represented a response rate of 85% of the 406 operators who were initially contacted. Overall, the sample included vessels that collectively accounted for about 40% of each sector's total catch between 1989 and 1999. A breakdown of the number of owners or skippers operating in each sector in each year who were interviewed is provided in Table 5.3.1. It is important to note a) that many operators work in more than one sector and therefore the technical changes in their fishing operations applied across the sectors they worked in, and b) the general decline in the numbers of owners and skippers the further back in time the survey sought information for.

Interviewees were asked to provide written records of vessel characteristics for the interview. Changes in the following characteristics and the date of each change were recorded for each vessel:

- Skippers (owner operated, relative of owner, or non-relative)
- Vessel length, engine power (HP), average trawl speed (knots), fuel capacity (litres), propeller size (inches) and the presence or absence of a propeller nozzle.
- Navigation equipment (presence or absence of global positioning systems (GPS) and plotters, and computer mapping software).
- The presence or absence of try-gear (try-gear is a small (1–3 fathom) net used for frequent 10–20 minute sampling of trawl grounds).
- The use of bycatch reduction devices (presence or absence).
- Trawl net configurations:
 - Number of nets (single, double, triple, quad or five nets).
 - Total net head rope length (fathoms) combined for all nets.
 - Net mesh size (mm).
 - Type of ground chain (fixed drop chain, drop chain with sliding rings, drop rope and chain combined, looped chain or other less common configurations) and chain size (mm).
- Type of otter board types (Bison, Flat, Kilfoil, Louvre or other less common types) and size (total board area = board length × width).

Table 5.3.1 Breakdown of the number of owners and skippers operating in the major Queensland east coast and Torres Strait trawl sectors in each year that were interviewed as part of the questionnaire.

Fishing year	Eastern king prawn	Scallop	North Queensland tiger/endeavour prawn	Torres Strait tiger/endeavour prawn
1969	1		2	
1970	3	2	2	
1971	3	2	2	
1972	4	2	3	
1973	5	2	4	
1974	9	5	6	1
1975	11	5	12	1
1976	18	11	13	1
1977	19	12	14	1
1978	20	13	18	1
1979	27	18	31	6
1980	34	26	40	8
1981	40	33	45	10
1982	46	39	51	13
1983	52	44	60	16
1984	55	48	68	17
1985	59	51	71	18
1986	65	60	82	21
1987	74	68	94	27
1988	89	78	109	31
1989	100	89	128	39
1990	112	100	138	43
1991	123	112	149	45
1992	132	119	161	50
1993	140	130	170	54
1994	155	145	194	62
1995	172	170	212	75
1996	188	185	231	79
1997	201	198	242	84
1998	200	198	245	87
1999	194	196	239	86
2000	176	180	80	29

It is also important to note the further back in time that the project sought information through the interviews, the less reliable the information was likely to become. The reason for this was because the early observations (those prior to 1975 for the east coast sectors and prior to 1980 for Torres Strait) were based on the recollections of a very small number of operators who were still available for interview, and also due to memory loss. The Torres Strait trawl fishery was in a developmental phase throughout the 1970s and prior to about 1975 the fleet size was very small (Pyne and Dall, 1976; Storrs, 1987). Observations from recent years (i.e. 1980–2000) were likely to be more accurate because they were based on larger sample sizes (i.e. more interviewees) and presumably, more accurate recollections.

5.4 RESULTS

5.4.1 Trends in skippering vessels

Results from the questionnaire confirm a decline in the proportion of owner-operator skippers and a corresponding increase in non-family skippers (Figure 5.4.1). In the 1960s and early 1970s it was commonplace for the skipper to also be the vessel owner. The decline in owner-skippers was most notable for Torres Strait where the proportion fell from 1.0 in the early 1970s to around 0.2 in 2000. The proportion of family members (typically sons) as skippers has remained relatively low at about 0.1 across all sectors since the mid-1970s. The proportion of non-family skippers has risen consistently since the early 1970s and may continue to rise. In 2000, the proportion of non-family skippers in Torres Strait was about 0.6. Trends for the east coast sectors (i.e. eastern king prawn, scallop and tiger/endeavour prawn) were very similar and differed from the Torres Strait fleet.

5.4.2 Changes in general vessel characteristics

Temporal changes in the characteristics of vessels operating in each sector are provided in Figure 5.4.2 and Figure 5.4.4 and include information on average vessel size, engine power, trawl speed, fuel consumption and propeller details. Vessels operating in Torres Strait were significantly larger and more powerful than those operating in the east coast sectors (Figure 5.4.2). The fuel capacity of Torres Strait vessels (currently about 20 000 L) was 2–3 times that of the east coast vessels (about 6000 L) possibly due in part to the remoteness of the region.

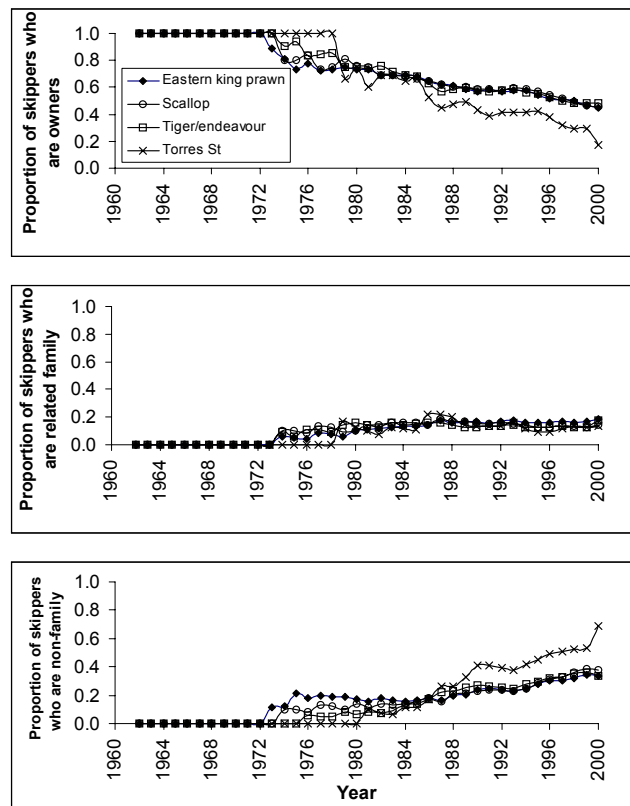

Figure 5.4.1 The proportion of different skipper-types (owner, family member or non-family member) over time in the major Queensland east coast trawl sectors.

In general, differences between the east coast sectors were slight, with the exception of trawl speed. Engine power, trawl speed, fuel capacity and consumption, propeller size and pitch, and gearbox ratios increased across all sectors from the mid-1980s to 2000. For all of the east coast sectors, the average reported engine power increased from about 190 hp in 1980 to about 280 in 2000 (Figure 5.4.2). The average reported engine power of Torres Strait vessels increased from 250 hp to 350 hp over the same period. Trawl speed was notably higher in those sectors targeting tiger/endeavour prawns, particularly in Torres Strait, and lowest in the scallop fishery. Trawl speed for vessels in the eastern king prawn sector was intermediate.

DESCRIPTION OF TECHNOLOGICAL CHANGES

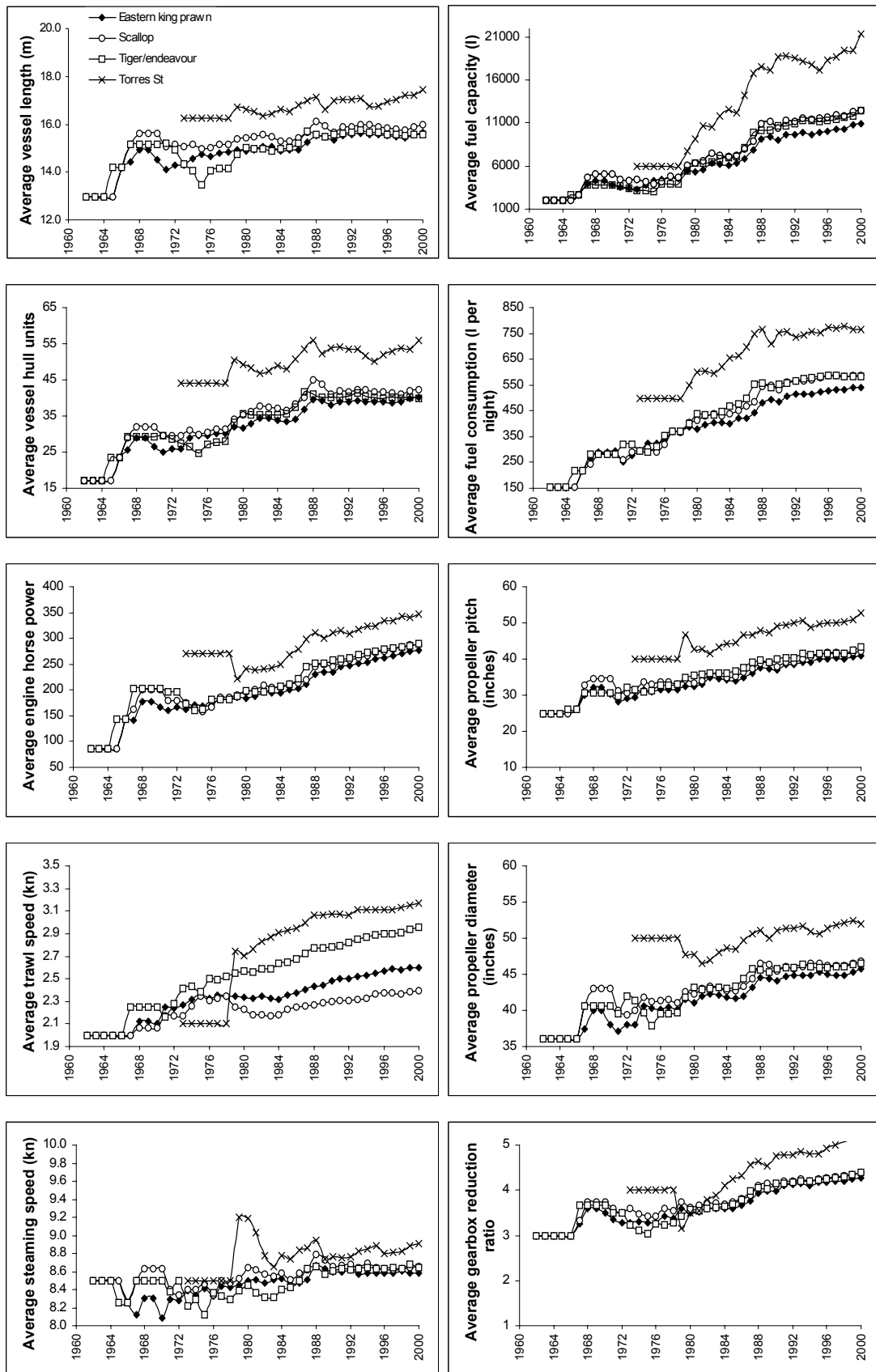

Figure 5.4.2 Long-term trends in general vessel characteristics in the Queensland east coast and Torres Strait trawl fisheries.

The proportion of vessels using propeller nozzles (Figure 5.4.3) in the Torres Strait fishery increased markedly from the late 1970s and reached 0.97 in 2000 (Figure

5.4.4). For the east coast sectors the rate of adoption was slower and reached about 0.6 by 2000. The data suggest the proportion of operators using nozzles is slightly higher in the tiger/endeavour prawn sector.



Figure 5.4.3 Propeller with nozzle, from Queensland east coast trawler.

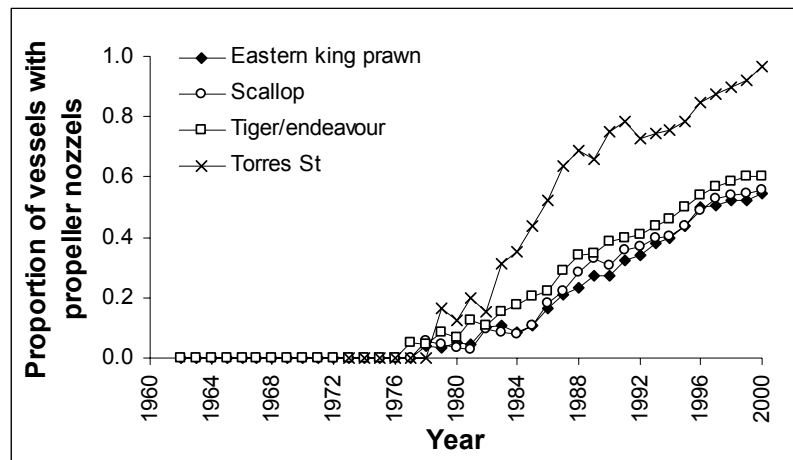

Figure 5.4.4 Long-term trends in the proportion of vessels using propeller nozzles in the Queensland east coast and Torres Strait trawl fisheries.

Characteristics that have not changed significantly from the mid-1980s to 2000 include vessel length and number of hull units, and steaming speed, although there is evidence of increased vessel size in Torres Strait from 1998 to 2000.

5.4.3 Try gear

Try gear (Figure 5.4.5) was adopted quickly in Torres Strait in the late 1970s and by the early 1990s was used on about 80% of vessels (Figure 5.4.6). Rates of adoption were lower and occurred later in the scallop and eastern king prawn sectors and by 1984 it was still only used on about 5% of vessels (Figure 5.4.6). Since then there has been a steady increase in usage and by 2000 try gear was used by about 64% of operators in the scallop and eastern king prawn fisheries. The data suggest that try gear may be more effective in the northern tiger prawn sectors (Torres Strait and north Queensland) compared with the eastern king prawn fishery.



Figure 5.4.5 Beam trawl try gear on board vessels in the eastern king prawn fishery.

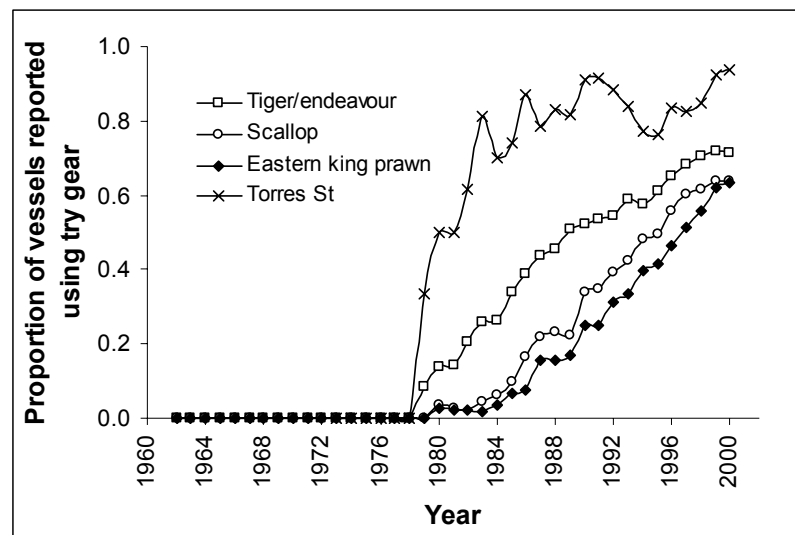

Figure 5.4.6 The proportion of vessels using try gear in the major trawl sectors of the Queensland east coast and Torres Strait from 1960–2000, based on results from the questionnaire.

The average headrope length of the try gear nets has remained at about 1.9 fm since the mid–1980s and does not differ between sectors. Fishers reported using either otter board or beam trawl type try gear, with the former being the most common. Since 1985, 83% of fishers using try gear in the eastern king prawn fishery reported using

the otter-board type. Slightly higher rates were reported for the scallop (94% usage) and tiger/endeavour prawn fisheries (97% usage). Information on how frequently try gear was used throughout the night was also obtained through the questionnaire and of those operators using the device, the majority (80–100%) used it continuously throughout the night (Figure 5.4.7). This trend was consistent across sectors.

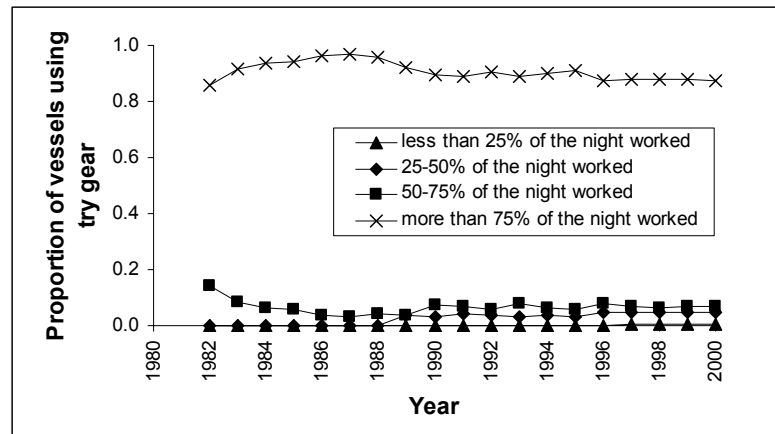

Figure 5.4.7 The proportion of vessels using try gear at different frequencies throughout the night in the north Queensland tiger/endeavour prawn fishery.

5.4.4 Changes in trawl gear (net sizes and configurations, ground chains and otter boards)

The configuration of nets used in each sector has changed markedly over time and differs between sectors (Figure 5.4.8). Again, it is worth noting that the data and trends from recent years (1990–2000) are likely to be more accurate than those from the 1960s and 1970s. For the years prior to 1975, the results were based on the recollections of a very small sample size of interviewees. Nevertheless, some general trends are apparent. For example, in the late 1960s a high proportion of vessels towed a single net, particularly in the tiger and king prawn sectors. Over the following years this trend declined and by the early 1980s only a small proportion of vessels in the deep water eastern king prawn fishery continued with single nets. Since then, and to the present day, the proportion of vessels towing single gear has been negligible.

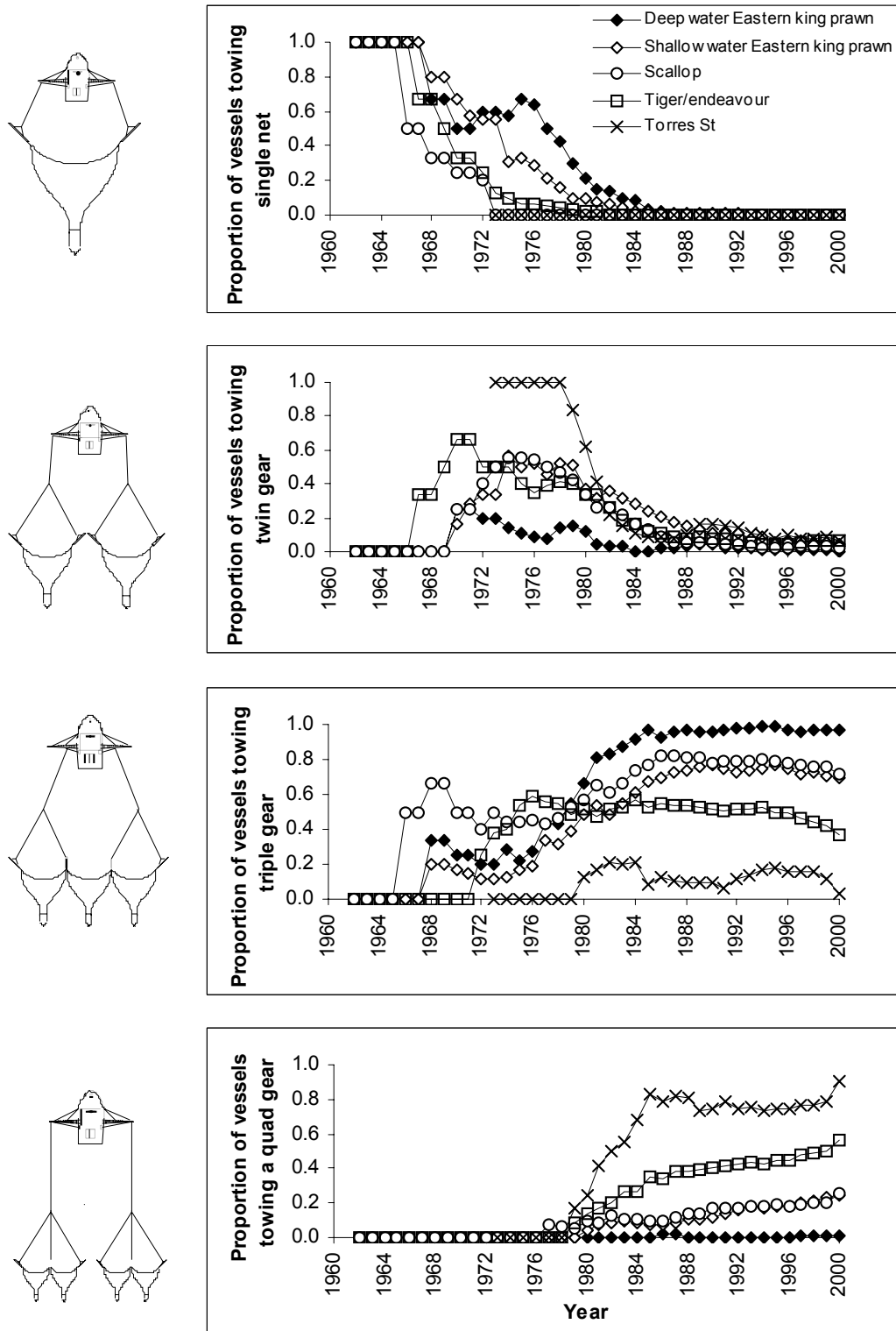

Figure 5.4.8 Changes in the configuration of nets used in each of the major Queensland trawl sectors from 1960 to 2000, based on the questionnaire results.

Deployment of twin gear (two nets) was common in most sectors in the early 1970s (Figure 5.4.8) but declined from the mid-1970s to about 1992 and has remained under about 10% in each sector ever since. The proportion of vessels in the deep water king

prawn sector that have used twin gear was consistently lower compared with the other sectors and has been negligible since the early 1980s. The reason for this is because most deep water vessels use triple gear (three nets) as it is widely considered to offer greater stability and safety in the deep water, especially during hook-ups (i.e., when the nets get caught on the bottom and the vessel is immobilised and vulnerable to capsizing). A high proportion (0.8–1.0) of deep water king prawn vessels have continued to use triple gear since the early 1980s. In contrast, about 0.6–0.7 of the scallop and shallow water king prawn vessels, and less than 0.5 of the north Queensland tiger/endeavour prawn vessels, have used triple gear since the early 1980s. The proportion of vessels using triple gear has been lowest in Torres Strait.

Quad gear (four nets) is most commonly used in the tiger prawn fisheries of north Queensland and Torres Strait (Figure 5.4.8). The proportion of Torres Strait vessels using quad gear increased from about 0.2 in 1980 to about 0.9 in 2000. Rates of adoption in the scallop and shallow water king prawn sectors were similar and increased from about 0.1 in 1980 to about 0.2 in 2000. The proportion of deep water eastern king prawn vessels using quad gear remained at negligible levels throughout the fishery's history. Since 1995, a small number of operators who were interviewed in each sector reported using five nets, but because of the low incidence of use (fewer than three operators in any year) it is difficult to confirm any trends for this particular type of gear.

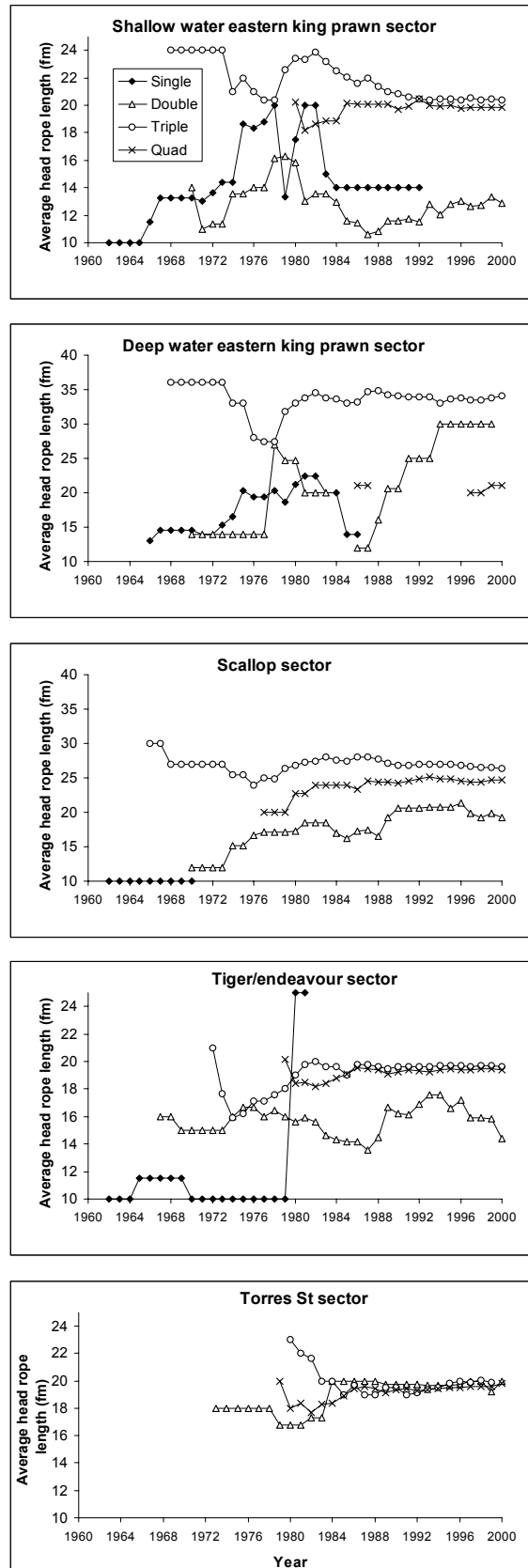

Figure 5.4.9 Time series of the average total head rope length of nets in each of the Queensland trawl sectors from 1960–2000, based on the questionnaire results.

Long-term trends in the size of the nets used in each configuration type and sector (Figure 5.4.9) are affected by net size regulations and indirectly by regulations on vessel size. For example, the maximum total combined foot and head rope lengths are restricted to 88 m in depths less than 50 fathoms (fm) and 184 m rope in depths greater than 50 fm [Fisheries (East Coast Trawl) Management Plan 1999]. These equate to a maximum allowable head rope length of about 44 m (22 fm) and 92 m (45 fm) in the shallow and deep water, respectively. Head rope lengths for the most commonly used gear types (triple and quad gear) have plateaued and stabilised since the early 1980s (Figure 5.4.9). In the tiger/endeavour prawn and shallow water eastern king prawn sectors, average head rope length has stabilised at, or just under, the maximum allowable of 22 fm since the early 1980s. In the deep water eastern king prawn sector the average head rope length of triple gear has remained relatively stable at about 35 fm since the early 1980s. This is well below the maximum (92 m or 45 fm) that fishers can tow in the deep water, and is probably a result of limitations on vessel size (Figure 5.4.9). Few operators in the deep water appear to be towing the maximum allowable net sizes.

Results from the questionnaire provided insight into the types of ground chain (Figure 5.4.10) used on trawl nets and how they have changed over time. Reported chain types included drop chain, drop mud rope, drop chain with sliding rings, dangles or Christmas-tree drops, looped ground chain and drop rope with chain.

Over the past 20 years there has been relatively little change in the types of ground chain used throughout the different sectors (Figure 5.4.11), with the ‘drop chain’ type being the most widely used, by far (Figure 5.4.10).

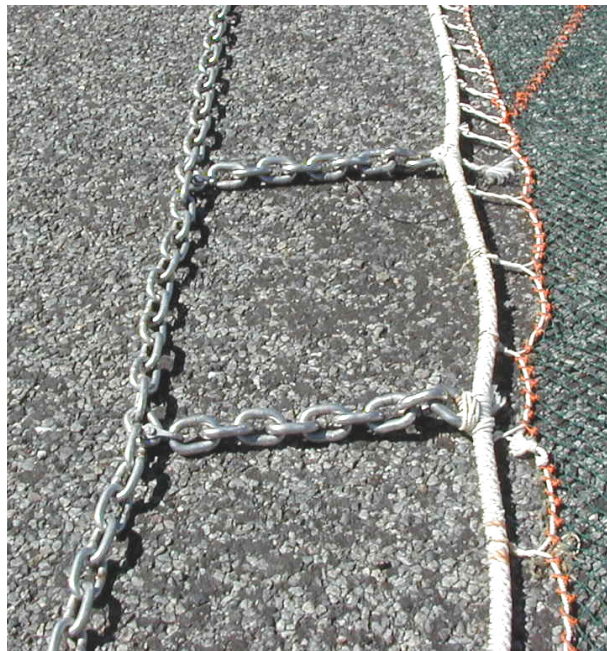

Figure 5.4.10 Photograph of ‘drop chain’ – the most common ground chain type used in the Queensland east coast and Torres Strait trawl sectors.

Between 0.8 and 1.0 of the north Queensland tiger/endeavour prawn and Torres Strait fleets use drop chains, while the proportion is currently at about 0.6 in the scallop sector and shallow water eastern king prawn sectors. In contrast, ‘looped chain’ was

most frequently used in the deepwater eastern king prawn fishery up to the early 1990s and has only been superseded by drop chains in recent years. For most sectors, the proportion using drop chain has increased slightly in recent years. The deep water king prawn fishery has retained the highest variety of ground chain types, with similar proportions of the fleet currently using drop chains, looped chains and 'other' types.

The average gauge of drop chain increased in all sectors from 8.0 mm in the 1960s and 1970s to slightly under 10 mm in 2000 (Figure 5.4.12). Increases occurred earlier in the scallop sector and appear to have resulted in slightly higher averages compared to the other sectors. Average gauge size has remained slightly smaller in the shallow water eastern king prawn sector. The gauge in the deep water fishery remained comparatively small during the 1970s but increased markedly from the mid-1980s. For most sectors, average chain gauge has remained relatively stable since the late 1980s.

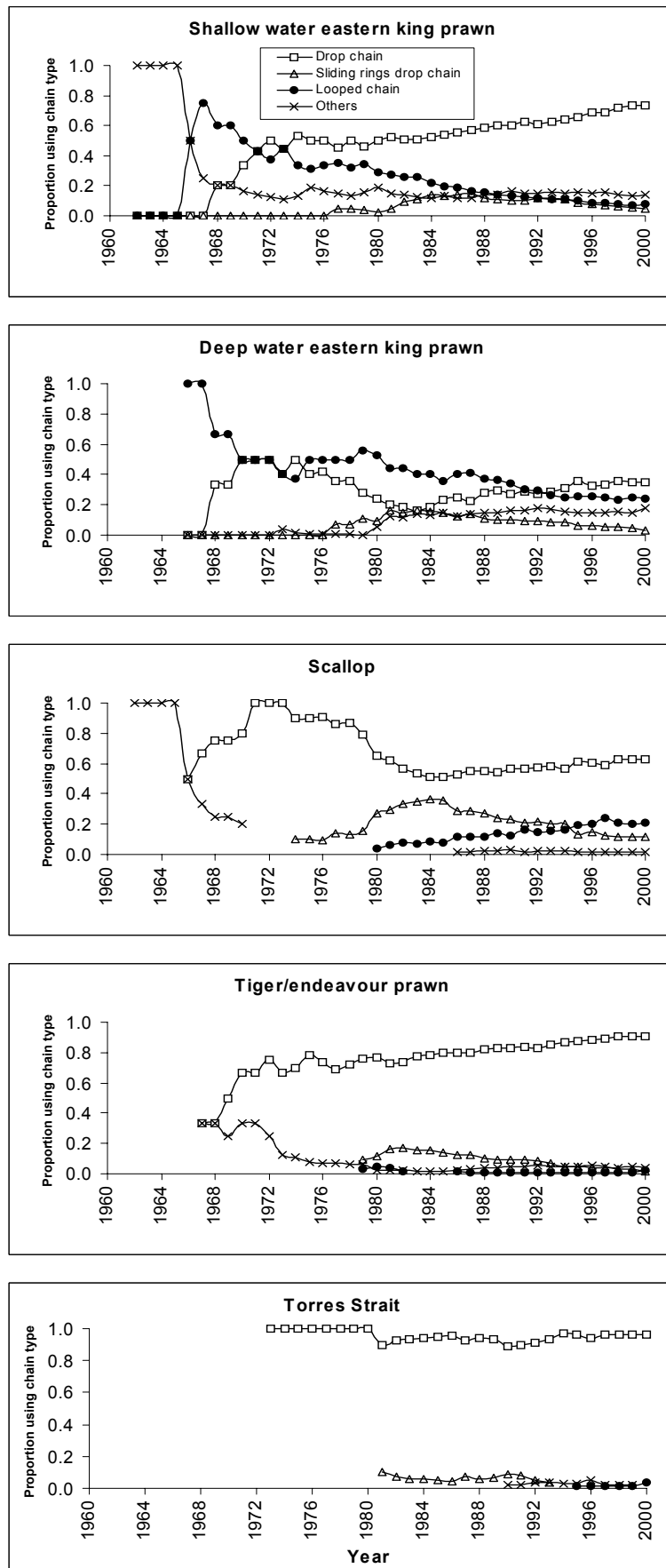

Figure 5.4.11 Types of ground chain used in the different trawl sectors from 1960 to 2000, based on results from the questionnaire.

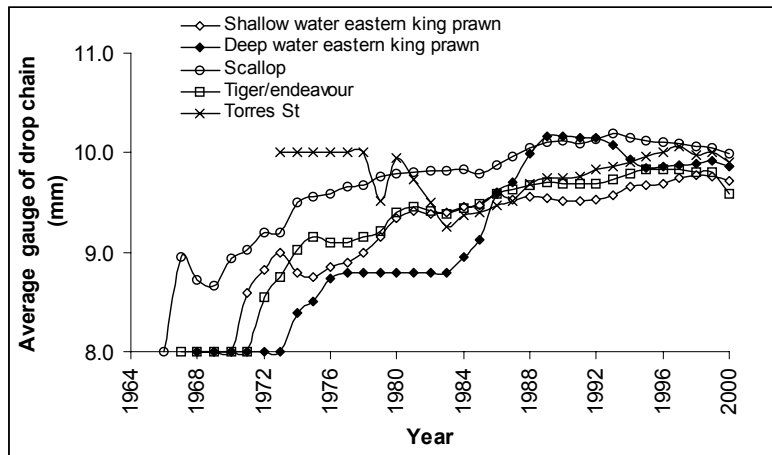

Figure 5.4.12 Long-term trends in the average gauge of drop chain used in each sector, based on results from the questionnaire.



Although flat otter boards (Figure 5.4.13) have been the most common board type used across all sectors over the last 40 years, their use is declining, particularly in the tiger/endeavour prawn fisheries (Figure 5.4.14). In the Torres Strait fishery, the proportion of vessels using flat boards declined from 1.0 in the mid-1970s to about 0.2 in 2000. Over the same period there was an increase in the adoption of Kilfoil or louvre boards, and Bison boards. Flat boards still appear to be preferred in the deep water eastern king prawn fishery where they are used by about 0.9 of vessels. Other boards used by fishers included the Collins, superflow and perfect type boards. However, the proportion using these was very low (i.e., < 0.01).

Figure 5.4.13 Types of otter boards used in the Queensland east coast trawl fishery. Above is large flat otter board with skid, as used in triple gear in deep water eastern king prawn fishery. Below are two Bison boards with skid in between, used in quad gear in the tiger/endeavour prawn fishery.

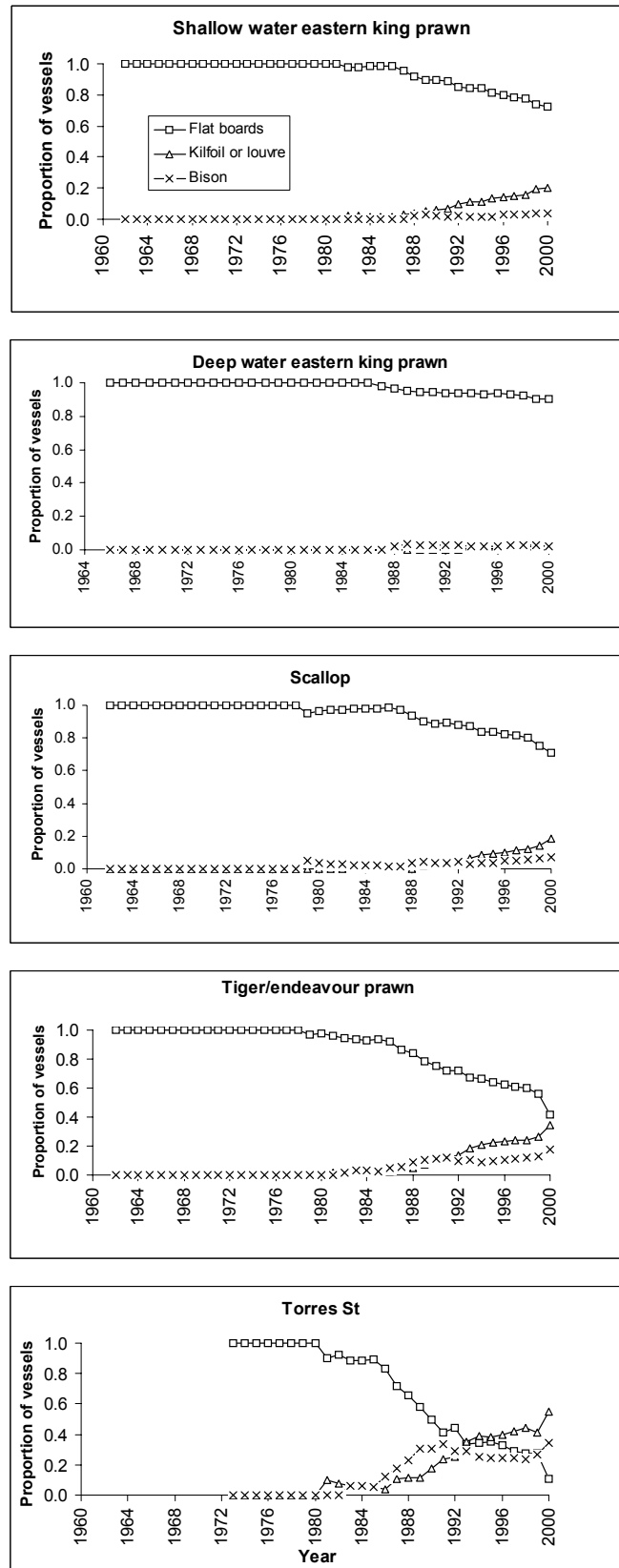

Figure 5.4.14 The proportion of vessels using different types of otter boards in each of the major Queensland trawl sectors from 1960–2000, based on the questionnaire results.

5.4.5 Uptake of turtle excluder devices (TEDs) and bycatch reduction devices (BRDs)

TEDs and BRDs were trialled voluntarily in the Queensland east coast otter trawl fishery and in Torres Strait in the mid- to late-1990s and progressively made mandatory in different areas and sectors between 1999 and 2002. TEDs were made mandatory in the scallop sector on the 1st July 2001 and on the 1st January 2002 in the deepwater. BRDs were made mandatory in the scallop and deepwater (depths > 50 fm) sectors on the 1st July 2001. As of January 2002, TEDs and BRDs were compulsory in all of the sectors (eastern king prawn, scallop, north Queensland tiger/endeavour prawn and Torres Strait) considered herein.

Interviewees reported adopting a wide range of devices. The TEDs included the Nordmore grid, 'own design' TED, standard US TED, unspecified TED, Kevin Wicks TED, AUSTED, Super shooter, rectangle grid and Seymour, while the BRDs included the V-cut, square mesh window, Big Eye, unspecified BRD, Fisheye, Neil Olsen BRD, radial escape section and square mesh codend.

Prior to 1995, the reported use of TEDs and BRDs was negligible (Figure 5.4.15). Use of the devices increased dramatically in 1999 and by 2000 almost all operators in the north Queensland tiger/endeavour prawn and Torres Strait sectors who were interviewed reported using at least one device (either a TED or a BRD), or both. The reported use was lower for the eastern king prawn sector (0.79) and markedly lower for the scallop sector (0.15). The reason for the low uptake in the scallop sector appears to be related to difficulty in tuning the TEDs to work effectively in the Seibenhauser type nets that are often used in the scallop fishery, and the high incidence of sponges on some of the scallop grounds clogging the TEDs.

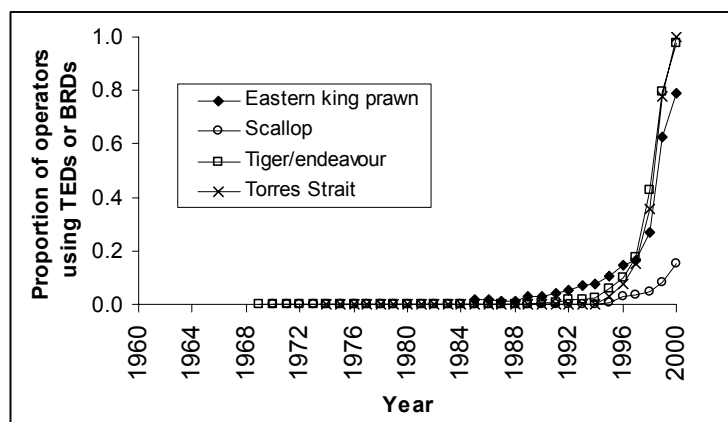

In 2000, the most commonly used devices in the eastern king prawn fishery were the Kevin Wicks TED, Big Eye, Fish Eye and V-cut, in

decreasing order. In the north Queensland tiger/endeavour prawn and Torres Strait sectors, the most commonly used devices were Kevin Wicks TED, Big Eye, square mesh window, Fish Eye and radial escape section. Although usage of the devices in the scallop sector was low, the most commonly used devices in 2000 were the Big Eye and non-specific 'own design' BRDs and TEDs.

Figure 5.4.15 The reported use of TEDs and BRDs in the Torres Strait and major Queensland east coast trawl sectors, based on results from the questionnaire.

5.4.6 Changes in navigational technology

The reported rates of adoption for navigational technologies are provided in Figure 5.4.16. Devices that are fully adopted and used by almost all operators (i.e., saturation) include autopilot, colour echo sounder, GPS, radar and plotters.

Technologies that continue to be adopted (i.e., not yet reached saturation) include computer mapping software, differential GPS (DGPS) and the integration of GPS and autopilot. Again, a number of devices were adopted earlier in the Torres Strait, including colour echo sounder, computer mapping, DGPS, GPS, GPS autopilot, sonar and plotters. Adoption of computer mapping software in the Torres Strait was rapid and approached saturation by 2000.

Satellite navigation began to be adopted in the 1970s, but was largely ineffectual due to relatively low spatial resolution and the low frequency of satellite availability (once every 6–12 hours). GPS began to be adopted in the mid–1980s and by 1998 was used by almost every operator (Figure 5.4.16). GPS offered fishers improved spatial accuracy for trawling, with a precision of about ± 50 m. In 1994 operators started to use DGPS which improved their precision to a maximum achievable ± 1 m, depending on the level of subscription the individual operator paid for. The DGPS signal was frequency modulated (FM) and unavailable for the entire coastal zone. Vessels working in southeast Queensland and comparatively close to major population centres were more likely to be able to pick up the signal. Since the United States removed the imprecision of the GPS satellite signal in 1999 (initially implemented for military defence), the difference between GPS and DGPS has been significantly reduced. Both GPS and DGPS now offer similar precision and therefore there is no real need for fishers to adopt DGPS.

The adoption and use of sonar has generally remained low (i.e. < 0.2), except for Torres Strait where reported usage peaked at about 0.5 in the 1980s. While the Torres Strait sector appears to adopt navigational technologies relatively early, the eastern king prawn sector has generally been the slowest in adopting the technologies. For example, the king prawn fishery had the slowest rates of uptake for colour echo sounders, computer mapping software, GPS and DGPS, and integrated GPS and autopilot.

5.4.7 Changes in communication technology

The proportion of vessels using 27 MHz radio increased throughout the 1970s and peaked at about 80% in the east coast sectors in the mid–1980s (Figure 5.4.17). Since then, the proportion of vessels deploying the device has declined to around 60%. Although the proportion of vessels using 27 MHz in Torres Strait was consistently lower, the same declining trend apparent and by 2000 only about 25% of Torres Strait vessels were using the device.

High (HF), very high (VHF) and ultra high frequency (UHF) radios were adopted by almost all operators in the Torres Strait in the mid–1970s (Figure 5.4.17). The rates of adoption were lower for the east coast, especially for the VHF and UHF.

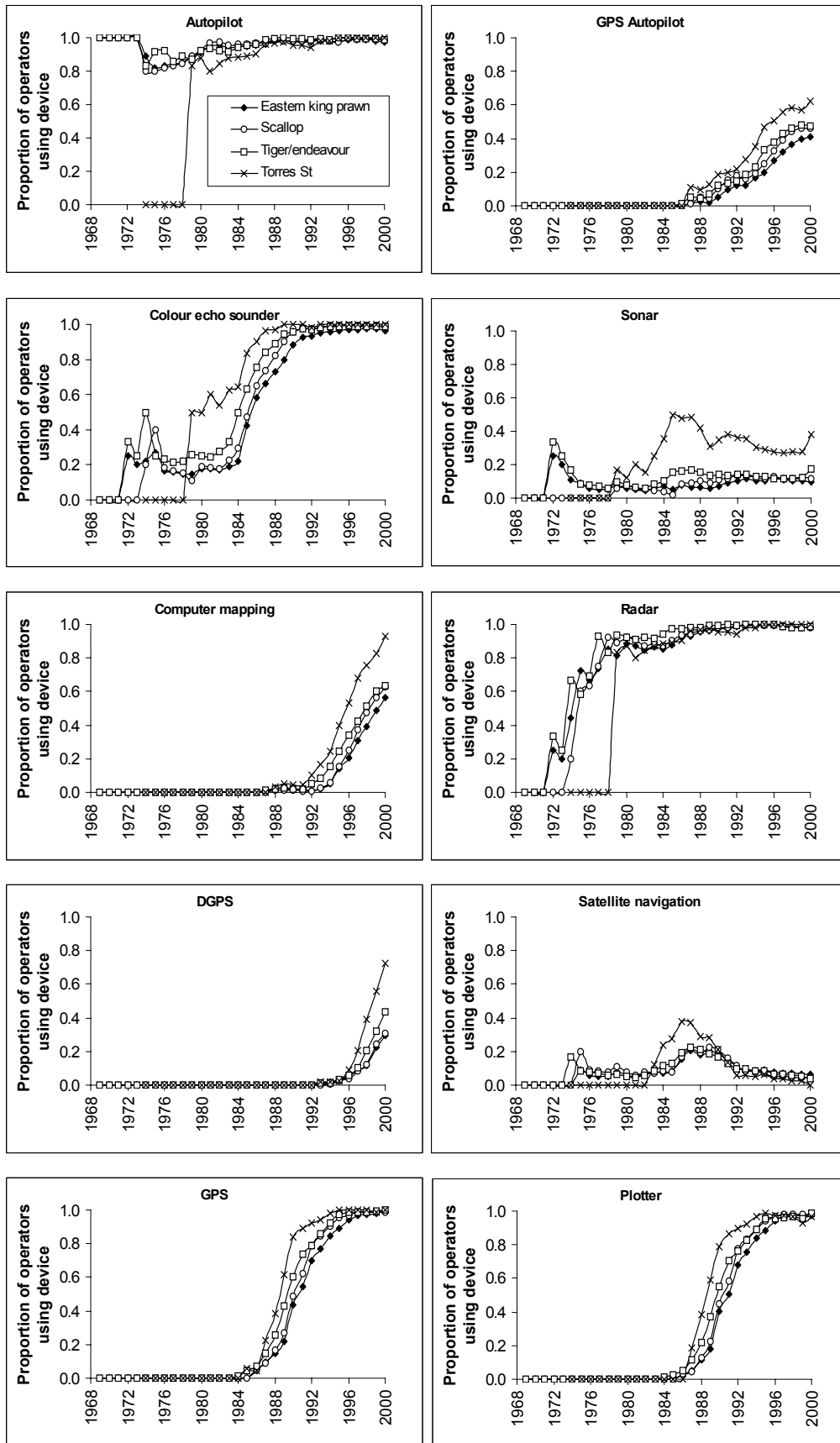

Figure 5.4.16 The adoption of navigational technologies in the major Queensland east coast trawl sectors and Torres Strait from 1969 to 2000, based on the questionnaire results.

Mobile phone usage in the Queensland east coast sectors increased markedly throughout the 1990s and has peaked at around 100% in the scallop and eastern king prawn sectors. The rate of adoption is lower in the tiger/endeavour prawn fishery and lower still in Torres Strait. Satellite phone usage is increasing at a high rate in the Torres Strait (Figure 5.4.17). The proportion of vessels using facsimile and emails has remained low (10–20%) on the east coast but is around 30–40% in Torres Strait.

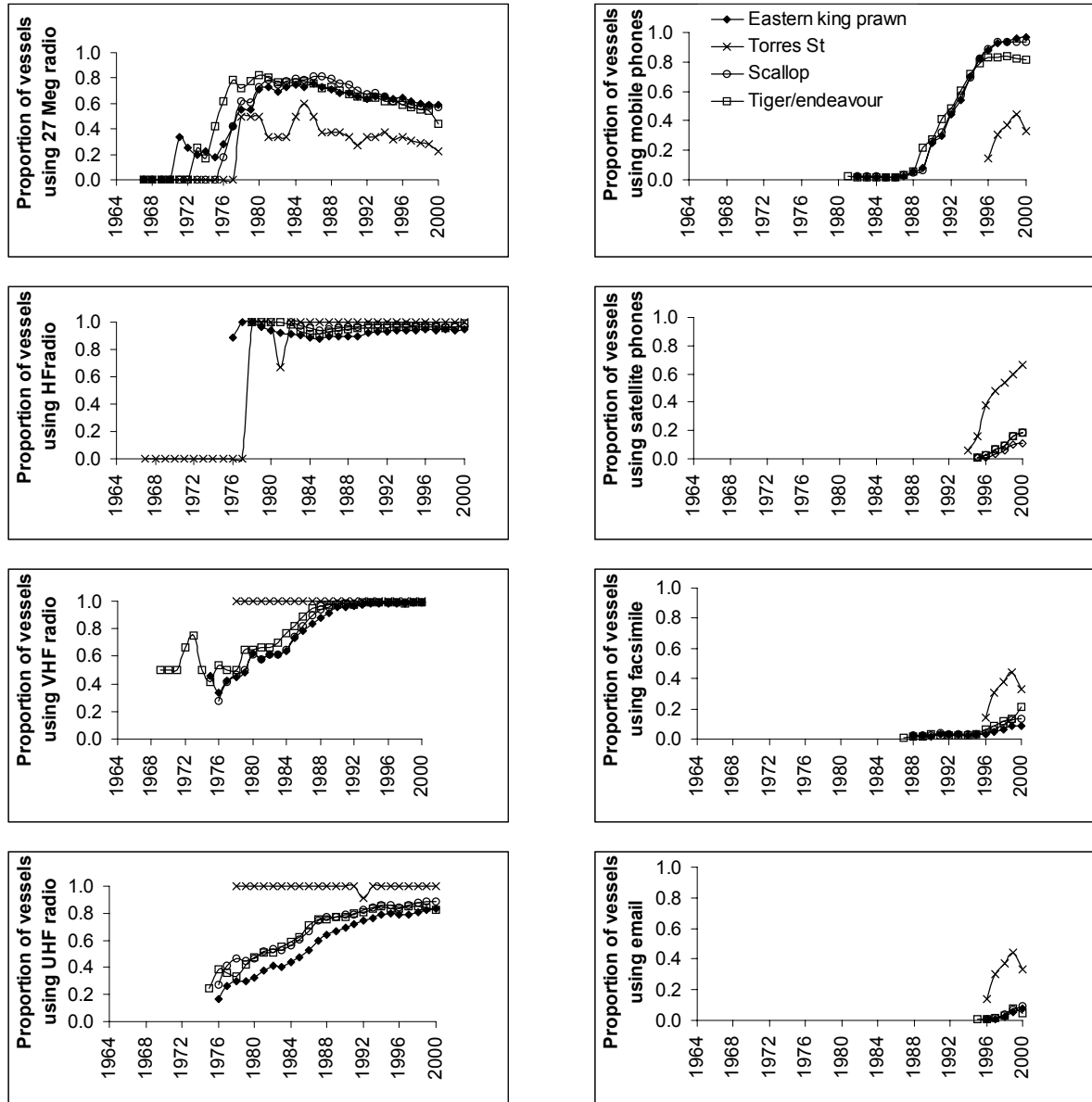

Figure 5.4.17 Long-term trends in the adoption of radio and telecommunication devices in the Queensland east coast and Torres Strait trawl fisheries, based on the questionnaire results.

5.5 DISCUSSION

This chapter has attempted to capture the influential technical changes affecting fishing power in the Queensland east coast and Torres Strait trawl fisheries over the past 40 years (1960–2000) and quantify their rates of adoption. Similar studies were undertaken by Brunenmeister 1981 for the United States shrimp stocks in the Gulf and Mexico, Chifamba 1995 for the Lake Kariba sardine fishery in Zimbabwe and Bishop and Sterling 1999 for Australia's Northern Prawn Fishery.

Brunenmeister (1981) examined change in five vessel characteristics: gross tonnage, vessel length, horsepower, net number and average net size. Chifamba (1995) examined vessel mobility, engine type and horsepower, echo sounder, radio usage, winch type, net diameter and depth, the type number and wattage of underwater lights, and interestingly the insurance value of the vessel. The survey of Bishop and Sterling (1999) sought information from fishers on vessel and trawl gear specifications, BRD and TED usage, searching capabilities, including deployment of spotter planes, fleet cooperation factors, navigational equipment and factors affecting the swept area of the trawl gear. While the most influential technologies appear to have been considered in the present study, it is important to acknowledge that some influences may not yet be identified and that new technologies will continue to be invented and adopted into the future.

5.5.1 *General vessel characteristics*

The results quantify the changes and improvements in fishing gear and technology in the Queensland and Torres Strait trawl fisheries over a 40-year period (1960–2000). In general, the Torres Strait fleet has been technically more advanced than vessels working in the Queensland east coast sectors. For example, Torres Strait vessels have consistently been larger, with greater fuel consumption, more powerful engines, gearboxes and propellers, and greater average steaming and trawl speeds (Figure 5.4.2). The rate of adoption of propeller nozzles (Figure 5.4.4) was rapid in Torres Strait, resulting in almost total (100%) adoption by 2000. Differences in general vessel characteristics between the east coast sectors (eastern king prawn, scallop and tiger/endeavour prawn) over the 40-year period were slight, with the exception of trawl speed. While trawl speed has increased in each sector, it is significantly higher for the tiger/endeavour prawn sectors and lowest for the scallop sector.

Try gear was adopted earlier in the tiger/endeavour prawn sectors (Queensland and Torres Strait) compared with the eastern king prawn and scallop sectors. One of the reasons why it has not been adopted as readily in the deep water king prawn vessels is most likely due to the depth at which trawling occurs, because it increases the time it takes to shoot-away the gear and to retrieve it. Try gear is basically used to take 'a quick look' at prawn/scallop catch rates and densities on the bottom. If the try gear catch rates are favourable, then the vessel turns around and trawls over the same area again, all the while keeping the main trawl nets on the bottom. However, when the depths are great (i.e. 200–300 m) the length of wire needed to shoot the try gear away increases and therefore it takes several minutes to lower the gear to the bottom and retrieve it. The wear and tear on the winches is also increased as a result of the greater depths. Furthermore, because of the extended time required to shoot away and retrieve nets, crews commonly only undertake 2–3 trawls per night in the deep water, with

some members choosing to sleep between trawls rather than continually working the try gear. For these reasons, try gear is unlikely to be adopted throughout the entire east coast fishery.

5.5.2 Changes in nets, ground chains and otter boards

Long-term trends in the configuration of the nets used in the Torres Strait and Queensland east coast trawl sectors were characterised by the dominance of single nets in the 1960s and early 1970s, followed by the progressive adoption and eventual dominance of triple gear in the scallop and eastern king prawn sectors, and quad gear in the tiger/endeavour prawn sectors (Figure 5.4.8). Adoption rates for triple gear have stabilised since the late 1980s, but there is some indication of a slight increase in the use of quad gear over the last decade.

For some gear configurations and sectors, there was a progressive increase in the average head rope length of nets throughout the 1960s and 1970s (Figure 5.4.9). This trend appears to have ceased by the mid-1980s, most likely as a result of net length and vessel length restrictions. For those sectors that occur in depths less than 50 fm, the average head rope length remains slightly under the maximum allowable of 44 m (22 fm). However, for the deep water (> 50 fm) the average head rope length is well under the maximum allowable of 92 m (45 fm), possibly as a result of vessel length regulations limiting the size of nets that vessels can tow. Drop chains are, by far, the most commonly used ground chain type used throughout all sectors and there is evidence of a consistent increase in their rate of adoption (Figure 5.4.11). The deep water king prawn sector differs from the others in that it appears to use a wider range of ground chain types, including looped chain, drop chain and others. The results suggest there have been few advances in ground chain types, or adoptions of alternative ground gear, over the last 20 years. There was a general increase in the average chain gauge size across all sectors from the early 1960–70s to 2000 and by 2000 the average gauge varied from 9.5–10.0 mm, depending on the sector. The Management Plan, which became effective in early 2000, capped the maximum chain gauge size to 10.0 mm in shallow water (depths < 50 fm) and 12.0 mm in the deep (depths > 50 fm).

Flat otter boards have been, by far, the most commonly used throughout the Torres Strait and Queensland east coast sectors since the early 1960s (Figure 5.4.14). However, their use has declined, particularly in the tiger/endeavour prawn sectors, where there has been a shift toward Kilfoil or louvre type boards. A high proportion of vessels (> 0.9) in the deep water eastern king prawn fishery have retained flat boards.

5.5.3 Uptake of TEDs and BRDs

The rates of adoption of TEDs and BRDs were also affected by the mandatory regulations introduced in the Management Plan in 2000. Results from the questionnaire indicate that, prior to about 1995, reported use of TEDs and BRDs was negligible and that usage increased markedly in most sectors in 1999 and 2000, although uptake in the scallop sector was still low in 2000 (Figure 5.4.15).

Robins et al. (2000) undertook a similar, voluntary survey of TED and BRD usage in the Queensland east coast and Northern Prawn Fisheries in the late 1990s. They posted the survey, which was specifically designed and limited to TED and BRD usage, to 758 Queensland east coast trawl licence holders and received 274 (36%) responses back. Robins et al. (2000) acknowledge that the responses may not necessarily reflect those of the whole fleet, but nevertheless provide some insight into the uptake of the devices at that time. They reported that about 1% of respondents indicated regular use of TEDs before 1st January 1997 and by the 1st May 1999 the proportion increased to about 20%. Thirty-eight percent of respondents reported using BRDs prior to 1st May 1999. While the reported use of BRDs was relatively high, the rates are generally consistent with those of the current questionnaire results (Figure 5.4.15).

5.5.4 Navigational improvements

Several navigational aids were adopted earlier and at a higher rate in the north Queensland tiger/endeavour prawn and Torres Strait fisheries than in the scallop and eastern king prawn sectors. This trend suggests that some technologies were introduced into the fishery ‘via the top end’, possibly from dual-endorsed (Queensland/Torres Strait/Northern Prawn Fishery) vessels, and progressively adopted over time in the southern scallop and eastern king prawn sectors.

By 2000, radar, autopilot, colour echo sounders, GPS and plotters were used on almost every vessel (100% adoption) in all sectors.

In general, trends in the adoption of navigational technologies were similar among the east coast sectors, and differed from those of the Torres Strait. GPS, computer mapping software and sonar were adopted at faster rates and are used by a higher proportion of Torres Strait operators compared with the east coast. The rates of adoption of GPS and plotters in Torres Strait, and the period they were adopted – late 1980s to early 1990s – were very similar to those reported by Robins et al. 1998 for the northern prawn fishery.

5.5.5 Changes in communication

Communication technologies have improved rapidly over the last decade, characterised by the uptake of mobile and satellite phones, facsimile and email (Figure 5.4.17). Again, trends among the Queensland east coast sectors were similar and differed from Torres Strait, largely because of the region’s remoteness. Uptake of satellite phones in the Torres Strait has been rapid and is continuing. There has been a consistent decline in the use of 27 MHz radios across all sectors since the early 1980s, with growing reliance upon HF, VHF and UHF radios.

In summary, the results from the questionnaire confirm that changes in vessel characteristics, fishing gear, navigation and communication have taken place over the last 40 years and that several technologies continue to be taken up by the major trawl sectors in Queensland and Torres Strait. New technologies are likely to emerge and be adopted in future. While the rates of adoption for some technologies have been quite rapid (i.e. adoption of trawl gear and GPS), their impact on fishing power is unknown.

Quantification of the effect of the different technologies on fishing power in each of the major sectors is investigated in the following chapter (Chapter 6).

5.6 REFERENCES

- Bishop, J., Sterling, D.J. (1999) 'Survey of technology Utilised in the Northern Prawn Fishery 1999'. CSIRO Division of Fisheries and Oceanography Report AFMA (Australian Fisheries Management Authority).
- Bowen, B.K., Hancock, D.A. (1985) Review of penaeid prawn fishery management regimes in Australia. In 'Second Australian National Prawn Seminar'. (Ed. PC Rothlisberg, Hill, B. J., Staples, D. J.) pp. 221–29. (NPS2: Cleveland, Queensland).
- Brunenmeister, S.L. (1981) Standardization of fishing effort and the production models for brown, white and pink shrimp stocks fished in US waters of the Gulf of Mexico. In 'Penaeid shrimps — their biology and management'. Key West, Florida, USA. (Ed. BJ Rothschild) pp. 187–211. (Fishing News Books Farnham, Surrey, England).
- Chifamba, P.C. (1995) Factors affecting fishing power of sardine fishing vessels and implications for the management of the fisheries on Lake Kariba, Zimbabwe. *Fisheries Management and Ecology* **2**, 309–319.
- Dichmont, C.M., Die, D., Punt, A.E., Venables, W., Bishop, J., Deng, A., Dell, Q. (2001) 'Risk analysis and sustainability indicators for prawn stocks in the Northern Prawn Fishery.' CSIRO Marine Research, FRDC 98/109, Cleveland.
- Haddon, M. (2001) 'Modelling and Quantitative Methods in Fisheries.' (Chapman and Hall: New York)
- Pyne, R., Dall, W. (1976) 'Report of the Working Group on Torres Strait Fisheries.' Department of Primary Industry, Canberra, ACT.
- Robins, C.J., Wang, Y-G., Die, D. (1998) The impact of global positioning systems and plotters on fishing power in the northern prawn fishery, Australia. *Canadian Journal of Fisheries & Aquatic Sciences* **55**, 1645–1651.
- Robins, J., Eayrs, S., Campbell, M., Day, G., McGilvray, J. (2000) 'Commercialisation of bycatch reduction strategies and devices within northern Australian prawn trawl fisheries,' FRDC Project Number 96/254.
- Storrs, M.J. (1987) 'Synopsis of the major Torres Strait Fisheries.' Department of Primary Industry, Bureau of Rural Science, Fisheries Technical Paper No. 87–1.

6 OBJECTIVE 2. ESTABLISH A STANDARDISED CATCH-PER-UNIT EFFORT SERIES: COMPARISON OF RELATIVE FISHING POWER BETWEEN DIFFERENT SECTORS OF THE QUEENSLAND TRAWL FISHERY, AUSTRALIA

6.1 ABSTRACT

The effects of improvements in fishing gear and technology on prawn and scallop catches from the Queensland trawl fishery were investigated. The species, the spatial distribution of the stocks, and management regulations were used to partition the fishery into five main sectors; Torres Strait tiger prawns, north Queensland tiger prawns, shallow water (< 50 fathoms) eastern king prawns, deep water (> 50 fathoms) eastern king prawns and saucer scallops. For each sector, annual changes in average relative fishing power were calculated as a function of the fishing gear and technology parameters estimated in a generalised linear model and the average and/or percentage use of different fishing gears and technologies in the sector. Over the 11 years from 1989 and 1999, fishing power for an average vessel increased at a low of 4% in the saucer scallop sector to a high of 27% in the shallow water eastern king prawn sector. Fishing power in the shallow water eastern king and Torres Strait tiger prawn sectors had the highest rates of increase and was largely attributed to vessels upgrading to larger engines. Increases in the number of vessels using global positioning systems and computer mapping software also contributed to increased fishing power in the two tiger prawn sectors. In the deep water eastern king prawn sector, increased fishing power was associated with net head rope length. However current management controls over engine size and head rope length are likely to limit this source of increase in fishing power. Fishing power in the scallop sector was associated with a relatively low average trawl speed of about 2.2 knots, which differed from the prawn sectors where higher catches were generally taken at trawl speeds of at least 3 knots. The fishing power results should be used to standardise fishing effort and catch rates in the stock assessments that are undertaken for each sector.

6.2 INTRODUCTION

Catch statistics are used as the basis of stock assessments in many fisheries. Because catch is a function of fishing effort and abundance of the fished population, trends in catch over time may reflect changes in the proportion of the population harvested, changes in abundance of the target species, or both (Quinn and Deriso, 1999). Stock assessments based on raw catch and effort data can produce biased predictions owing to efficiency changes in fishing effort through time and between fishing vessels. There is, therefore, a need to standardise average catches, for example by employing a regression model (Hilborn and Walters, 1992), to reduce the biases or variation in the data by accounting for factors affecting relative abundance and fishing efficiency. This results in a time series of catch and effort that is more representative of trends in population abundance.

A number of papers have been published on standardisation of catch and effort data. Regression approaches have been used to standardise average catches in the Gulf of Mexico prawn trawl fishery (Brunenmeister, 1984; Griffin et al. 1997), the Australian royal red prawn trawl fishery (Baelde, 1991) and to quantify the effects of global positioning systems (GPS) on average catches of tiger prawns in Australia's northern

prawn fishery (Robins et al., 1998). Bishop et al. (2000) further developed the analysis of Robins et al. (1998) by using the generalised estimating equations (GEE) regression approach to account for spatial and temporal correlations in the data. In contrast to the regression approach, Salthaug and Godø (2001) used a model for standardisation based on the relative fishing power between pairs of vessels fishing at the same time and place to estimate fishing power relative to a 'standard' vessel; see also Hall and Penn (1979). However, this method requires data with high spatial resolution and assumes that the chosen standard vessel's fishing power remains constant throughout the analysed time period.

The Queensland prawn trawl fishery is a limited entry fishery and currently comprises just over 500 otter trawlers, although the number of vessels in past years has been much higher (1413 vessels in 1980). It is the largest prawn trawl fleet in Australia in terms of the number of vessels. The fishery targets several species of penaeid prawns (mainly *Penaeus* spp. and *Metapenaeus* spp.), and mainly one species of scallop (*Amusium balloti*). It can be described as having identifiable sectors that are largely based on target species and geographic regions (Figure 6.2.1). Although a mandatory logbook system has been in continuous operation since January 1988, there has been little attempt to quantify changes in fishing power for individual vessels or for the fleet as a whole. For many years, Queensland east coast trawl operators were discouraged from upgrading to more powerful vessels through a boat replacement policy, which required owners to purchase and surrender one additional licence upon upgrading. This was commonly referred to as the two-for-one boat replacement policy; while effective at slowing the rate of increase in fishing power, it also had the detrimental effect of increasing the average age of the fleet (Glaister et al., 1993). This policy has now been replaced with management initiatives that are based on individual allocated days and vessel hull size as the principal means of limiting fishing effort.

Although the boat replacement policy was effective at limiting the fishing fleet's size, it is generally argued that the fishing power of an average vessel in the fleet has continued to increase due to technological advances in fishing gear, vessel performance, navigation systems and telecommunications. In this chapter we used linear regressions (McCullagh and Nelder, 1989) to examine the effects of these technologies on catches in the five major sectors of the Queensland east coast trawl fisheries (Figure 6.2.1) and to quantify the average annual rate of increase in fishing power. The sectors are: i) the Torres Strait, which mainly targets brown tiger prawns (*Penaeus esculentus*) and endeavour prawns (*Metapenaeus endeavouri*); ii) the north Queensland tiger prawn sector, which mainly targets brown tiger prawns (*P. esculentus*) and grooved tiger prawns (*Penaeus semisulcatus*); iii) the scallop sector, which mainly targets *Amusium balloti*; iv) the shallow water (< 50 fathoms) eastern king prawn sector; and v) the deep water (> 50 fathoms) eastern king prawn sector, which target *Penaeus plebejus*. We also examined the differences in relative fishing power increases between sectors, in terms of the technological influences, and suggest possible explanations for these differences.

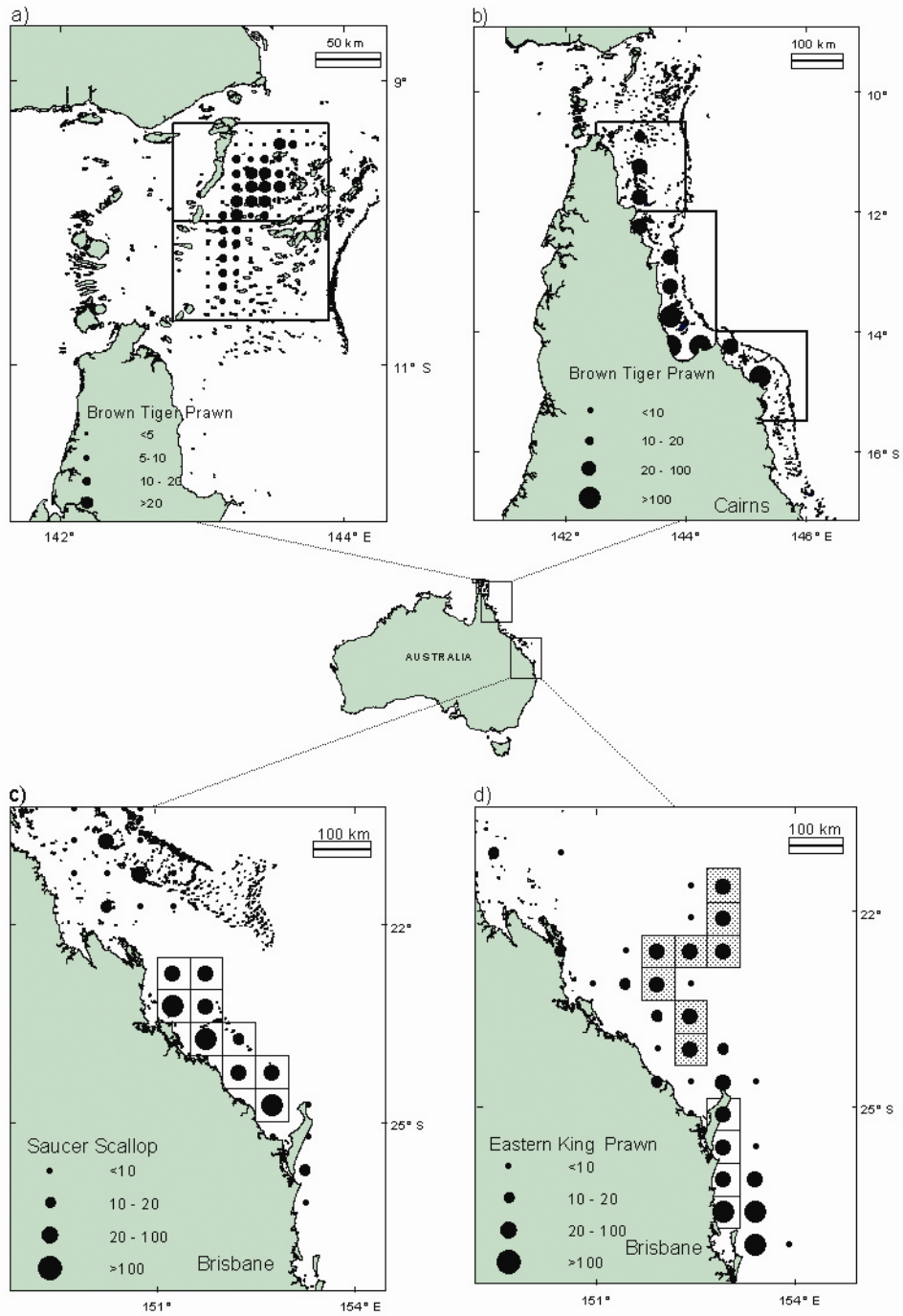

Figure 6.2.1 The spatial distribution of average annual catch (tonnes) from each otter trawl sector, for a) the Torres Strait tiger prawns, b) the north Queensland tiger prawns, c) the Queensland saucer scallops and d) the Queensland eastern king prawns; clear grids represent the shallow water (< 50 fathoms) sector, shaded grids represent the deep water (> 50 fathoms) sector. Only data within the grids illustrated were used in the analysis.

6.3 MATERIALS AND METHODS

6.3.1 *Catch Data*

The analyses were based on logbook catch and effort data from each sector over 11 years from 1989 to 1999 (see Torres Strait note below). The data consisted of the daily catch of each individual vessel. The spatial resolution of catches recorded from the Queensland east coast were based on 30 minute \times 30 minute latitudinal and longitudinal grids and in the Torres Strait were based on 6 \times 6 minute grids. In order to omit the less reliable data, only data from vessels that had fished on more than four days in any month were used in the analyses, similar to the criterion used by Robins et al. (1998) and Bishop et al. (2000). The two tiger prawn sectors' catch is based upon more than one main target species. To remove the effect of non-directed fishing in these sectors, only tiger prawn catches greater than 20 kilograms per day were used. Note that Torres Strait tiger prawn fishing power increases were re-estimated in the final stages of this project. The updated Torres Strait analysis used catches from 1982 to 2000. The data exclusion rules of less than 20 kilograms of tiger prawns and vessels fishing less than five days in any month were not imposed. The results were similar to the original analysis for the years 1989 to 1999.

6.3.2 *Fishing gear and technology data*

The analysis considered a number of different vessel characteristics thought to affect fishing power. Data on the historical development and adoption of vessel/fishing technologies were collected through personal interviews of vessel owners or skippers. Interviews were completed for 344 past and present operating vessels, selected randomly from the entire trawl fleet of 900 vessels that had fished during 1997 and 1998. The 344 vessels represented a response rate of 85% of the 406 vessel operators who were contacted. Overall, the sample included vessels that collectively accounted for about 40% of each sector's total catch between 1989 and 1999. Vessel owners or skippers were asked to provide written records of vessel characteristics for the interview. Changes in the following characteristics and the date of each change were recorded for each vessel.

- Skippers (owner operated, relative of owner, or non-relative)
- Vessel length, engine power (HP), average trawl speed (knots), fuel capacity (litres), propeller size (inches) and the presence or absence of a propeller nozzle.
- Navigation equipment (presence or absence of global positioning systems (GPS) and plotters, and computer mapping software).
- The presence or absence of try-gear [try-gear is a small (1–3 fathom) net used for frequent 10-20 minute sampling of trawl grounds].
- The use of bycatch reduction devices (presence or absence).
- Trawl net configurations:
 1. Number of nets (single, double, triple, quad or five nets).
 2. Total net head rope length (fathoms) combined for all nets.
 3. Net mesh size (mm).
 4. Type of ground chain (fixed drop chain, drop chain with sliding rings, drop rope and chain combined, looped chain or other less common configurations) and chain size (mm).
 5. Type of otter board (Bison, Flat, Kilfoil, Louvre or other less common types) and size (total board area = board length \times width).

6.3.3 Statistical analysis

The analysis used a general linear model with normally distributed errors on the log scale. The response variable was based on individual vessel catches, summed over a unit of time for a spatial area. Therefore, throughout this paper we report on changes in fishing power affecting the catch. However, because fishing effort is included in our analysis as an explanatory variable, the findings are pertinent to both catch and catch rates.

Since catches of adult eastern king prawns are known to vary markedly with lunar phase (Courtney et al., 1996), it was suspected that catches of the other prawn species and possibly scallops may also vary with lunar phase. Lunar phase was therefore considered as the most suitable unit of time. Four lunar phases were defined: 1) new moon (± 3 days), 2) half moon rising to full moon (± 3 days), 3) full moon (± 3 days) and 4) half moon falling to a new moon (± 3 days).

Statistical areas within each sector were defined for the analysis to account for spatial variation in prawn and scallop abundance. For the eastern king prawn and scallop analyses the 30×30 minute spatial logbook catch grids were used (Figure 6.2.1c and d). For the tiger prawn analyses, larger spatial areas were used (Figure 6.2.1a and b). The data for the Torres Strait tiger prawn sector were stratified into two areas, north and south of 10°S on the basis of species composition of the catch, the average catch rates of tiger prawns and fishing effort. This stratification roughly divided the Torres Strait fishery in half. Catch and catch rates of tiger prawns tended to be higher in the northern area (Figure 6.2.1a). The Queensland east coast tiger prawn sector north of $15^\circ 30'\text{S}$ was divided into three areas: north, middle and south on the basis of species composition (Figure 6.2.1b).

Fishing years, rather than calendar years, were defined for each sector and used for the analyses. A fishing year was a 12-month period, the first month of which was the month when recruitment to the fishery typically occurred. Thus, fishing years were November to October inclusive for the eastern king prawn and saucer scallop sectors and March to February inclusive for tiger prawn sectors.

The final model considered the number of days that the vessel fished during the lunar phase period for a spatial area, the vessel's gear characteristics at that time, fishing year, and calendar month as explanatory variables. Each sector was analysed separately. Catches were predicted according to the catch-biomass relationship defined by Hilborn and Walters (1992)

$$C_{vayml} = B_{ayml} E_{vayml} q_{vayml} \quad (1)$$

where C_{vayml} was the catch of the v th vessel in area a , during fishing year y , month m and lunar phase l . B_{ayml} was the biomass or abundance term for prawns or scallops in each trawl sector, E_{vayml} was the number of days fished, and q_{vayml} was the measure of prawn or scallop catchability. The logarithm of the relationship (Equation 1) reduced to an additive form (Equation 2), rather than the original multiplicative form, and was defined in a linear model as

$$\log(C_{vayml}) = \beta_0 + \beta_1 + \beta_2 \log(E_{vayml}) + \beta_3 + \varepsilon \quad (2)$$

where β_0 and β_2 are scalar parameters to be estimated, β_1 and β_3 are vector parameters to be estimated, and ε is the $NID(0, \sigma^2)$ error term. The biomass terms, β_1 which relate to changes in $\log(B_{ayml})$, was expressed by the interaction effects of different variables that influence prawn or scallop abundance (β_1) including fishing areas, fishing years, months and lunar phases; these variables were labelled and described together as biotic factors. The catchability of prawns and scallops in each sector, $\beta_3 \approx \log(q_{vayml})$, is represented by a vector of capture system (catchability) variables (β_3) including different skippers, vessel characteristics, navigation equipment, trawl gear, bycatch reduction devices and trawl net configurations; these variables were labelled and described together as the abiotic effects. This component of the model is the exclusive focus of interpretation in this chapter. The results of the biotic vector (β_1) are not discussed herein.

The statistical software package Genstat 5 (2000) was used to carry out the analysis and provide asymptotic standard errors for all estimates. Stepwise regression was used to select optimal model parameters ($p < 0.05$). The analysis of residuals from each linear model fit supported the use of the normal residual distribution on the log scale (Appendix 15.2).

6.3.4 Estimating relative fishing power

All statistically significant parameter estimates (β_3) from the GLM were used to calculate yearly changes in the average relative fishing power for each sector (Table 6.4.1). Three steps were used to combine the catchability coefficients (β_3) to express relative fishing power in each fishing year as a percentage change relative to the first fishing year considered, which was 1980 for Torres Strait tiger prawns and 1989 for the other trawl sectors. The first step (Equation 3) used the product of the continuous covariate parameters in β_3 , and the difference d_{yi} between the average logarithm value for each covariate in each fishing year and the average logarithm covariate value for the first fishing year, for example y_{1989} . The logarithm averages were calculated from the GLM data and weighted by the number of days fished by each vessel, so as to reflect the make up of fishing effort in each sector and fishing year.

$$f_{yi} = \beta_{3i} d_{yi} \quad (3)$$

where f_{yi} was the relative fishing power component in fishing year y for covariate effect i in β_3 .

The second step (Equation 4) estimated the relative fishing power component for the different categorical covariates (or factors) i and their levels j in β_3 .

$$f_{yi} = \sum_{j=1}^n \beta_{3ij} p_{yij} - \sum_{j=1}^n \beta_{3ij} p_{y_{1989}ij} \quad (4)$$

where p_{yij} were the corresponding proportions of days of fishing effort in the different covariate level categories during year y ; for Torres Strait tiger prawns y_{1980} substitutes for y_{1989} .

The final step (Equation 5) combined both the continuous and categorical covariate components across the different fishing years y and catchability parameters i to

represent the relative fishing power as a percentage of first fishing year 1989 or 1980. This approach effectively used the parameter estimates β_3 to calculate the proportional differences in catch rates for annual changes in covariates and factor levels (similarly described in Robins et al 1998).

$$F_y = 100 \times \left(\prod_i e^{f_{yi}} - 1 \right) \quad (5)$$

6.4 RESULTS

6.4.1 Summary of fishing gears and technologies

Figure 6.4.1 provides a summary of the changes in fishing vessels, gears and technologies from 1989 to 1999. Figure 6.4.2 provides an extra summary of the changes in Torres Strait fishing vessels from 1980 to 2002. The maximum allowable size of vessels in all trawl sectors throughout this period was, and remains at, 20 metres. The average length of vessels remained unchanged and larger vessels generally operated in the Torres Strait and deep-water eastern king prawn sectors (Figure 6.4.1a). The size of nets used in each sector remained relatively constant (Figure 6.4.1k). Generally, fishing vessels used the maximum amount of net permissible in the tiger prawn and shallow water eastern king prawn sectors (24 fathoms head rope length), and in the saucer scallop sector (30 fathoms of headrope). Although the maximum amount of net used in the deepwater eastern king prawn sector is 50 fathoms of head rope length, the average length of nets used was only about 40 fathoms. This may be due to restrictions on vessel size and engine power preventing vessels from effectively towing 50 fathoms of net.

In contrast to the relative consistencies in average vessel and net size, there have been some significant changes that may affect the swept area capacity of vessels within each sector. For example, although restricted to 400 HP there were substantial increases in engine size across all sectors (Figure 6.4.1b). Interestingly, only minor increases in average trawl speed occurred over the same period (Figure 6.4.1c). The adoption of GPS increased markedly from 1988 and by 1992 the majority of fishing effort expended in the fishery was with the aid of GPS (Figure 6.4.1h). The use of computers with advanced mapping software, such as CPLOT™, to display and precisely record the GPS latitudinal and longitudinal positions on detailed coastal maps began around 1994 (Figure 6.4.1i). By the 1999 fishing season, about 90% of the Torres Strait tiger prawn, 65% of the north Queensland tiger prawn, 40% of the eastern king prawn and of the scallop fleets were using computer-mapping software. Other significant changes that have occurred include higher gear box ratios (Figure 6.4.1d), greater use of propeller nozzles (Figure 6.4.1e), larger vessel fuel capacities (Figure 6.4.1f), greater use of try gear in the eastern king prawn and scallop sectors (Figure 6.4.1g), and the gradual adoption of by-catch reduction and turtle exclusion devices (Figure 6.4.1j). In the tiger prawn sectors, there has been a significant change away from using standard flat otter-boards to other board types such as Bison, Louvre and Kilfoil (Figure 6.4.1l).

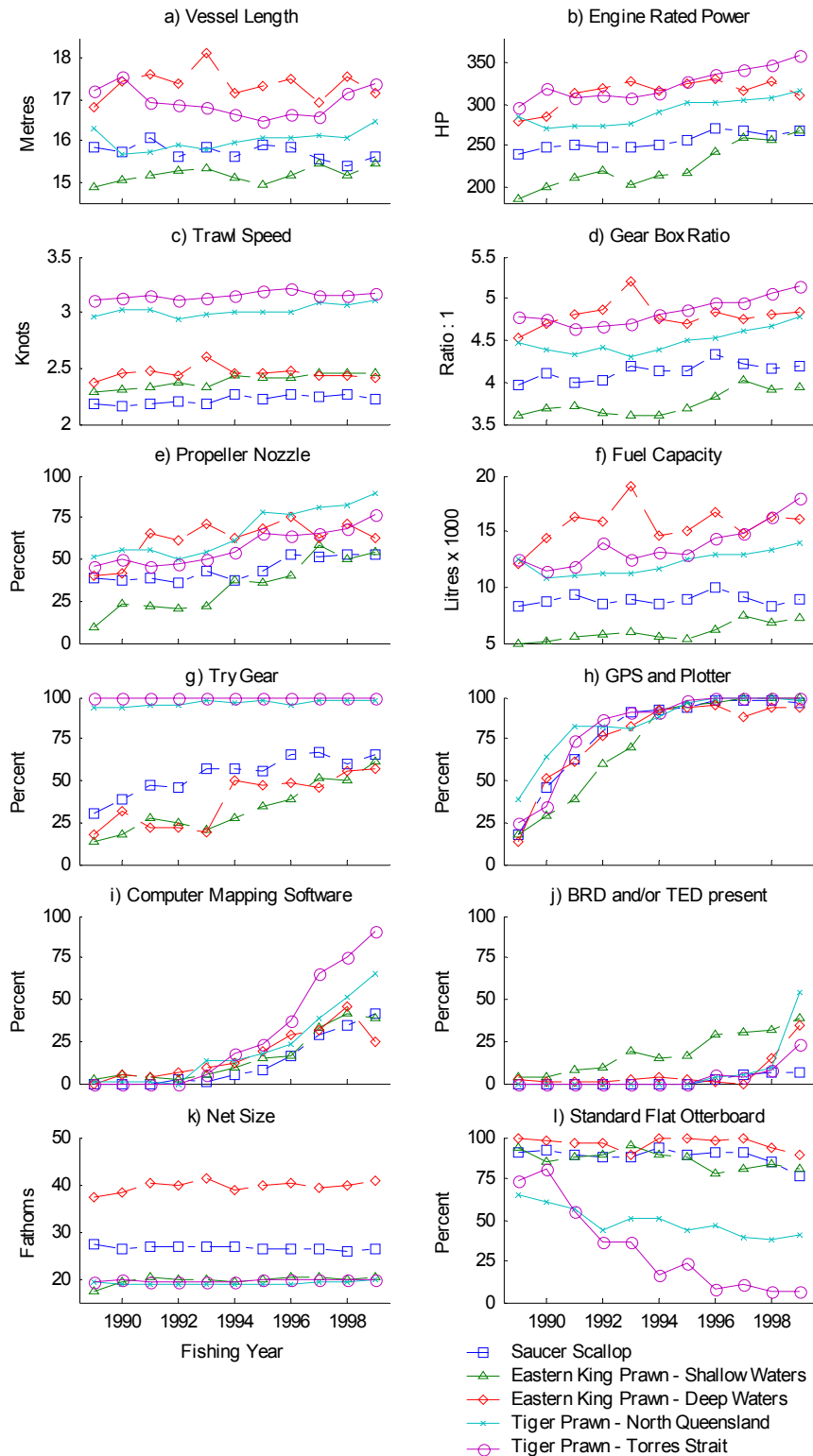

Figure 6.4.1 Summary of average fleet characteristics by fishing year and trawl sector. Plots a, b, c, d, e, f and k are weighted means according to the number of days fished by each vessel in each fishing year and sector. Plots g, h, i, j and l represent the percent of fishing effort (boat days) in each fishing year and sector using that particular device.

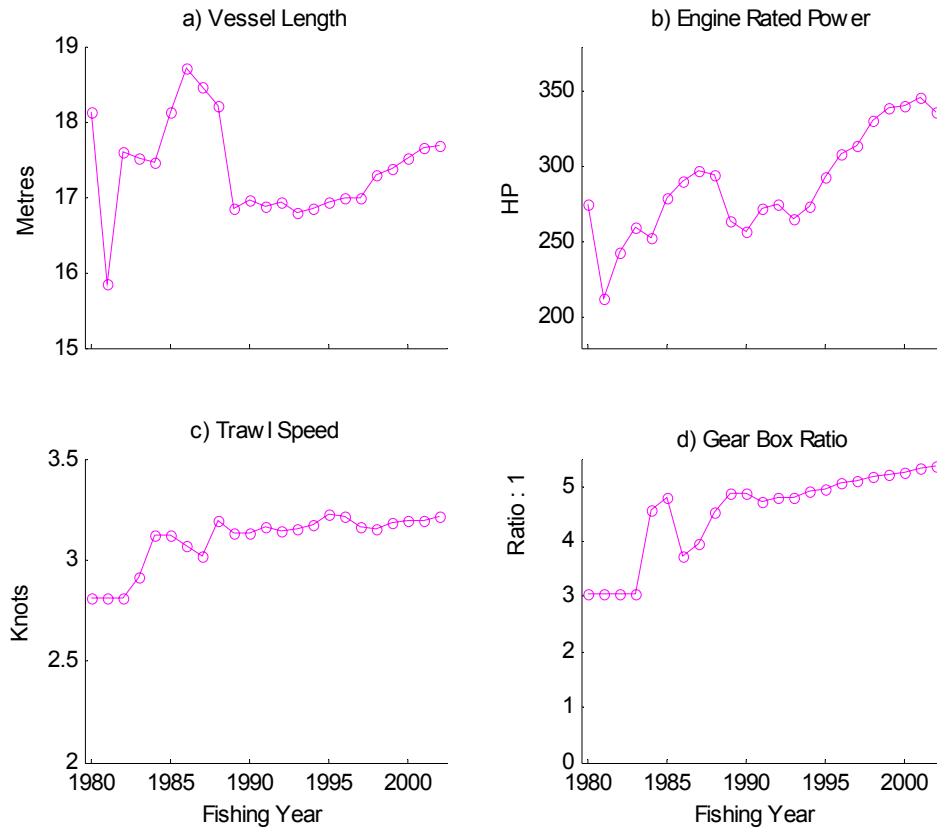

Figure 6.4.2 Summary of Torres Strait tiger prawn average fleet characteristics from 1980 to 2002. The plots are weighted means according to the number of days fished by each vessel in each fishing year. Note low vessel numbers for gear box ratio prior to 1988.

6.4.2 Analysis of prawn and scallop catches

Table 6.4.1 and Table 6.4.2 contain the regression parameter estimates for fishing effort, and the various gears and technologies for the five sectors. For each sector, fishing effort was the most significant variable influencing catch. Parameter estimates for fishing effort were all significantly greater than 1 ($p < 0.05$), which suggests that vessels fish longer in areas where catches are higher (i.e. the ratio between catch and a day of effort is not 1:1).

A number of positive effects on catch were identified in each sector. For both tiger prawn sectors, engine horsepower, trawl speed, gearbox ratio, propeller nozzle, global positioning systems, computer mapping software and sonar usage had a significant positive effect on catch. In the shallow water eastern king prawn sector, vessel length, engine horsepower, bycatch reduction devices (BRD) and turtle exclusion devices (TED) had significant positive effects. In the deep-water eastern king prawn sector, the use of propeller nozzles, vessel fuel capacity, BRD and TED use, and net size (total head rope length) had a positive affect. In the scallop sector, engine horsepower, propeller size, try-gear, BRD and TED use, and ground chain size had a positive effect on catch.

The effect of some technologies and gears on catches differed across sectors. For example, in the eastern king prawn and scallop sectors, vessels that used BRD or TED

devices generally had a 6% to 11% higher average catch compared with vessels without these devices. In contrast however, average catches were generally about 4% to 7% lower for vessels using BRDs or TEDs in the Torres Strait tiger prawn sector. Navigation technologies including GPS, computer mapping software, and sonar were only significant in the Torres Strait and north Queensland tiger prawn sectors. In these sectors, the use of GPS and plotter resulted in 4% and 8%, computer-mapping software 4% and 12%, and sonar 7% and 13% higher average catches of tiger prawns in the north Queensland and Torres Strait sectors respectively. The Torres Strait parameter estimates (Table 6.4.1 and Table 6.4.2) were very similar to those estimated by Robins et al. (1998), GPS (4%), GPS and plotter (7%) and Bishop et al. (2000), GPS (5%) and propeller nozzle (7%).

For all five-trawl sectors analysed there was no evidence of highly correlated gear and technology (β_3) parameters. Table 6.4.3 lists the parameter correlations greater than 0.3. These correlations were only moderate and generally involved highly significant parameters ($p < 0.01$). After identifying these correlations, removing any of these parameters from the analysis had little effect in the sense that the inferences on remaining parameters were unchanged. In addition, removing any of the listed correlations from the analysis resulted in little change from the overall average fishing power estimates (next section), suggesting that the correlations listed in Table 6.4.3 were not of a significant magnitude.

Table 6.4.1 Parameter estimates (β_2 and β_3) and standard errors in parenthesis from the general linear model analysis (natural log transformed), for each trawl sector 1989 to 1999. The bold parameters indicate the most important covariate effects on fishing power. NS indicates the parameter was not significant and excluded from the analysis ($p > 0.05$). * indicates the gear type was grouped under other less used types.

Summary of Analysis	Eastern King Prawn (Shallow)	Eastern King Prawn (Deep)	Tiger Prawn North Queensland	Tiger Prawn Torres Strait	Saucer Scallop
Regression Mean Square	48.785	21.960	102.371	87.633	59.050
Residual Mean Square	0.945	0.319	0.745	0.541	0.578
Regression df, Residual df	320, 7192	420, 4216	269, 10867	204, 7083	455, 14011
R ²	68.3	86.0	76.7	81.9	76.1
Parameter estimates					
Fishing Effort (days)	1.161 (0.013)	1.147 (0.009)	1.070 (0.008)	1.082 (0.009)	1.150 (0.007)
Vessel length	0.707 (0.110)	-0.548 (0.139)	-0.213 (0.059)	0.163 (0.073)	NS
HP	0.496 (0.046)	-0.142 (0.041)	NS	0.146 (0.049)	0.146 (0.022)
Trawl speed	-0.468 (0.076)	-0.334 (0.072)	NS	0.209 (0.058)	-0.083 (0.026)
Gear box ratio	-0.993 (0.055)	-0.172 (0.062)	0.192 (0.036)	0.210 (0.045)	NS
Propeller size	NS	NS	NS	NS	0.416 (0.036)
Propeller nozzle (present)	-0.055 (0.022)	0.044 (0.021)	0.053 (0.010)	0.081 (0.018)	NS
Fuel capacity	NS	0.108 (0.024)	0.149 (0.014)	NS	NS
Skipper type (4 levels)					
Mixed	0	0	0	0	0
Non-related to owner	0.124 (0.056)	-0.146 (0.033)	-0.121 (0.022)	0.069 (0.021)	0.068 (0.030)
Owner operated	0.021 (0.051)	-0.094 (0.034)	-0.090 (0.022)	0.059 (0.023)	0.102 (0.029)
Related to owner	-0.246 (0.056)	-0.102 (0.036)	0.020 (0.025)	0.125 (0.028)	0.1223 (0.030)
Try gear (present)	-0.109 (0.024)	NS	NS	NS	0.154 (0.010)
GPS	NS	NS			NS
Absent			0	0	
GPS and Plotter			0.040 (0.015)	0.075 (0.023)	
Computer Mapping	NS	NS	0.037 (0.012)	0.092 (0.014)	NS
Sonar	NS	NS	0.100 (0.014)	0.118 (0.013)	NS
BRD and/or TED (present)	0.070 (0.022)	0.058 (0.031)	NS	-0.074 (0.018)	0.100 (0.028)
Trawl gear – number of nets		NS	NS		NS
Single	0.293 (0.094)				
Double	0			0	
Triple	0.148 (0.049)			-0.277 (0.040)	
Quad	0.754 (0.057)			-0.004 (0.029)	
Five	0.359 (0.079)				
Net size – for all nets combined	NS	0.381 (0.070)	NS	-0.575 (0.111)	0.065 (0.037)
Mesh size	-0.474 (0.089)	NS	-0.524 (0.196)	NS	-0.323 (0.053)
Ground gear				NS	
Drop chain	0	0	0		0
Drop chain with sliding rings	0.003 (0.036)	-0.008 (0.028)	-0.025 (0.030)		0.055 (0.012)
Looped chain	-0.220 (0.027)	-0.051 (0.024)	*		0.065 (0.012)
Drop rope and chain	-0.091 (0.023)	0.078 (0.022)	0.052 (0.037)		*
Others less used types	-0.334 (0.025)	0.046 (0.025)	0.208 (0.037)		0.187 (0.020)
Ground gear – chain size	0.525 (0.100)	NS	-0.095 (0.044)	0.265 (0.057)	0.089 (0.040)
Otter boards			NS		
Others less used types	0	0		0	0
Bison	*	*		-1.083 (0.606)	0.784 (0.362)
Louvre	*	*		-2.434 (0.720)	0.754 (0.283)
Standard flat	-1.894 (0.275)	3.131 (0.993)		-0.609 (0.674)	0.244 (0.260)
Kilfoil	*	*		-1.593 (0.652)	-3.112 (0.724)
Otter board size (length*height)					
Other less used types	-0.132 (0.076)	1.939 (0.325)	0.022 (0.031)	-0.452 (0.213)	0.209 (0.086)
Bison board size	*	*	0.088 (0.033)	-0.051 (0.045)	-0.033 (0.089)
Louvre board size	*	*	0.057 (0.029)	0.384 (0.099)	-0.044 (0.044)
Standard flat board size	0.486 (0.056)	1.015 (0.132)	0.077 (0.028)	-0.177 (0.082)	0.1374 (0.034)
Kilfoil board size	*	*	0.050 (0.028)	0.121 (0.062)	1.157 (0.217)

Table 6.4.2 Parameter estimates (β_2 and β_3) and standard errors in parenthesis from the general linear model analysis (natural log transformed), for the Torres Strait tiger prawn sector 1982 to 2000 (updated analysis). The bold parameters indicate the most important covariate effects on fishing power. Additional parameters not reported were either non-significant ($p>0.05$) or correlated with those already in the model below.

Summary of Analysis	Tiger Prawn Torres Strait
Regression Mean Square	30.105
Residual Mean Square	0.165
Regression df, Residual df	292, 9643
R ²	84.2
Parameter estimates	
Fishing Effort (days)	1.10199 (0.00647)
HP	0.1197 (0.0335)
Trawl speed	-0.1 (0.0526)
Gear box ratio	0.2639 (0.0336)
Skipper type (4 levels)	
Owner operated	0
Related to owner	0.1192 (0.0145)
Non-related to owner	0.0024 (0.0111)
Mixed	-0.0145 (0.0257)
GPS	
Absent	0
GPS and Plotter	0.0681 (0.021)
Computer Mapping	0.1118 (0.0125)
Sonar	0.0699 (0.0103)
BRD and/or TED (present)	-0.0441 (0.0183)
Trawl gear – number of nets	
Double	0
Triple	-0.2878 (0.036)
Quad	0.0228 (0.0241)
Ground gear – chain size	0.3037 (0.0529)
Otter boards	
Bison	0
Louvre	-0.0385 (0.0134)
Standard flat	-0.0076 (0.0129)
Kilfoil	-0.0117 (0.014)
Others less used types	-0.0753 (0.0291)

Table 6.4.3 General linear model β_3 parameter correlations between the different vessel characteristics, for each trawl sector. Correlations larger than 0.3 are listed.

Parameter estimates	Parameter Correlations
Eastern King Prawn (Shallow)	
Trawl speed and Propeller nozzle	-0.355
Gear box ratio and Skipper (Non-related to owner)	-0.348
Trawl gear (Triple nets) and Standard flat board	0.351
Eastern King Prawn (Deep)	
Ground gear (Drop chain with sliding rings) and Net size	-0.523
Ground gear (Looped chain) and Skipper (Owner operated)	0.314
Fuel capacity and Propeller Nozzle	-0.444
Gear box ratio and Skipper (Related to owner)	0.408
Gear box ratio and Ground gear (Looped chain)	0.514
Gear box ratio and Fuel capacity	-0.451
HP and Ground gear (Drop rope and chain)	-0.319
Otter board size (Standard flat) and Net size	-0.508
Otter board size (Standard flat) and Vessel length	-0.391
Otter board size (Standard flat) and Gear box ratio	-0.324
Otter board size (Standard flat) and HP	-0.346
Tiger Prawn North Queensland	
Ground gear chain size and Otter board size (Others types)	-0.386
Ground gear chain size and Otter board size (Bison)	-0.453
Ground gear chain size and Otter board size (Lourve)	-0.468
Ground gear chain size and Otter board size (Standard flat)	-0.475
Ground gear chain size and Otter board size (Kilfoil)	-0.471
Vessel length – Fuel capacity	-0.436
Gear box ratio and Fuel capacity	-0.402
Ground gear (Drop chain with sliding rings) and Mesh size	0.429
Tiger Prawn Torres Strait (1989–1999 analysis)	
Net size and HP	-0.497
Ground gear chain size and Vessel length	-0.385
Ground gear chain size and GPS	0.361
Otter board size (Bison) and Trawl gear (Triple nets)	0.575
Otter board size (Bison) and Trawl gear (Quad nets)	0.435
Tiger Prawn Torres Strait (1982–2000 analysis)	
HP and Ground gear chain size	-0.391
Trawl gear (Quad nets) and Otter board type (Standard flat)	-0.314
Ground gear chain size and Otter board type (Standard flat)	0.354
Saucer Scallop	
Propeller size and HP	-0.42
Mesh size and Ground gear (Drop chain with sliding rings)	0.304
Standard flat board and Net size	-0.445

6.4.3 Estimates of Fishing Power

Estimated increases in average relative fishing power were higher in the shallow water eastern king prawn and Torres Strait tiger prawn sectors compared with the other sectors (Table 6.4.4 and Table 6.4.5). For the 11-fishing year period 1989 to 1999 average relative fishing power increased by 27% and 16% in the shallow water eastern king prawn and Torres Strait tiger prawn trawl sectors respectively. Increases in average relative fishing power was comparatively small (less than 6%) for the deep-water eastern king prawn, north Queensland tiger prawn and saucer scallop sectors. Torres Strait tiger prawn fishing power increases were compared using the parameters estimated in Table 6.4.1 (using data from the fishing years 1989 to 1999) to the parameters estimated using the longer time series of data from 1982 to 2002 (Figure 6.4.3). The estimated fishing power increases were quite similar. Figure 6.4.4 compares average annual catch rates calculated from the observed data with the fishing power standardised values. Although average annual catch rates showed considerable between-year variation for each fishing sector, the standardised catch rates tended to show a slight long-term decline.

Table 6.4.4 Percent change in average fishing power from 1989 to 1999 (95% confidence intervals shown in parentheses), for the shallow water (< 50 fm depth) eastern king prawn, the deep water (> 50 fm depth) eastern king prawn, the north Queensland tiger prawn and the saucer scallop trawl sectors. Note the percent change represents the difference from the base reference year 1989, which was set at 0. The significance of changes in fishing power should be compared between all years, not just 1989. The fishing years represent the period from November through to October for the eastern king prawn and saucer scallop sectors, and March through to February for the tiger prawn sectors.

Fishing Year	Eastern King Prawn (Shallow)	Eastern King Prawn (Deep)	Tiger Prawn North Queensland	Saucer Scallop
1989	0	0	0	0
1990	7.4 (-3.4, 18.6)	2.3 (-0.4, 5.0)	-2.2 (-3.5, -0.8)	0.3 (-3.1, 3.6)
1991	16.5 (9.7, 23.5)	3.2 (-1.6, 8.0)	-2.2 (-4.6, 0.2)	1.9 (-1.6, 5.4)
1992	18.5 (13.3, 23.8)	5.7 (1.8, 9.7)	-2.7 (-6.8, 1.4)	2.0 (-0.5, 4.5)
1993	14.1 (9.9, 18.2)	6.2 (0.4, 12.3)	-1.9 (-5.7, 1.9)	2.7 (-4.9, 10.2)
1994	8.3 (2.4, 14.2)	2.3 (-5.0, 5.9)	-2.2 (-7.9, 3.4)	2.2 (-4.8, 9.1)
1995	13.5 (6.0, 21.3)	4.3 (0.1, 8.6)	-0.8 (-7.9, 6.4)	1.4 (-2.9, 5.7)
1996	21.7 (9.4, 34.7)	3.7 (-0.6, 8.2)	0.2 (-6.5, 7.0)	4.1 (-2.1, 10.1)
1997	17.4 (5.2, 30.2)	3.7 (-0.4, 7.9)	1.9 (-6.3, 10.1)	4.0 (-0.2, 8.2)
1998	15.9 (4.4, 28.0)	6.1 (0.9, 11.2)	3.1 (-4.4, 10.5)	0.7 (-7.2, 8.4)
1999	26.5 (13.6, 40.2)	5.1 (-0.9, 11.0)	5.5 (-1.7, 12.6)	2.8 (-10.0, 15.4)

Table 6.4.5 Percent change in average fishing power from 1980 to 2002 (95% confidence intervals shown in parentheses), for the Torres Strait tiger prawn trawl sector (using 1982 to 2000 GLM analysis). Note the percent change represents the difference from the base reference year 1980, which was set at 0. The significance of changes in fishing power should be compared between all years, not just 1989. The fishing years represent March through to February for this tiger prawn sector. These estimates are plotted using red lines in Figure 6.4.3

Fishing Year	Tiger Prawn Torres Strait
1980	0 (0, 0)
1981	-2.9 (-4.5, -1.1)
1982	-0.4 (-1.3, 0.5)
1983	0.5 (-0.1, 1)
1984	1.2 (0.4, 2)
1985	7.8 (6.5, 9.2)
1986	1.6 (0.5, 2.7)
1987	3.8 (2.7, 4.9)
1988	8.3 (7.2, 9.5)
1989	8.5 (6.4, 10.6)
1990	11 (8.1, 13.8)
1991	9.6 (5.8, 13.4)
1992	11.6 (7.2, 16.1)
1993	12.9 (8.3, 17.7)
1994	15.6 (10.8, 20.5)
1995	14.2 (9.2, 19.4)
1996	17.7 (12.4, 23.1)
1997	21.5 (15.9, 27.3)
1998	23 (17.2, 29)
1999	24.9 (18.8, 31.2)
2000	26.6 (20.2, 33.5)
2001	25.3 (18.2, 32.8)
2002	23.6 (16, 31.7)

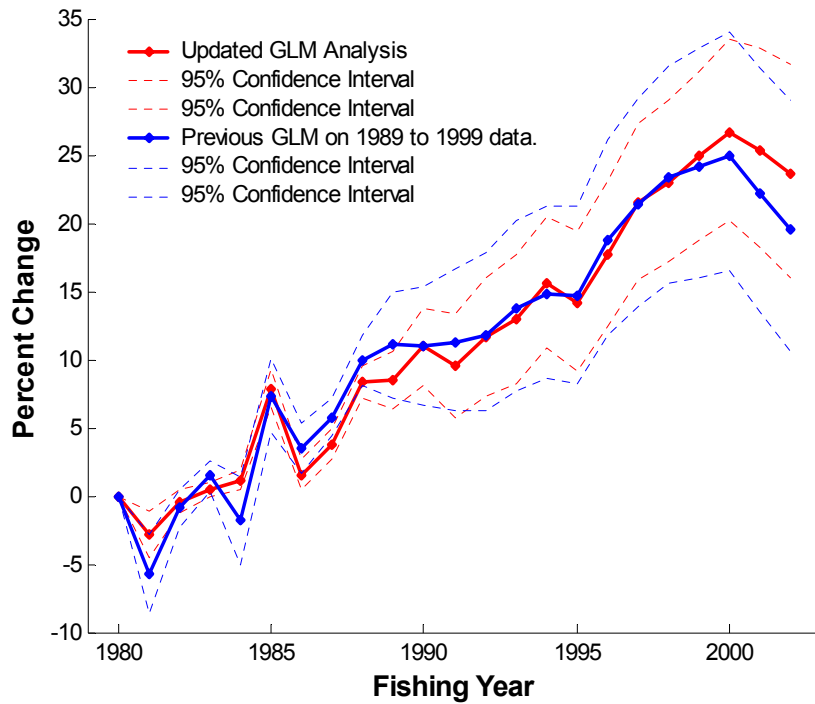

Figure 6.4.3 Comparison of fishing power increases for Torres Strait tiger prawns using generalised linear model parameter estimates from analysing a) 1982 to 2000 catch rates and b) 1989 to 1999 catch rates. Estimates of fishing power increases were not significantly different with overlapping estimates and confidence intervals.

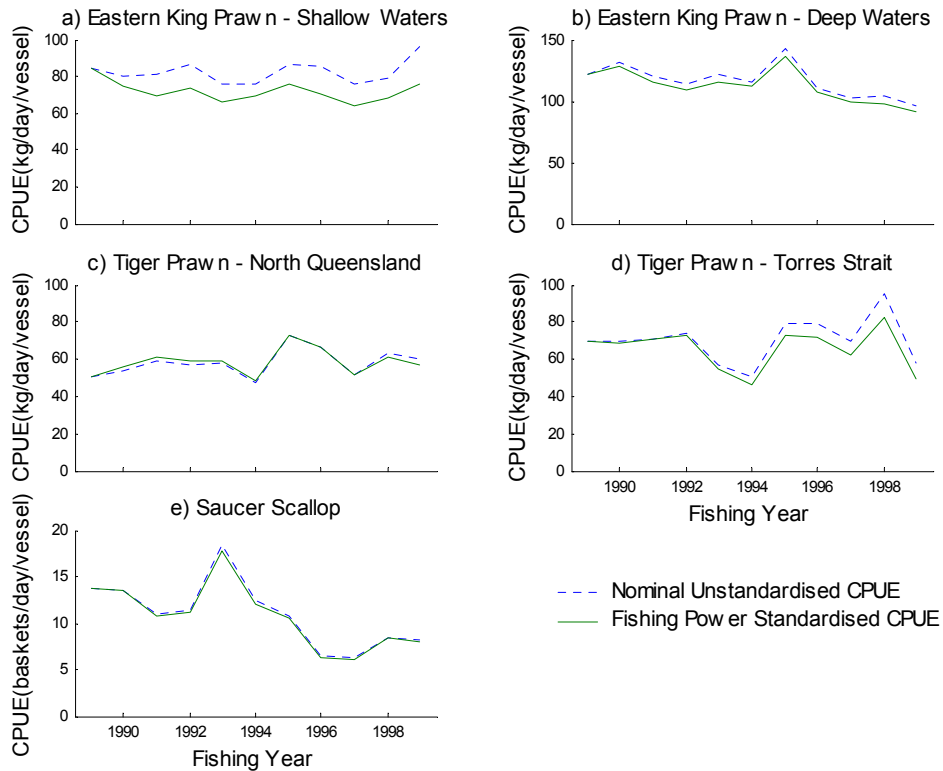

Figure 6.4.4 Comparison of nominal unstandardised (raw data) and fishing power standardised annual average catch rates (CPUE = catch-per-vessel day).

6.5 DISCUSSION

6.5.1 *Fishing power*

The analysis indicated that annual changes in average fishing power differed between the sectors. Fishing power in the shallow water eastern king and Torres Strait tiger prawn sectors had the highest rates of increase, which was not surprising given the large increase in average engine size in both of these sectors (Table 6.4.4 and Table 6.4.5). Increases in the number of vessels using global positioning systems and computer mapping software also contributed to increased fishing power in the two tiger prawn sectors. In the deep-water eastern king prawn sector average fishing power increases were surprisingly low (Table 6.4.4). For this sector it was found that larger nets (net head rope lengths) were associated with larger catches, but management controls, for example over vessel and engine size, may have resulted in indirect limitations to the size of nets that fishers tow, and thus restricted fishing power.

Fishing power increased at a greater rate in the shallower, inshore fisheries (shallow eastern king prawn and tiger prawn sectors), possibly because vessels in these sectors originally had less technological capital investment, and therefore, the greatest potential for technology transfer and improvement in fishing power. Average annual fishing power increases were lowest in the scallop sector (Table 6.4.4). This is at least partially due to the higher catch rates and fishing power in the scallop sector being associated with a relatively low average trawl speed of about 2.2 knots. At speeds greater than this, catch rates of scallops would be expected to decline. This was in marked contrast to the prawn sectors, where higher catches were taken at speeds of at least 3 knots.

A number of important factors affecting catches of prawns and scallops were identified, particularly factors relating to the searching capacity of vessels. The regressions indicated that vessels fish longer in areas where catches are high. The models' parameter estimates for fishing effort were all significantly greater than 1 (Table 6.4.1) and were similar to those reported by Bishop et al. (2000) and Robins et al. (1998). This implies that catch per day of fishing effort does not have a simple interpretation. Catch rates from vessels that undertook short trips were not directly comparable with those from vessels that undertook longer trips. Within a trip, search time is probably important in identifying high catch areas and the vessels that remained longer during trips tended to be those that experienced higher than average catches. Therefore, a more representative average catch rate index for each sector should be estimated by using the number of days fished in each trip as a covariate for prediction from a generalised linear model.

The other interesting result was that some of the technological adoptions did not always relate to higher fishing power and catch (i.e. they resulted in non-positive or negative parameter estimates). This was surprising given the dramatic trends in the technical adoptions, described in Chapter 5 and Figure 6.4.1. Why this is the case is difficult explain other than to state that estimating fishing power is a complex multivariate function and dependent on the range of different vessels fishing. It should be remembered that the results in Table 6.4.1 and Table 6.4.2 are a function of the

vessels fishing in each of the defined sectors. Some parameter coefficients could be viewed as unexpected, but may make sense keeping in mind the range of different vessels fishing each sector. We discuss why certain vessel characteristics and technologies did not increase fishing power in the following paragraphs.

When global positioning systems (GPS) was combined with plotter usage it was found to be significant in two out of the five sectors. Our parameter estimates for GPS and plotters from both tiger prawn sectors (nth Qld and TS) are very similar to those estimated by Robins (1998) and Bishop (2000). However, GPS and plotters had only slight positive effects on catches in the eastern king prawn and scallop sectors, but the effect was not statistically significant. The reasons why no statistically significant effect was apparent in the eastern king prawn and scallop sectors are unknown, but may be due to some unique features of these species and its fishery. For example, eastern king prawns are much more migratory than tiger/endeavour prawns, occur in much greater depths and are generally fished along narrow depth contours. Some of these features may lower the significance of GPS and plotters in this particular fishery. The saucer scallop fishing grounds are much smaller than other sectors and the skill to find patches of scallop are probably less dependent on using GPS.

Figure 6.4.1g shows that fishing with try gear is very common in the two tiger prawn sectors (~90-100%). However, over time there was little change in the proportion of fishing effort with try gear (i.e. consistent high use) and therefore there was no contrast to estimate this gear effect. Even if we assumed a positive or negative effect the fishing power increase would still be zero because the proportion of fishing effort with try gear had not changed. The result does not imply the gear was not important for fishing, as it must be because 90%+ of the sector's effort was with try gear.

The effects of BRDs and TEDs on the catches of target species can be highly variable and it is not uncommon in the scientific literature to find examples of positive effects of BRDs on target species catch rates. Our results have shown that in three of the five sectors examined BRDs and TEDs had positive effects on catches, a negative effect in one sector and no significant effect in another. Examples where BRDs have had a positive effect on catch rates of target species include (Rogers et al., 1997), (Broadhurst and Kennelly 1997) and (Steele et al., 2002). Recent research results published in *Queensland Fisherman* also describe slight increases in the catches of scallops from certain combinations of BRDs (Courtney and Campbell, 2003).

The negative relationship between vessel size and catch in the eastern king (deep) and northern tiger prawn sectors in Queensland were unexpected, but make sense for the size range of vessels fishing in each of the sectors considered. In the deep-water king sector most of the fishing effort is due to vessels 16+ metres in length. So the negative coefficient was a result of comparing catches between large and very large trawlers in Queensland. In the north Queensland tiger prawn sector, 13–16 metre vessels conducted most of the fishing effort. So the negative relationship resulted from smaller vessels having reasonable catch rates compared with the larger vessels; the larger vessels fish more in the Torres Strait and expend less effort in this sector. These coefficients are valid for their data sets, and for the measurement of fishing power change in these two sectors.

One component of fishing power that was not possible to assess was skipper skill. Improved skipper knowledge of fishing over time can increase a vessel's fishing power with no change in equipment. In the analyses we endeavoured to capture some of this effect by allowing for different skipper types. However, to properly quantify the improvement in fisher skill it is necessary to consider the number of years, or the cumulative number of nights that fishers have operated. Another related matter is that low-technology fishing operators may modify their behaviour by observing high-technology operators. The acquisition of new equipment by some operators may benefit all operators, for example by all being better at locating patches of saucer scallops. These issues of improved skipper skill and modified fishing behaviour according to other vessels may cause our calculations of fishing power to be under-estimates. The degree of this under-estimation is unknown. However, to support our analysis, Bishop et al (2004) showed for Australia's Northern Prawn Fishery that if sufficient capture-system-variables (e.g., engine size, net size etc) were included in the analysis (as we have done), the effectiveness of skipper skill was non-significant or minimal. This does not suggest that skipper skill, organisational capacity, sense of fishing location or experience are not important, but rather that if the analysis includes a sufficient number of capture-system-variables then one can have confidence in the analyses to produce robust estimates of standardised catch rates.

6.5.2 *Stock assessment*

Annual landings of prawns and scallops from Queensland and the Torres Strait have been relatively consistent; however, catch rates have varied greatly (Oliver et al., 2001 and Williams, 2002). The effects of standardising average catch rates according to changes in average annual fishing power were quite significant for the shallow water eastern king prawns and Torres Strait tiger prawns (Figure 6.4.4a and Figure 6.4.4d). The resulting average standardised catch rates tended to show slight declines compared with the observed nominal average catch rates. The effect of standardisation of average catch rates on stock assessments for each of these sectors will be quite important. Wang and Die (1996) reported that equilibrium yield estimates for the tiger prawns *P. esculentus* in the northern prawn fishery (NPF) were very sensitive to the rate of increase in fishing power. If the rate of annual increase in fishing power in this *P. esculentus* fishery was 2%, maximum sustainable yield would be 2200 tonnes. In comparison, if the annual increase in fishing power were 5%, maximum sustainable yield would be about 1800 tonnes. Even though some of our estimates of increases in fishing power were quite low, their influence on estimates of reference points such as fishing effort at maximum sustainable yield (E_{MSY}) should be examined closely.

6.5.3 *Statistical comments*

In this chapter general linear models were used to analyse prawn and scallop catches. The data were essentially observational as each sector's catch was a result of many factors affecting the swept area of the trawl gear, different fishing strategies between vessels, the searching ability of vessels to identify high catch rate areas and other influences from a range of unknown factors. These data differ from experimental data where the effects of particular fishing gears and technologies on fishing power may be quantified by systematically comparing catches with different devices. The method used here of using vessel and gear technology data to measure changes in average relative fishing power has been used by Hilborn and Walters (1992) and Robins et al. (1998). One criticism of this approach is that

catches from the same vessels fishing in different areas and times are likely to be correlated. This can lead to correlations in the model error structure that may lead to incorrect inferences (due to biased parameter estimates or over- or underestimated standard errors). Whether any of these will occur, or in which direction, can be difficult to predict in advance, because they depend on the patterns of correlations that occur in the data. In light of this, Bishop et al. (2000) investigated the use of generalised estimating equations (GEE) to allow for the effects of these correlations on parameter and variance estimation in data from a similar prawn trawl fishery, but the gains in accuracy over the generalised linear model fit were marginal. The maximum level of bias they reported was twice the 'model-based' standard error. The majority of our parameter estimates would still be significant if this bias was applied. However, Bishop (pers. comm.) recently employed daily data in her models that show little correlation. The temporal unit used in the study was lunar period (approximately seven days) and as such correlations may be less than those of Bishop et al. (2000).

6.5.4 Conclusion

In summary, this study has shown that trawl fishing power on the Queensland east coast has increased by 4%–27%, depending on the sector, over the last 11 years. Monitoring of fishing power and the standardisation of average catches is an essential task, as trawl operators will always improve their ability to catch and reduce operating costs. Even with ongoing monitoring of fishing power, it is often not possible to determine when effective changes have been made in the fishery until after the event. However, with the recent introduction of satellite vessel monitoring systems (VMS) and electronic catch and effort reporting systems (ECERS), catches will be analysed in real-time together with information on vessel and trawl gear specifications. This will enable up to date stock assessments to be provided to managers and more responsive decisions made on managing the trawl fisheries. This is especially important since the Queensland Trawl Fishery is managed on the basis of inputs, such as limiting fishing days, and changes in fishing power need to be monitored in real-time.

6.6 FURTHER DEVELOPMENT

The current estimates of annual increases in fishing power and standardisation of fishing effort used data for all vessels for which there was vessel and gear information. In the years prior to 1989 the number of vessels for which there were vessel and gear information reduced the further back in time. The historical vessel characteristics database, created by this project, should be continually built upon (for vessels fishing prior to 1999 and after). This database should be updated annually through logbook gears sheets and questionnaires completed face-to-face with vessel owners and skippers (the last vessel and gear survey was completed in 1999/2000). It is of high importance to keep this database up to date, and to build upon the historical information in order to calculate standardised catch rates for input into the stock assessments.

6.7 ACKNOWLEDGMENTS

This study was funded by the Fisheries Research and Development Corporation (FRDC 1999/120) and would not have been possible without the efforts of many

people. Special thanks go to the trawler owners and skippers who provided details on their fishing gears and technologies used in the analysis, and to David Mayer for his statistical input into this research. Thanks also go to all staff from the Queensland Department of Primary Industries and Fisheries who provided assistance to the survey. Janet Bishop, David Mayer and Mike Dredge made constructive comments on earlier versions of this chapter. Finally, thanks are due to the referees from the Journal *Fisheries Research*. They provided many helpful suggestions that have improved the presentation. This work was submitted to the Life Histories, Assessment and Management of Crustacean Fisheries Conference organised by EDFAM in A Coruna, Spain, October 2001. The proceedings are published in Volume 65 (2003) of *Fisheries Research*.

6.8 REFERENCES

- Baelde, P. (1991) Assessment of the Australian deep-water royal red prawn stock using commercial catch and effort data. *Fish. Res.* **12**, 243–258.
- Bishop, J., Die, D., Wang, Y. (2000) A generalised estimating equations approach for analysis of the impact of new technology on a trawl fishery. *Aust. N.Z. J. Statist.* **42(2)**, 159–177.
- Bishop, J., Venables, W.N., Wang, Y. (2004) Analysing commercial catch and effort data from a Penaeid trawl fishery. A comparison of linear models, mixed models, and generalised estimating equations approaches. *Fish. Res.* **70**, no. 2–3, 179–193.
- Broadhurst, M.K., Kennelly, S.J. (1997) The composite square-mesh panel: a modification to codends for reducing unwanted bycatch and increasing catches of prawns throughout the New South Wales oceanic prawn-trawl fishery. *Fishery Bulletin* **95**, 653–664.
- Brunenmeister, S.L., (1984) Standardization of fishing effort and production models for brown, white and pink shrimp stocks fished in US waters of the Gulf of Mexico. In: Gulland, J.A., Rothschild B.J. (Eds), *Penaeid shrimps — their biology and management*. Fishing News Books Ltd, Surrey, England, pp. 187–211.
- Courtney, A.J., Campbell, M. (2003) DPI studies bycatch in scallop fishery. *Queensland Fisherman* **21**, 39–43.
- Courtney, A.J., Die, D.J., McGilvray, J.G. (1996) Lunar periodicity in catch rate and reproductive condition of adult eastern king prawns, *Penaeus plebejus* in coastal waters of southeast Queensland, Australia. *Mar. Freshwater Res.* **47**, 67–76.
- Genstat 5 (2000) Lawes Agricultural Trust, Rothamsted Experiment Station.
- Glaister, J.P., Pond, P.C., Storey, J.L. (1993) Framework for management for the east coast trawl fishery. Queensland Fish Management Authority.
- Griffin, W.L., Shah, A.K., Nance, J.M. (1997) Estimation of standardized effort in the heterogeneous Gulf of Mexico Shrimp Fleet. *Mar. Fish. Rev.* **59(3)**, 23–33.

- Hall, N.G., Penn, J. W. (1979) Preliminary assessment of effective effort in a two species trawl fishery for Penaeid prawns in Shark Bay, Western Australia. Rapp. P.-v. Réun. Cons. Int. Explor. Mer. **175**, 147–154.
- Hilborn, R., Walters, C.J. (1992) Quantitative Fisheries Stock Assessment: Choice, Dynamics and Uncertainty. Chapman and Hall, New York.
- McCullagh, P., Nelder, J.A. (1989) Generalised Linear Models, Second Edition. Chapman and Hall, London.
- Oliver, S., D'Silva, D., Turnbull, C. (2001) Torres Prawn Handbook 2001. Australian Fisheries Management Authority, Canberra.
- Quinn II, T.J., Deriso, R.B. (1999) Quantitative Fish Dynamics. Oxford University Press, New York.
- Robins, C.M., Wang, Y.-G., Die, D.J. (1998) The impact of global positioning systems and plotters on fishing power in the northern prawn fishery, Australia. Can. J. Fish. Aquat. Sci. **55**, 1645–1651.
- Rogers, D., Rogers, B., de Silva, J., Wright, V. (1997) Effectiveness of four industry-developed bycatch reduction devices in Louisiana's inshore waters. *Fishery Bulletin* **95**, 552–565.
- Salthaug, A., Godø, O.R. (2001) Standardisation of commercial CPUE. Fish. Res. **49**, 271–281.
- Steele, P., Bert, T.M., Johnston, K.H., Levett, S. (2002) Efficiency of bycatch reduction devices in small otter trawls used in the Florida shrimp fishery. *Fishery Bulletin* **100**, 338–350.
- Wang, Y.-G., Die, D. (1996) Stock-Recruitment relationships of the tiger prawns (*Penaeus esculentus* and *Penaeus semisulcatus*) in the Australian Northern Prawn Fishery. Mar. Freshwater Res. **47**, 87–95.
- Williams, L.E. (2002) Queensland's Fisheries Resources Current Condition and Recent Trends 1988–2000. Queensland Department of Primary Industries, Information Series QI02012.

7 OBJECTIVE 3. COMPARE PRESENT MANAGEMENT PLAN REFERENCE POINTS WITH THE ADJUSTED AND UNADJUSTED CATCH-PER-UNIT EFFORT SERIES

7.1 ABSTRACT

The probability of Queensland eastern king prawn, saucer scallop and north Queensland tiger prawn catch-rates falling below Queensland catch rate reference points was calculated using nominal and standardised data. In addition, reference points for the shallow and deep eastern king prawns were tested separately. The catch-rate reference point is defined as 70% of the average catch-per-unit effort (CPUE) covering the period 1988 to 1997. Due to likely differences in interpretation we used seasonal and monthly comparisons of CPUE. If the current CPUE trend is less than this quantity a review event is triggered.

Using a seasonal comparison, reference points were triggered for the 1998 and 2000 fishing year for Scallops using all grids in calculations, but only the 1998 fishing year was triggered if only scallop grids were used in calculations. This same pattern occurred when using monthly data. However, two out of four months triggered a review event in the 2000 fishing year using scallop grids. Neither the eastern king prawn or north Queensland tiger prawn comparison of seasonal catch rates triggered a review event. Using monthly comparisons, a review event was triggered in the eastern king prawn shallow months using all grids for two out of four months for the 2000 fishing year. One month triggered a review event in the 2000 fishing year for north Queensland tiger prawn.

A range of interpretations can be applied to the current wording of the Trawl Plan. As a consequence management, in consultation with researchers, need to better define the current reference points. The level of acceptable risk of CPUE falling below a reference point also needs to be determined. The validity of using catch rate reference points will be tested in the following chapter.

7.2 INTRODUCTION

A number of biological reference points for effectively managing a fishery have been considered in the past, each one reflecting some aspect of a fisheries response to a harvesting strategy. Reference points can be broadly classed as either 'limit' or 'target'. Limit reference points are based on the biological characteristics of fish stocks, such as investigating how different levels of spawning stock and fishing mortality affect recruitment (Gullestad, 1998). The key objective is never to reach this reference point. For example, ensuring that the spawning biomass is always above a point that guarantees successful recruitment. A complementary measure would be ensuring that fishing mortality is always lower than that which can trigger this reference point.

Similar to limit reference points, a target reference point can be measured in terms of biomass, and fishing mortality, but the objective is to reach this point. The main goal of setting target reference points is achieving sustainable and stable yields and meet management objectives which reduce the risk of overfishing (Seijo and Caddy, 2000). For example (Francis and Shotton, 1997) quote one measure as maximising yield

whilst ensuring that the risk of biomass falling below 20% of virgin biomass is always above 10 percent.

Which reference points to choose (target and limit combined) is determined to a large extent on the type of stock assessment applied, quality of the underlying data and existing and/or proposed management strategies used to regulate the fishery (Seijo and Caddy, 2000). One group of target reference points focuses on yield per recruit as a function of fishing mortality. The main aim of these target reference points is to optimise harvesting rates in relation to population size parameters such as growth and natural mortality (Beverton and Holt, 1957). One type, F_{max} is the fishing mortality rate at which the yield per recruit is maximised (Beverton and Holt, 1957). It is also called Maximum Sustainable Yield or MSY in other texts. However, MSY is more likely to be treated as a limit reference point due to the uncertainty surrounding the actual point of maximum yield. Related to F_{max} is $F_{0.1}$, which is the fishing mortality rate where the slope of the yield per recruit curve is 10% of the slope at the origin (Gulland and Boerema, 1973). These reference points potentially result in yields at or near maximum from a fishery, assuming recruitment is independent of stock size.

Reductions in recruitment are often evident when stocks are depleted to low levels and can lead to a decline in abundance through recruitment overfishing (Sissenwine and Shepherd, 1987). To reduce the probability of recruitment overfishing caused by using MSY-based reference points, other reference points have been developed. These reference points are based on stock-recruitment relationships. For example, F_{med} is the fishing mortality rate based on the median of the observed levels of recruits produced per unit of spawning stock biomass (R/SSB) (Sissenwine and Shepherd, 1987). The appeal of using this F_{med} as a reference point is that abundance is maintained when the spawning stock biomass produced by a single cohort over its lifetime is equal to the SSB of the parent population when the cohort was spawned.

Related to F_{med} is a set of reference points based on the spawning stock biomass per recruit (SSB/R) (Clark, 1991). These reference points are termed percent maximum spawning potential (%MSP) or spawning per recruit (SPR) reference points. There is no agreement among researchers on which is the most appropriate reference point, target or limit to base management decisions upon (Hilborn, 1997).

7.2.1 Current Queensland reference points

When the East Coast Otter Trawl Management Plan was drafted there was little research into fishery performance indicators such as reference points. As a consequence interim reference points were established for each trawl sector. They were defined as ‘review events’ under Schedule 2, section 8(a), of the Fisheries (East Coast Trawl) Management Plan 1999.

A review event is defined as the, ‘...CPUE for the following principal fish in the following periods is less than 70% of the average CPUE for the principal fish from 1988 to 1997’.

The above statement is interpreted as meaning all data are aggregated over the specific review period. For example, the mean CPUE for saucer scallops is taken as the sum of catch from November to the end of February divided by the sum of effort

in the same period. However, there is still some debate on whether this is true. A Queensland Fishery Service departmental working paper (SCFA report cards, 2001) has defined a review event as triggered when CPUE drops below 70% for consecutive months within a review period. However, how many months was not defined.

The review periods for the species of concern for this project are:

- For eastern king prawns — 1 November to the end of February and May 1 to 31 August
- For saucer scallops — 1 November to end of February
- For north Queensland tiger prawns — 1 March to 30 June and 1 September to 31 December.

These review periods typically coincide with times of high catches where major recruitment or spawning events occur. For example, the May 1 to August 31 review period coincides with eastern king prawn spawning migration to the Swains Reef. The reference point of 70% of average CPUE was based largely on anecdotal evidence due to paucity of information obtainable from the literature (Mike Dredge, pers. comm. 2001). However, no mention has been made regarding the degree of management action based on the probability associated with triggering a review event. A similar management arrangement implemented in the south east fishery of Australia has been highly criticised (Punt et al., 2001).

7.3 METHODS

The following figures summarise possible interpretations of the text within the trawl management plan explained above.

Three sectors are examined:

- Scallop
- EKP Deep & Shallow and
- north Queensland tiger prawns.

The QFISH 30' × 30' grids that best describe these sectors are listed in Table 7.3.1.

Table 7.3.1 QFISH grids associated with each fishery

Fishery	QFISH grids
Scallop	S28, S29, T28, T29, T30, U30, U31, V31, V32
Eastern king prawn shallow	W33, W34, W35, W36
Eastern king prawn deep	W26, W27, W28, V28, U28, U29, V30, V31
North Queensland tiger prawn	< 17°S

To compare yearly catch rates with the long-term 70% catch rate a number of options are available. The first option is to compare catch rates only within the relevant QFISH grids where the majority of the catch is historically caught. In this case the headings of the graphs will say 'Scallop grids', for example.

The second option is to include all grids. For the eastern king prawns the two review periods are attempting to represent recruitment and spawning seasons. To represent the appropriate stock, the month in which the catch may be taken — from all grids —

may be assumed to coincide with either recruitment or spawning stock. In this case the headings of the graphs will say ‘all grids, shallow months’, for example.

Nominal and standardised effort is included to examine the effect changes in fishing power has on the probability of triggering review events. Fishing power has been calculated from 1989 to 1999. Fishing power has generally increased linearly over time. Fishing power for 2000 and 2001 was based on predicted values obtained from linear regressions of fishing power over time for each sector.

The probability of triggering a review event was calculated from a sample T distribution with the following properties:

$$T = \frac{\bar{X} - \mu}{s/\sqrt{n}}$$

where \bar{X} – average CPUE within a review period in any one fishing year (1998 onwards)

μ – long-term average 70% CPUE within a period for the years 1988–1997 inclusive.

s – standard deviation of μ

n – number of sample points (i.e. ten from 1988–1997)

The T value was compared with the critical t-value taken from a one-tail t distribution with $n-1$ degrees of freedom to obtain a probability of triggering a review event.

7.3.1 Chart interpretation

The following explains the symbols and bars of all the charts.

- Blue bars represent average CPUE for the period in individual years.
- Red bars represent 70% of the average CPUE calculated from 1988–1997.
- Yellow bars represent the probability of triggering a review event. The higher the probability the greater the likelihood that a review event has been truly triggered.

7.4 RESULTS

7.4.1 Review period charts based on average over all months within period.

7.4.1.1 Scallops

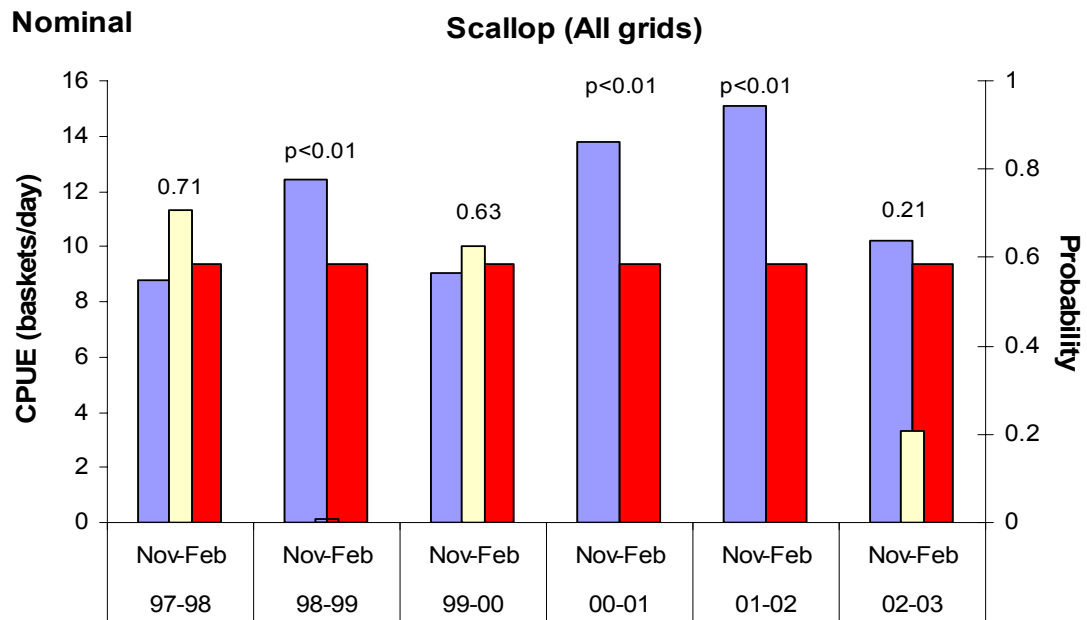

Figure 7.4.1 Comparison of nominal CPUE with 70% CPUE for Scallops (All grids). Review events were triggered for the 97–98 and 99–00 fishing season.

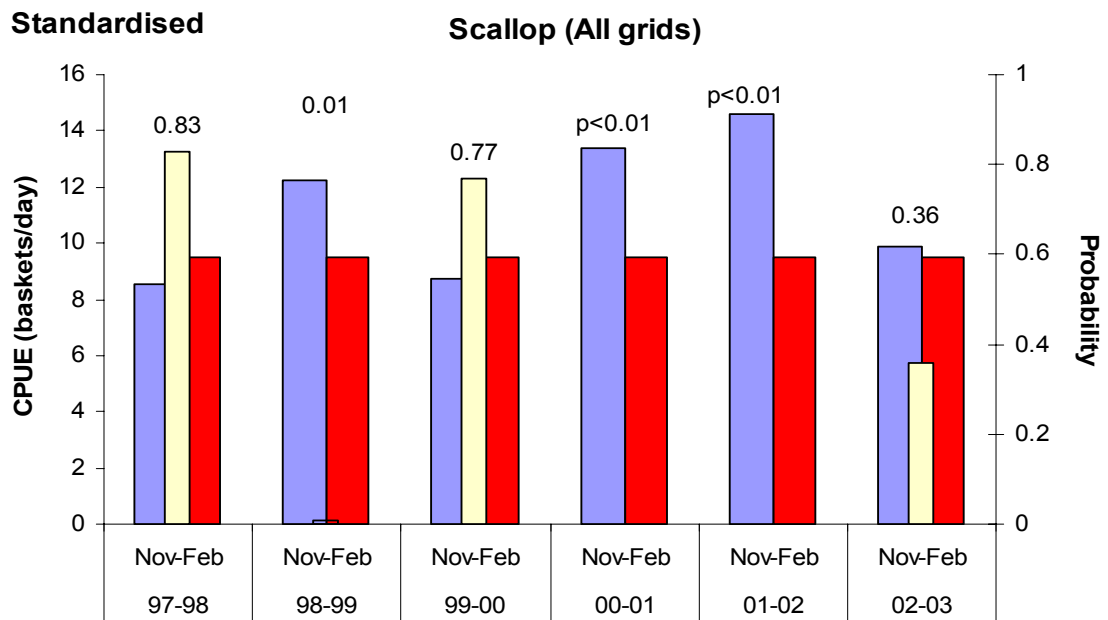

Figure 7.4.2 Comparison of standardised CPUE with 70% CPUE for Scallops (All grids). Review events were triggered for the 97–98 and 99–00 fishing season.

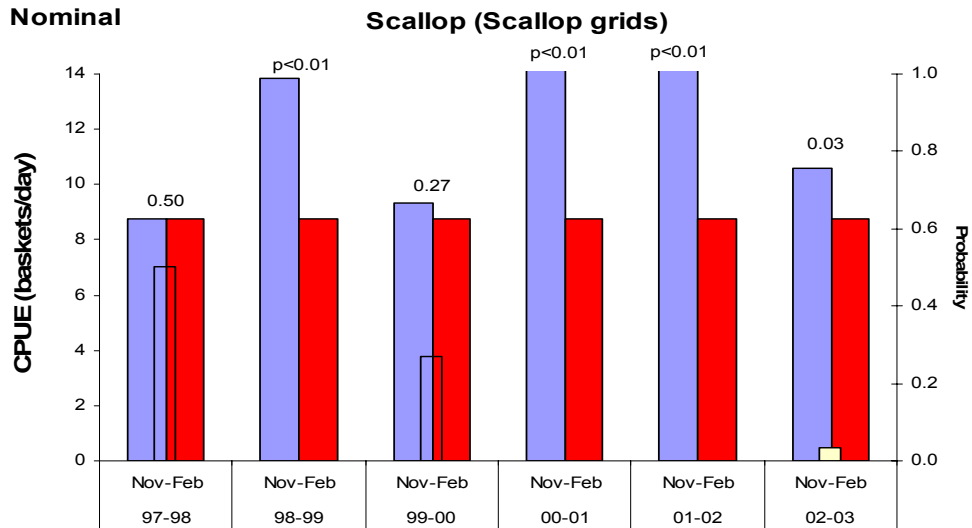

Figure 7.4.3 Comparison of nominal CPUE with 70% CPUE for Scallops (Scallop grids). There was a 50% chance of triggering a review event in the 97–98 fishing season.

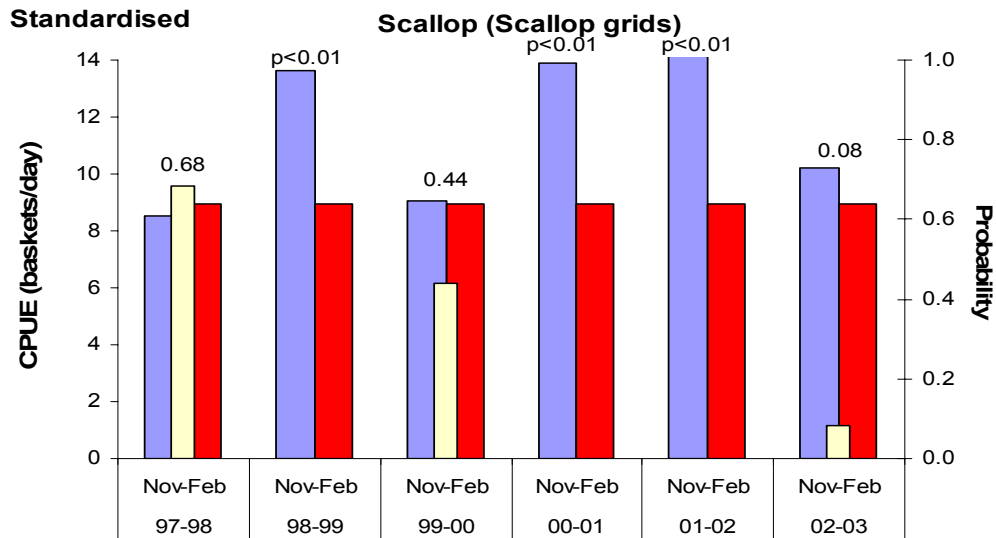

Figure 7.4.4 Comparison of standardised CPUE with 70% CPUE for Scallops (Scallop grids). There was a 68% chance of triggering a review event in the 97–98 fishing season

Review events were triggered in 1997–98 and again in 1999–2000 for both nominal and standardised CPUE using data from all grids (Figure 7.4.1 and Figure 7.4.2). When using only data from the scallop grids only the 1997–98 period is triggered. However, there was still a 44% chance of triggering a review event for standardised CPUE in the 1999–2000 fishing year (Figure 7.4.4). There was a 36% risk of triggering a review event in 2002–2003 using standardised CPUE data for all grids (Figure 7.4.2).

7.4.1.2 Eastern King Prawns

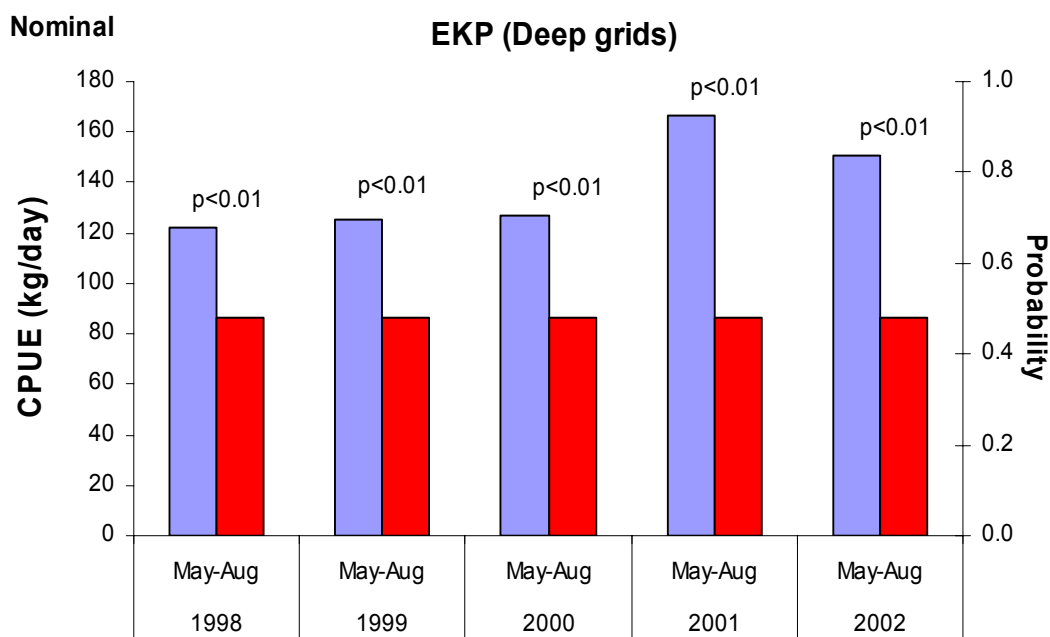

Figure 7.4.5 Comparison of nominal CPUE with 70% CPUE for Eastern King Prawn (Deep grids). No review events were triggered.

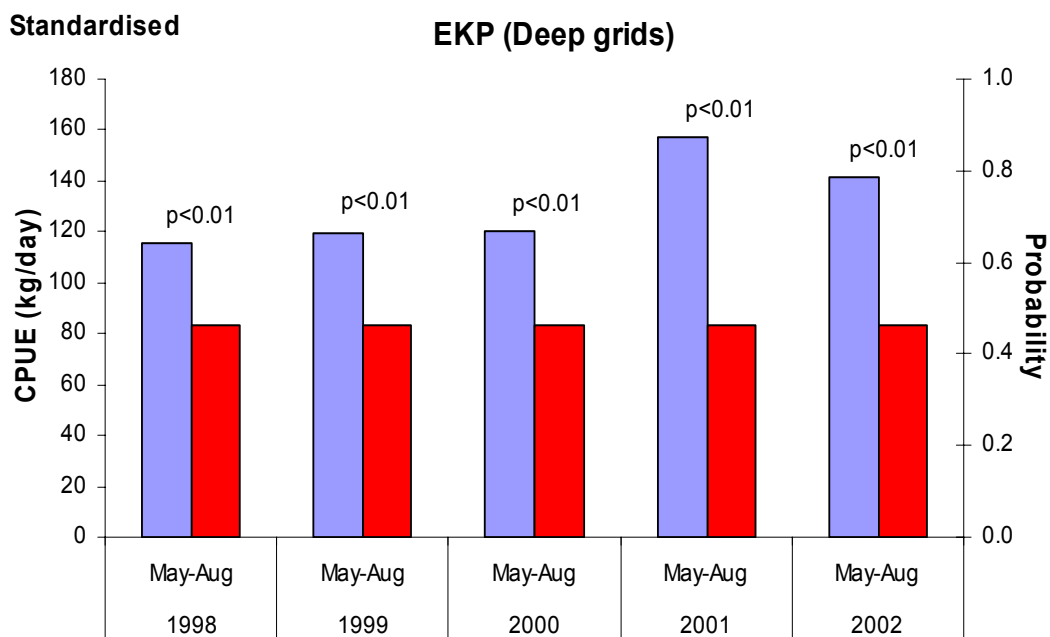

Figure 7.4.6 Comparison of standardised CPUE with 70% CPUE for Eastern King Prawn (Deep grids). No review events were triggered.

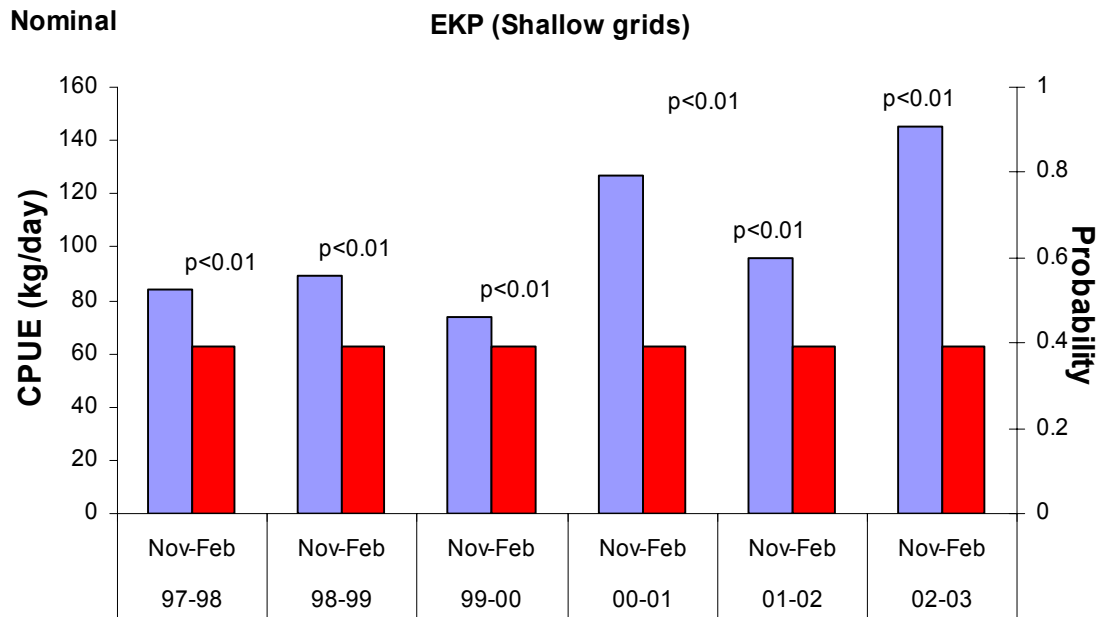

Figure 7.4.7 Comparison of nominal CPUE with 70% CPUE for Eastern King Prawn (Shallow grids). No review events were triggered.

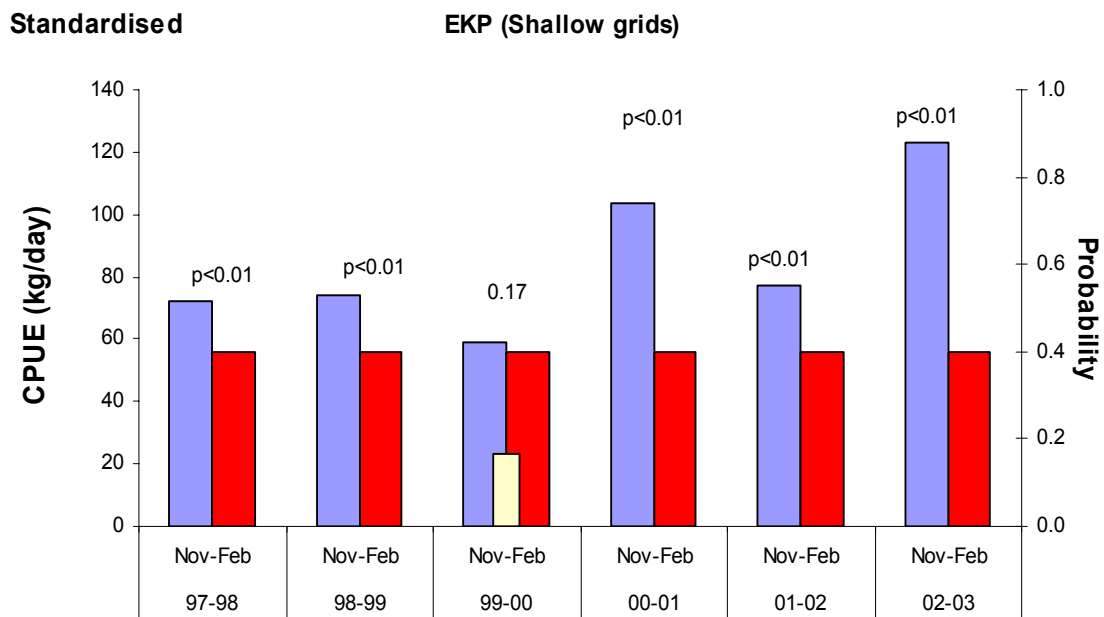

Figure 7.4.8 Comparison of standardised CPUE with 70% CPUE for Eastern King Prawn (Shallow grids). No review events were triggered. However, in the 99–00 fishing year there was a 17% likelihood of catch-rates falling below the 70% limit reference point.

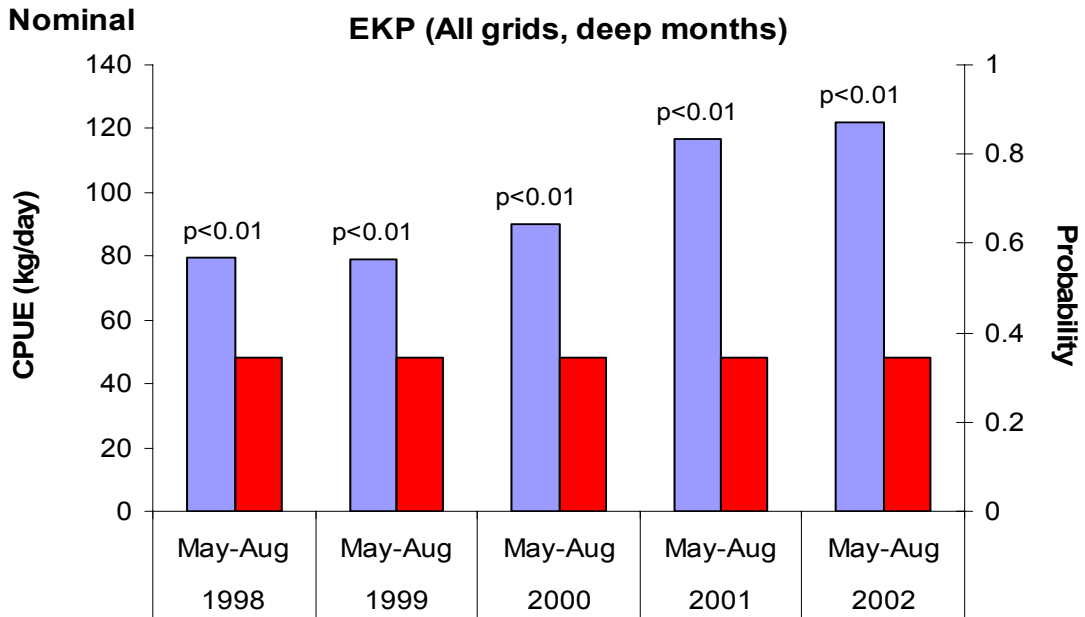

Figure 7.4.9 Comparison of nominal CPUE with 70% CPUE for Eastern King Prawn (All grids, deep months). No review events were triggered.

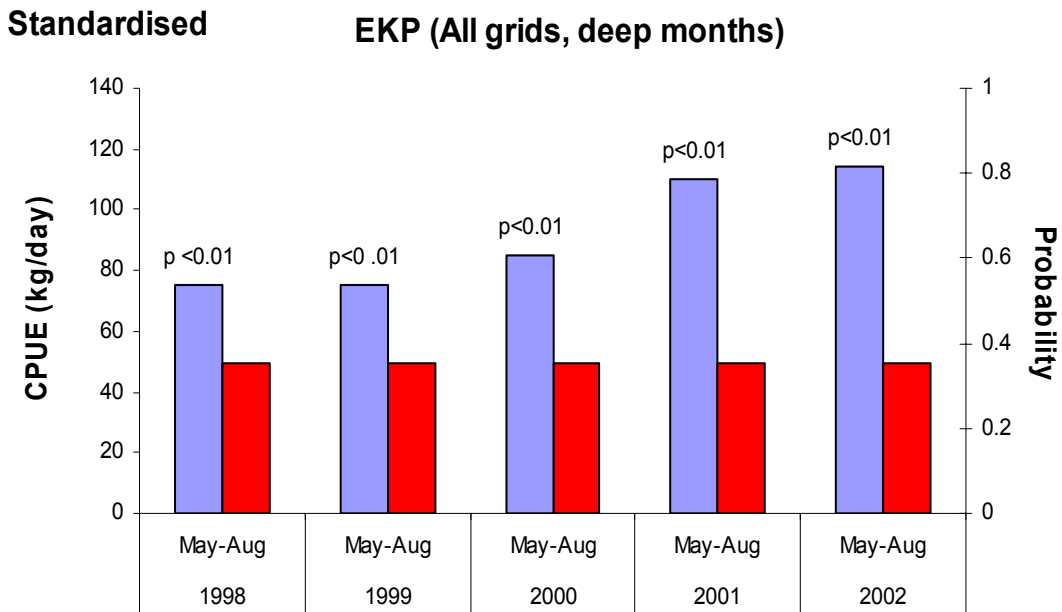

Figure 7.4.10 Comparison of standardised CPUE with 70% CPUE for Eastern King Prawn (All grids, deep months). No review events were triggered.

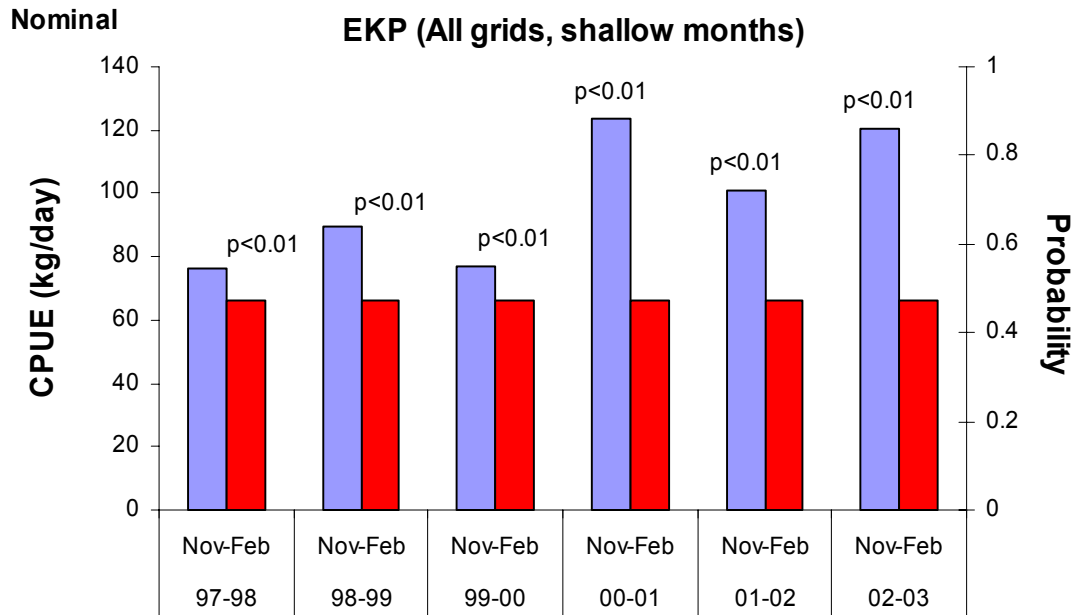

Figure 7.4.11 Comparison of nominal CPUE with 70% CPUE for Eastern King Prawn (All grids, shallow months). No review events were triggered.

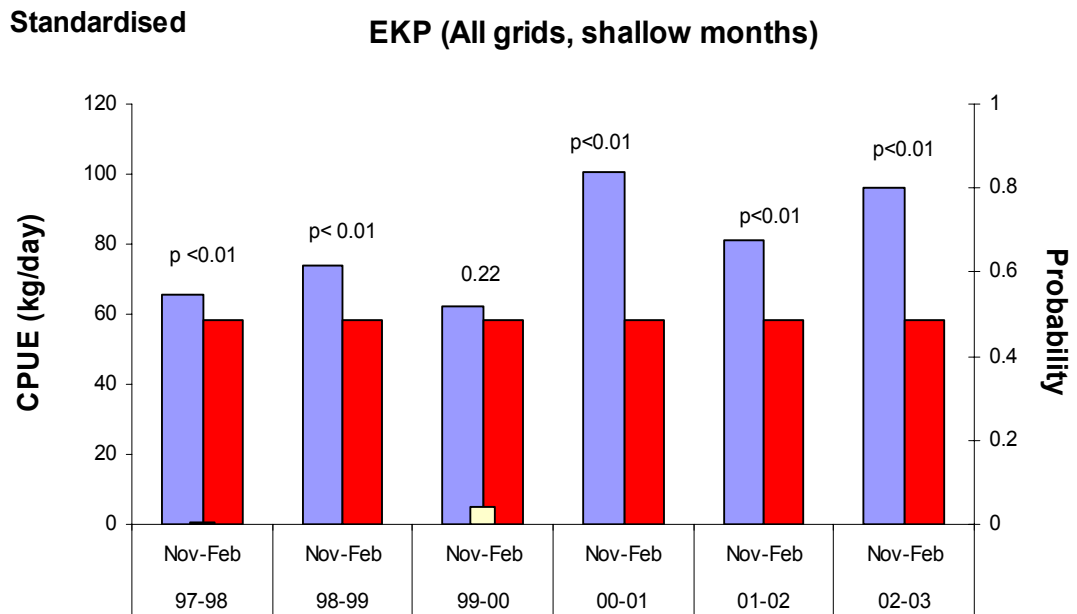

Figure 7.4.12 Comparison of standardised CPUE with 70% CPUE for Eastern King Prawn (All grids, shallow months). No review events were triggered. However in the 99–00 fishing year there was a 22% likelihood of catch-rates falling below the 70% limit reference point.

No review events have been triggered in either the shallow or deep EKP sector (Figure 7.4.5 to Figure 7.4.12). There was only a slight risk of triggering a review event in the 1999–2000 fishing year for standardised CPUE in the recruitment period (i.e. November to February, shallow grids) of 17% and 22% using shallow grids only (Figure 7.4.8 and Figure 7.4.12).

7.4.1.3 North Queensland Tiger prawns

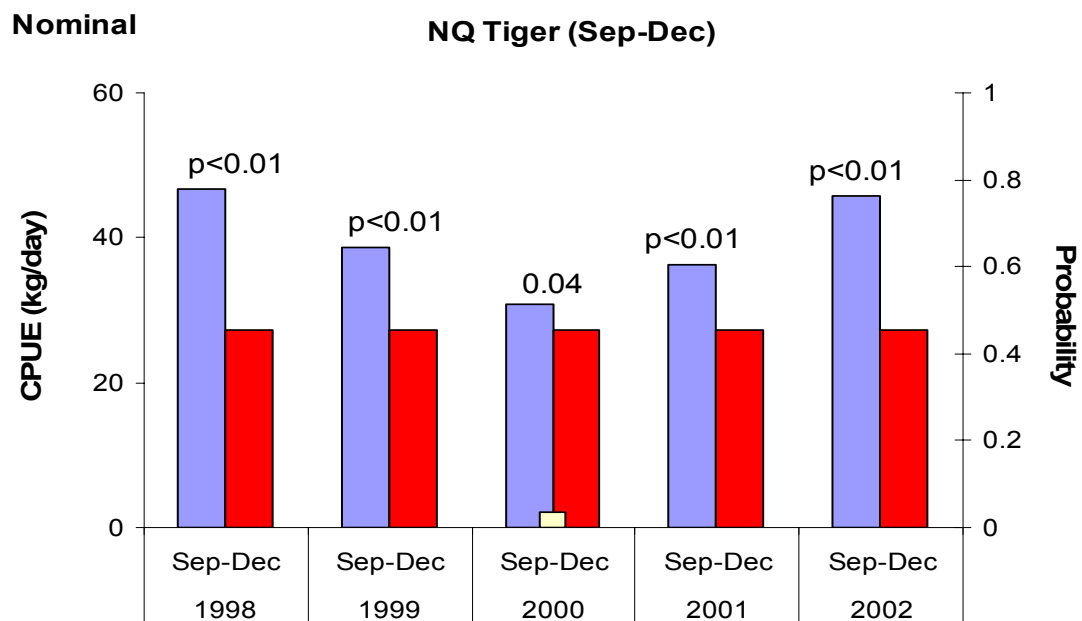

Figure 7.4.13 Comparison of nominal CPUE with 70% CPUE for NQ Tiger Prawn (NQ grids, Sep-Dec). No review events were triggered.

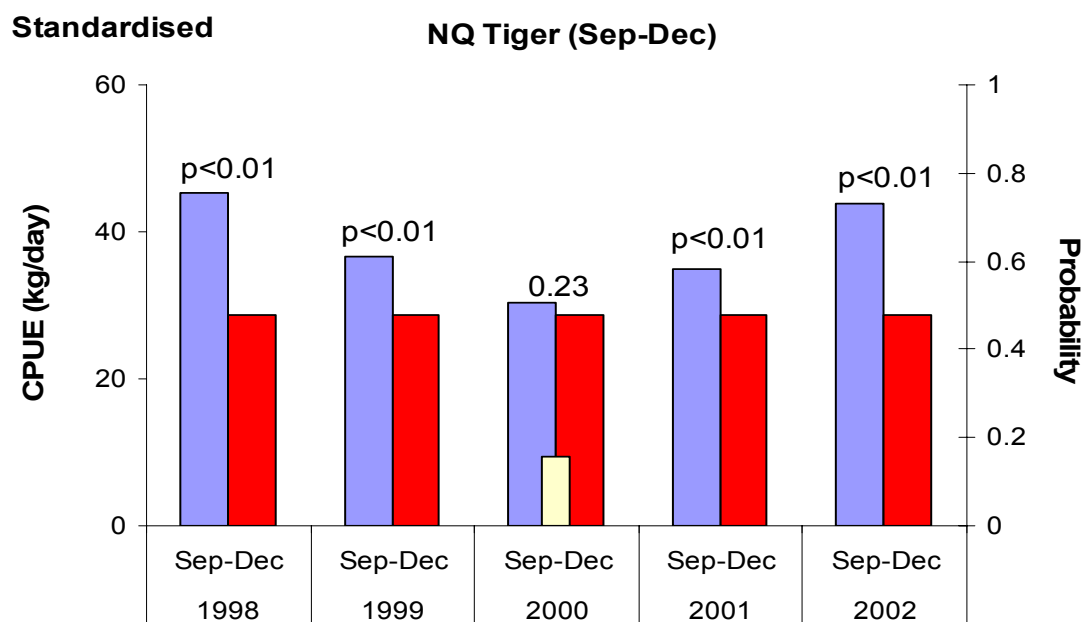

Figure 7.4.14 Comparison of standardised CPUE with 70% CPUE for NQ Tiger Prawn (NQ grids, Sep-Dec). No review events were triggered. However, in the 2000 fishing year there was a 23% likelihood of catch-rates falling below the 70% limit reference point.

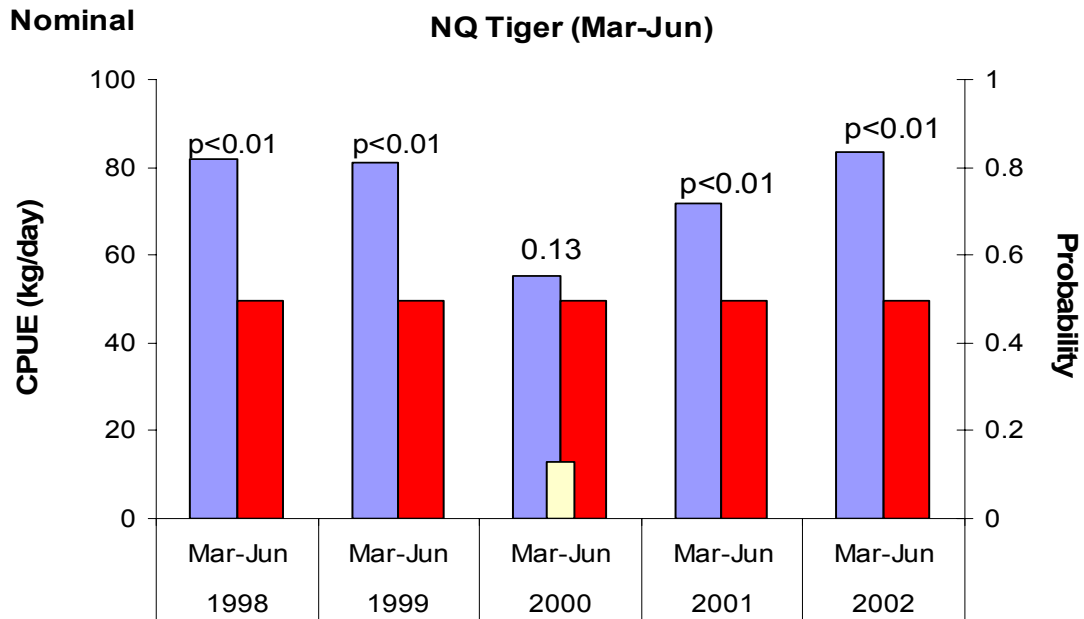

Figure 7.4.15 Comparison of nominal CPUE with 70% CPUE for NQ Tiger Prawn (NQ grids, Mar–Jun). No review events were triggered. However, in the 2000 fishing year there was a 13% likelihood of catch-rates falling below the 70% limit reference point.

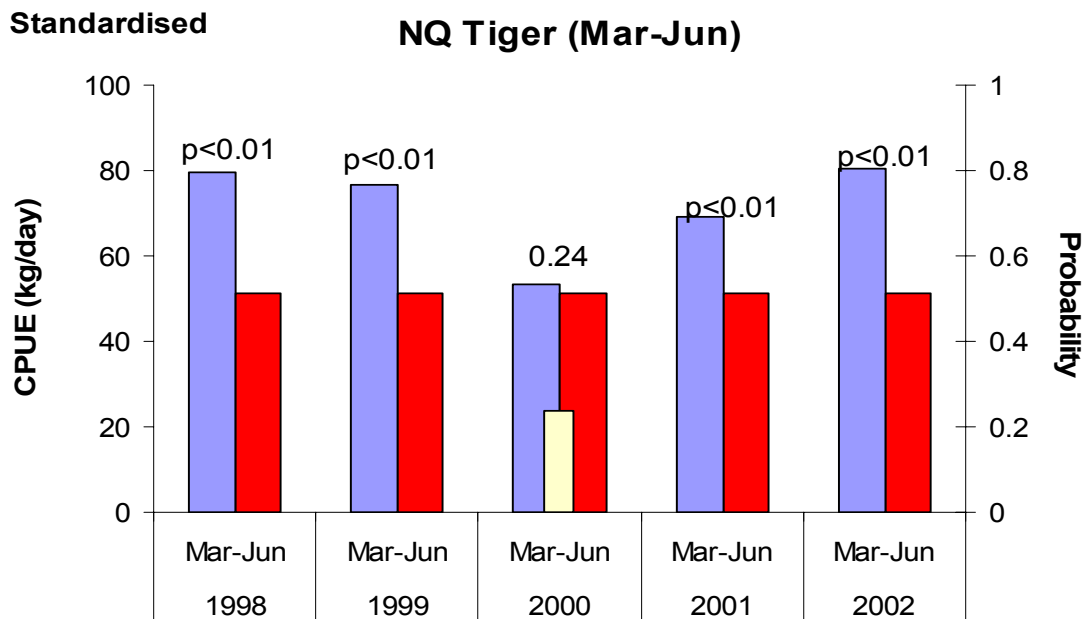

Figure 7.4.16 Comparison of standardised CPUE with 70% CPUE for NQ Tiger Prawn (NQ grids, Mar–Jun). No review events were triggered. However, in the 2000 fishing year there was a 24% likelihood of catch-rates falling below the 70% limit reference point.

No review events were triggered for NQ Tigers. However it is clear that the standardised CPUE series significantly increases the risk of triggering and review event – from 13% nominal to 24% standardised (Figure 7.4.15 and Figure 7.4.16).

7.4.2 Review period charts based on each month within a period.

The following charts track CPUE trends over each month of a review period.

7.4.2.1 Scallop

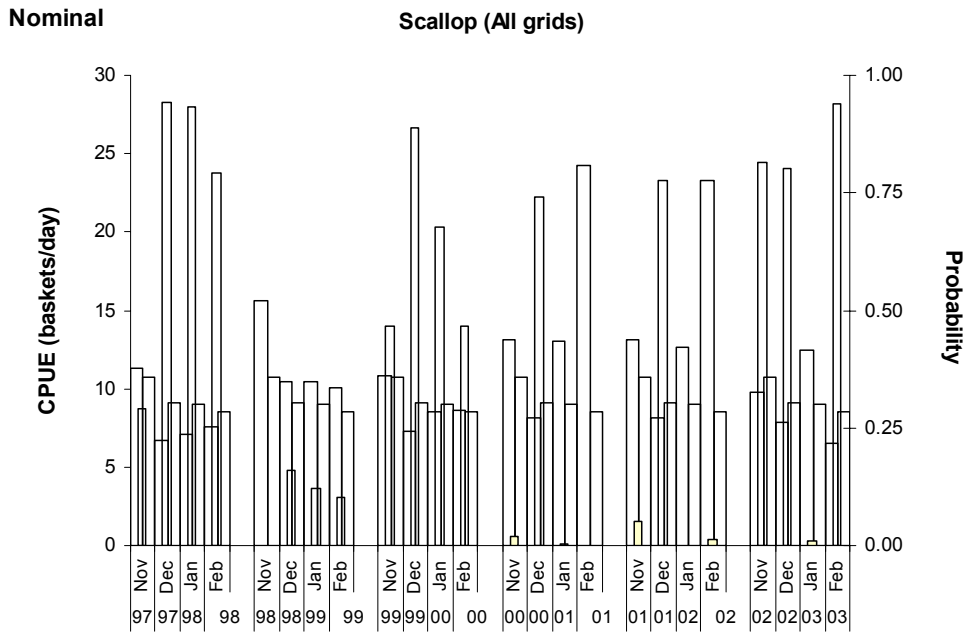

Figure 7.4.17 Comparison of monthly nominal CPUE with 70% CPUE for Scallops (All grids). Review events were triggered for three out of four months in the 97–98 and 02–03 fishing season, twice in the 99–00 fishing season, once in the 00–01 and 01–02 fishing season, but not in the 98–99 fishing season.

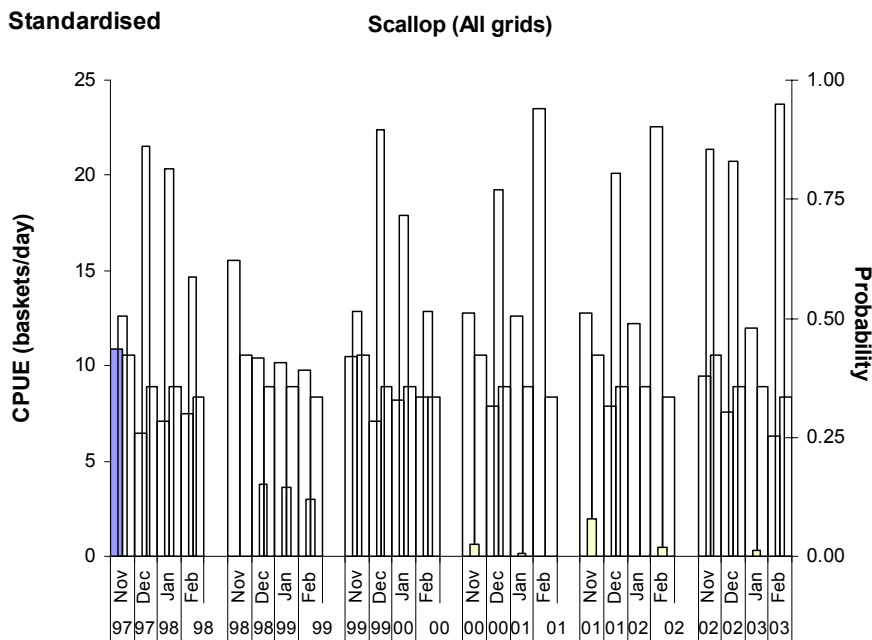

Figure 7.4.18 Comparison of monthly standardised CPUE with 70% CPUE for Scallops (All grids). Review events were triggered for all months in the 99–00 fishing season, three out of four months in the 97–98 and 02–03 fishing season, once in the 00–01 and 01–02 fishing season, but not in the 98–99 fishing season.

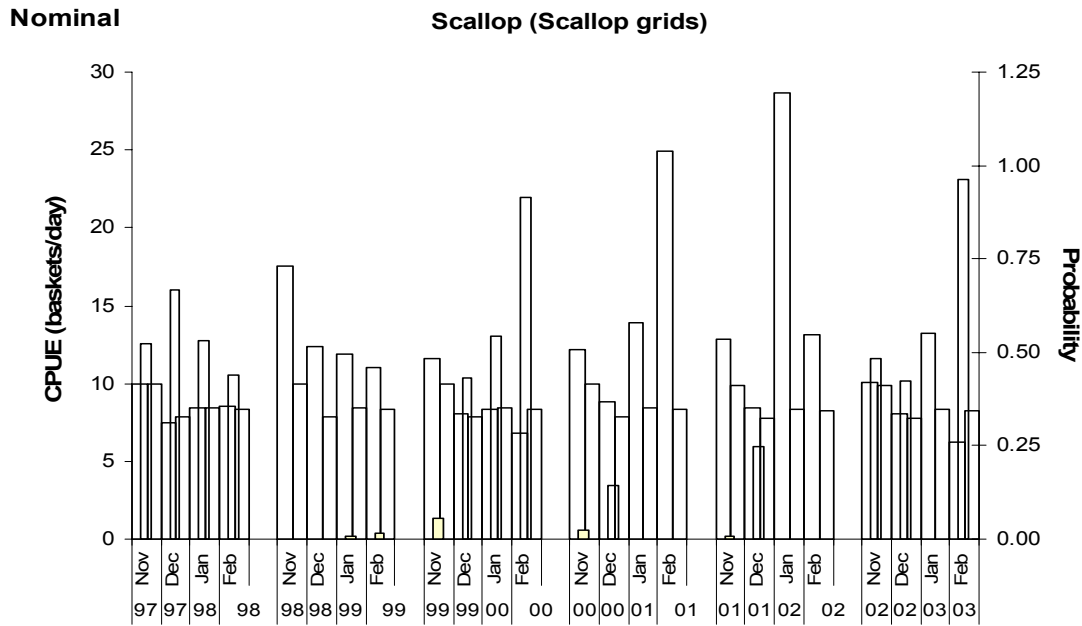

Figure 7.4.19 Comparison of monthly nominal CPUE with 70% CPUE for Scallops (Scallop grids). Review events were triggered for three out of four months in the 97–98 fishing season, twice in the 99–00 fishing season, once in the 02–03 fishing season, but not in the 98–99, 00–01 and 01–02 fishing season.

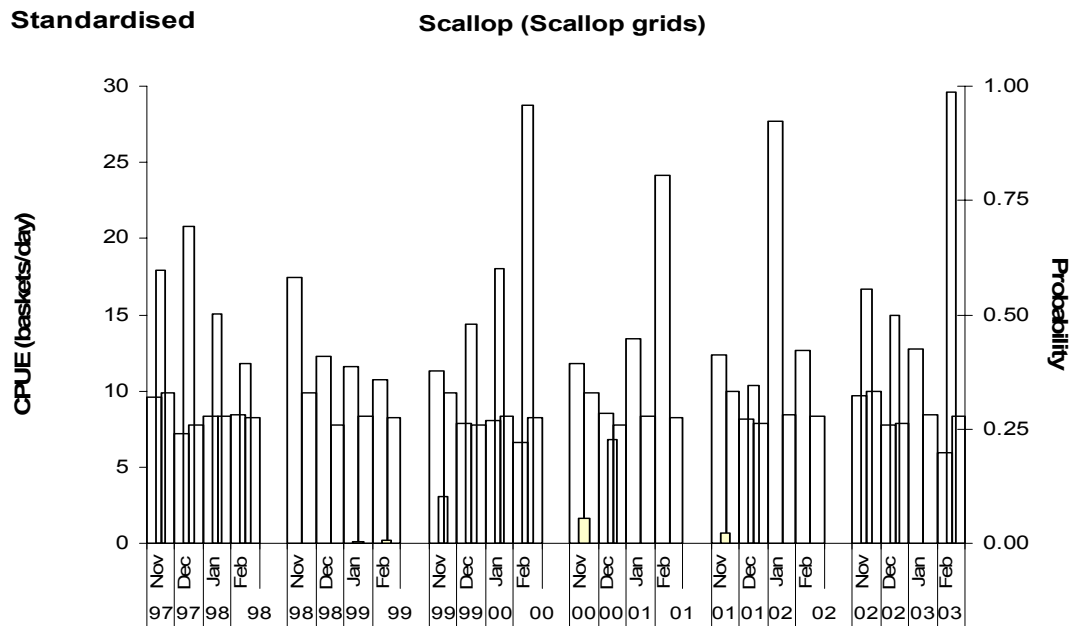

Figure 7.4.20 Comparison of monthly standardised CPUE with 70% CPUE for Scallops (Scallop grids). Review events were triggered for three out of four months in the 97–98 fishing season, twice in the 99–00 and 02–03 fishing season. However, in both later cases they fail to reach the required 50% by less than 2%. No other months within fishing seasons trigger a review event.

A clearer picture of the seasonal trend in catch rates appears when looking at monthly Scallop CPUE series. Previously (i.e. Figure 7.4.1 and Figure 7.4.2) there was little or no risk of triggering a review event in 2000–01 and 2001–02 fishing years. However, it can be seen that for December 2000, 2001 and 2002 there was a very high

probability that a review event was triggered for nominal and standardised data (Figure 7.4.17 and Figure 7.4.18). The high catch rates for February 2001 and February 2002 effectively mask these events. This pattern was not as evident for CPUE calculated from the scallop grids (Figure 7.4.19 and Figure 7.4.20). The relatively low risk of triggering a review event in 2002–03 as seen in Figure 7.4.1, Figure 7.4.2 and Figure 7.4.4, masks three months of triggering in the monthly graphs Figure 7.4.17, Figure 7.4.18 and Figure 7.4.20. In all cases the high catches in January counter any effect from low catches in the other three months in the review period.

There was a different pattern in monthly triggers when comparing CPUE calculated for all grids compared with scallop grids for the three fishing years prior to 2000-01. A low risk of triggering in November 1997 using all grids (~25–40%) contrasts with a much higher risk of triggering using scallop grids only (~50–60%) (Figure 7.4.17 to Figure 7.4.20). Similarly, for all grids the risk of triggering a review event essentially begins low and increases over the 1999–2000 fishing year, as opposed to data based on scallop grids where the converse occurs.

7.4.2.2 Eastern King Prawn

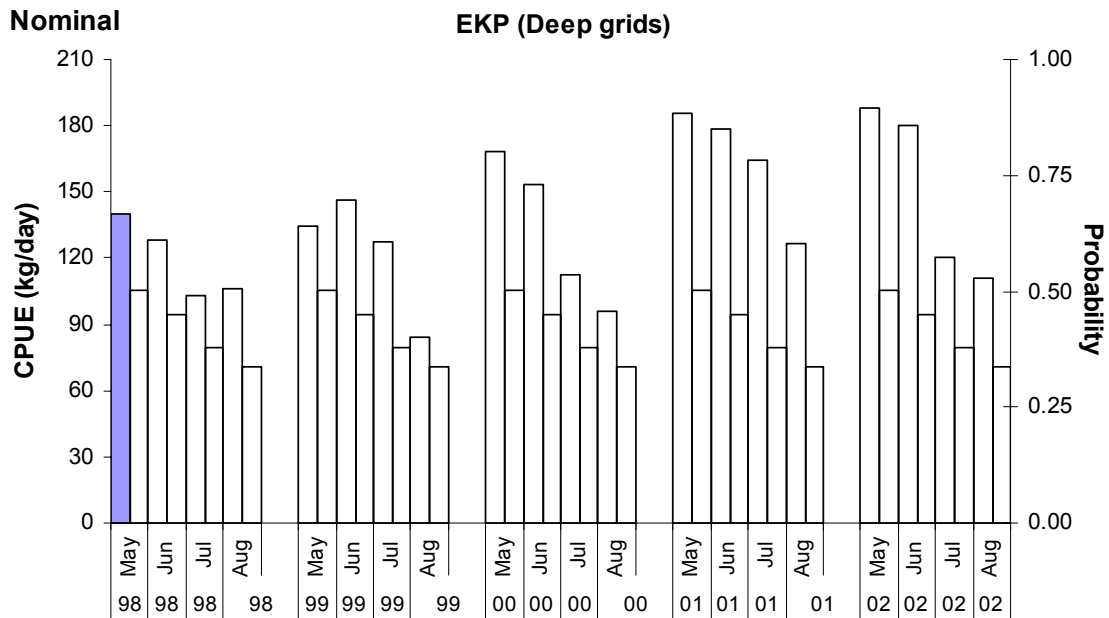

Figure 7.4.21 Comparison of monthly nominal CPUE with 70% CPUE for EKP (Deep grids). No review events were triggered for any fishing year.

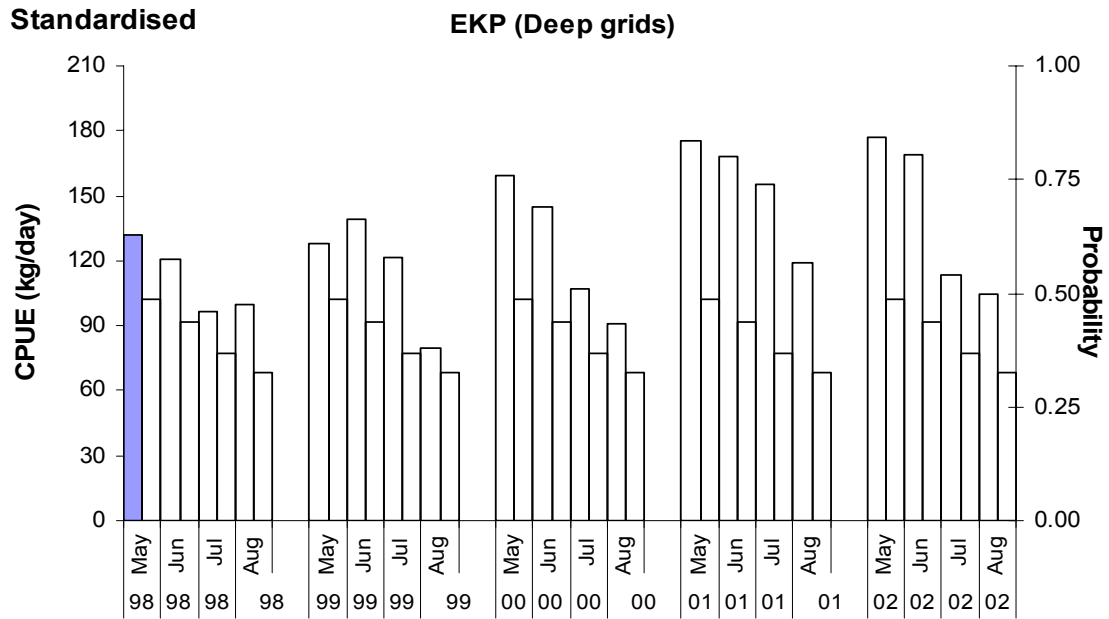

Figure 7.4.22 Comparison of monthly standardised CPUE with 70% CPUE for EKP (Deep grids). No review events were triggered in any fishing season.

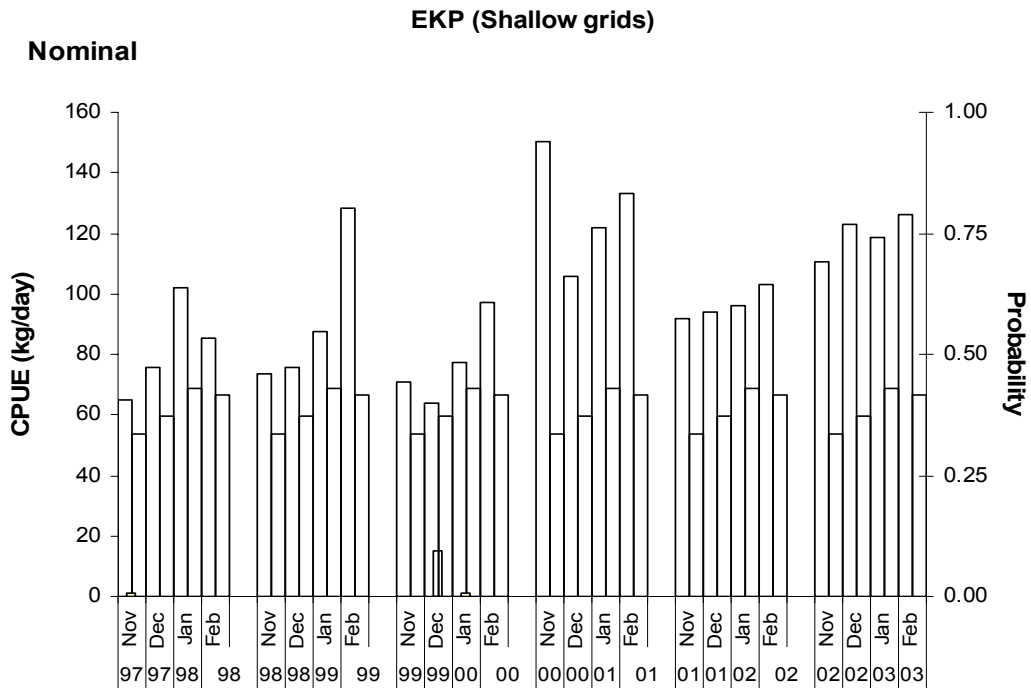

Figure 7.4.23 Comparison of monthly nominal CPUE with 70% CPUE for EKP (Shallow grids). No review events were triggered in any fishing season.

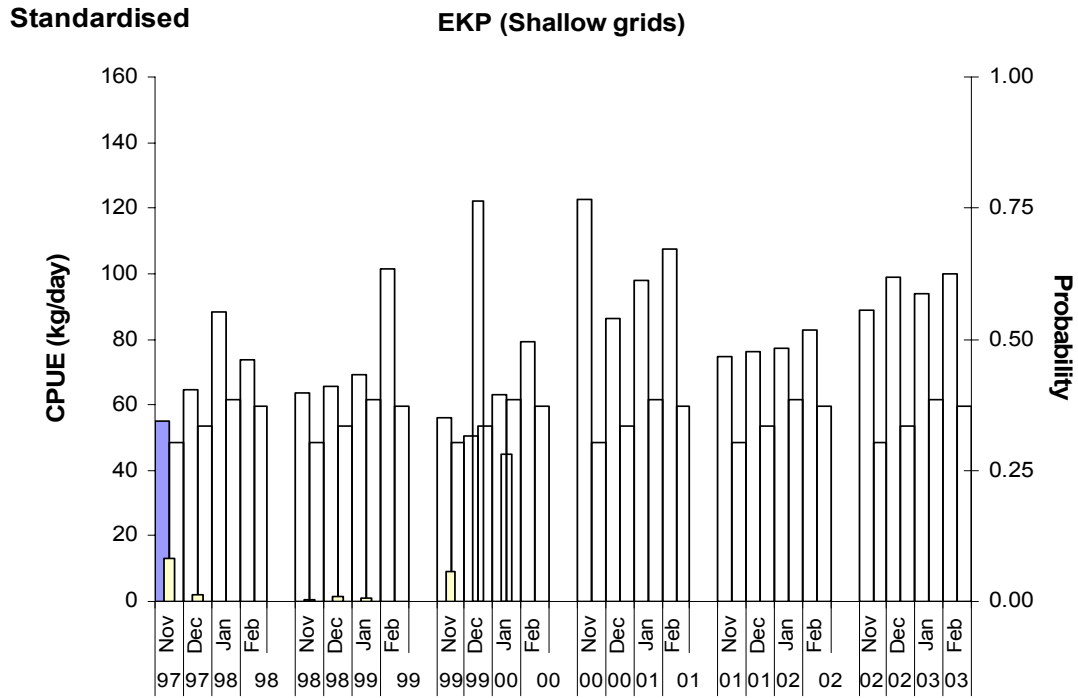

Figure 7.4.24 Comparison of monthly standardised CPUE with 70% CPUE for EKP (Shallow grids). Catch-rates fell below the 70% limit reference point in December 1999 only. No other review events were triggered in any fishing season.

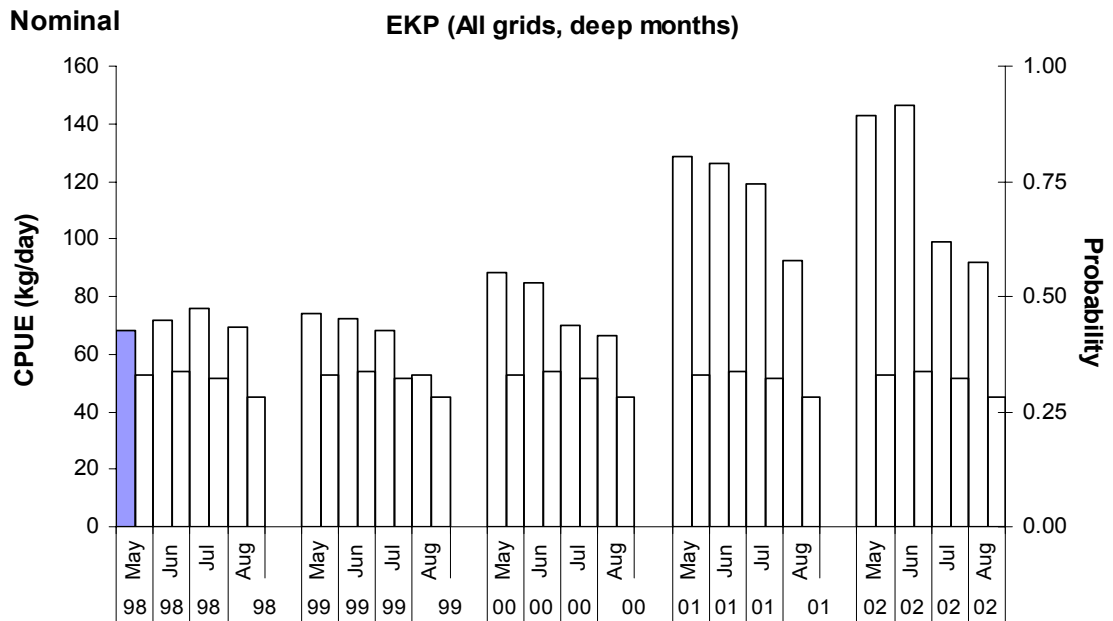

Figure 7.4.25 Comparison of monthly nominal CPUE with 70% CPUE for EKP (All grids, deep months). No review events were triggered in any fishing season.

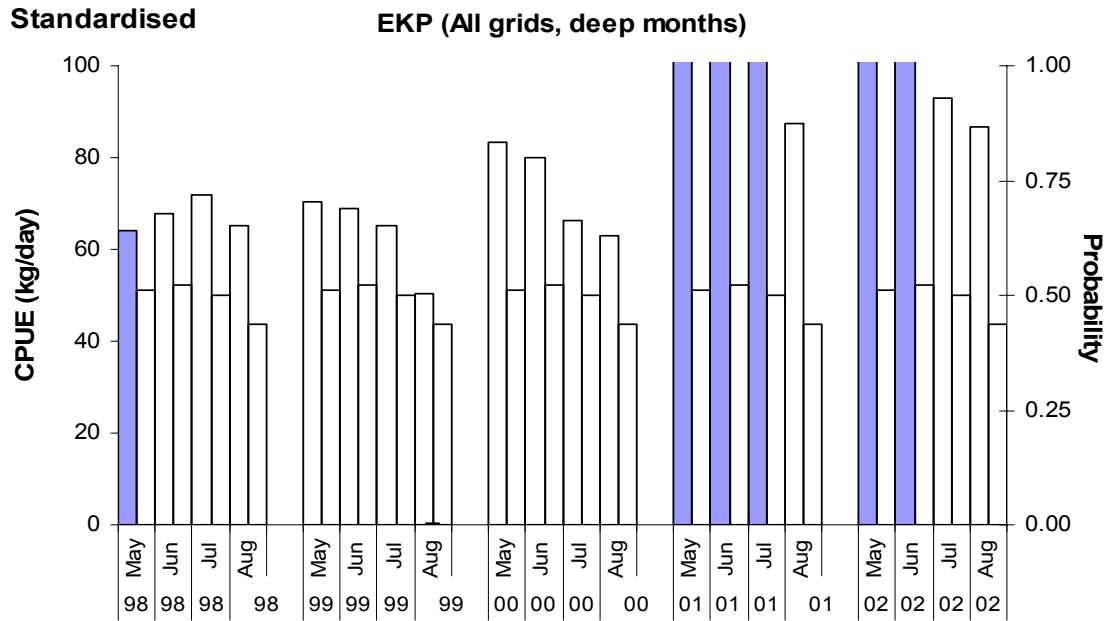

Figure 7.4.26 Comparison of monthly standardised CPUE with 70% CPUE for EKP (All grids, deep months). No review events were triggered in any fishing season.

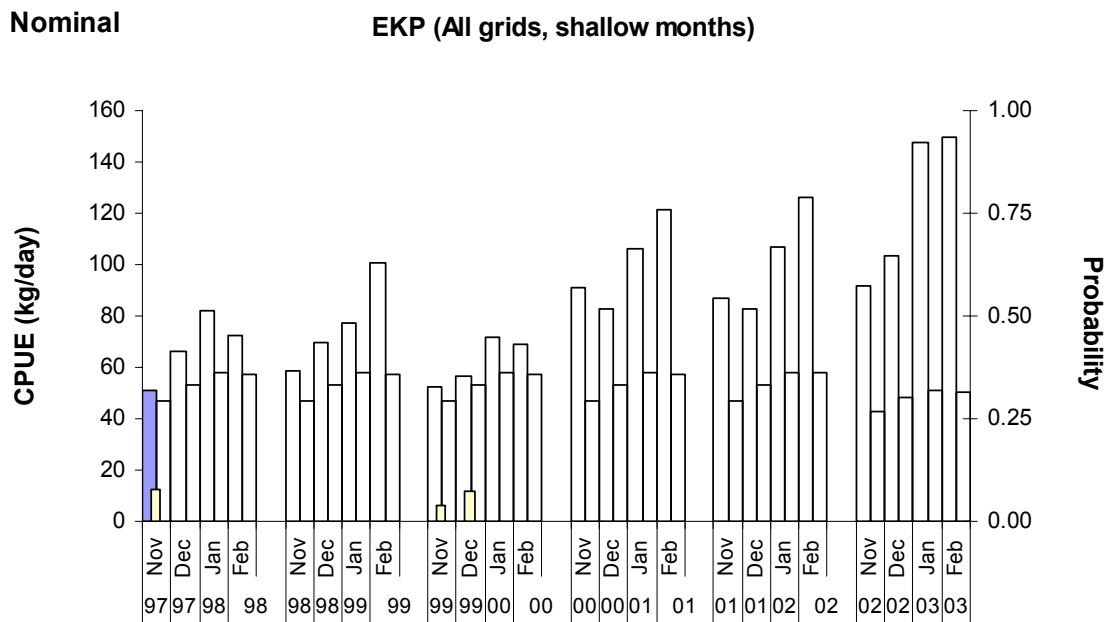

Figure 7.4.27 Comparison of monthly nominal CPUE with 70% CPUE for EKP (All grids, shallow months). No review events were triggered in any fishing season.

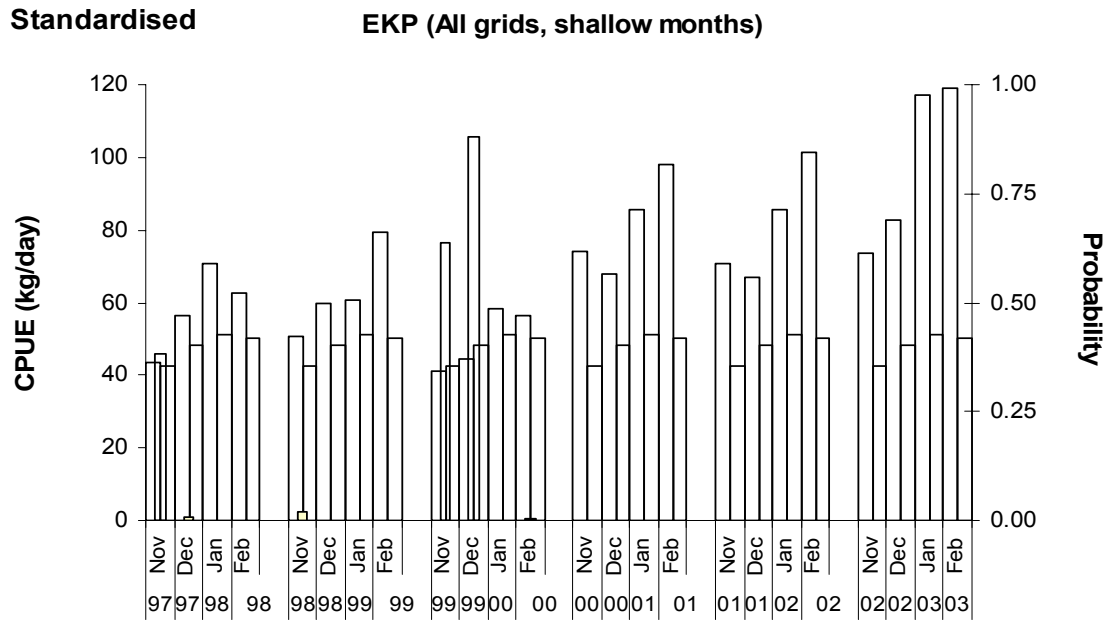

Figure 7.4.28 Comparison of monthly standardised CPUE with 70% CPUE for EKP (All grids, shallow months). A review event was triggered for November and December 1999. No review events were triggered in any other fishing season.

The risk of triggering a review event over months within a period is certainly not evenly spread, making interpretation of mean risk less than straightforward. Whereas average risk was only 17% for the 1999–2000 fishing year using shallow grid standardised CPUE data (Figure 7.4.8), the monthly risk varied widely from ~5 to 75% (Figure 7.4.24). A similar pattern emerges from the all grids, shallow months graphs. The average for the period is 22% (Figure 7.4.12) and the monthly risk varies from 0 to ~90% (Figure 7.4.28).

7.4.2.3 North Queensland Tiger Prawn

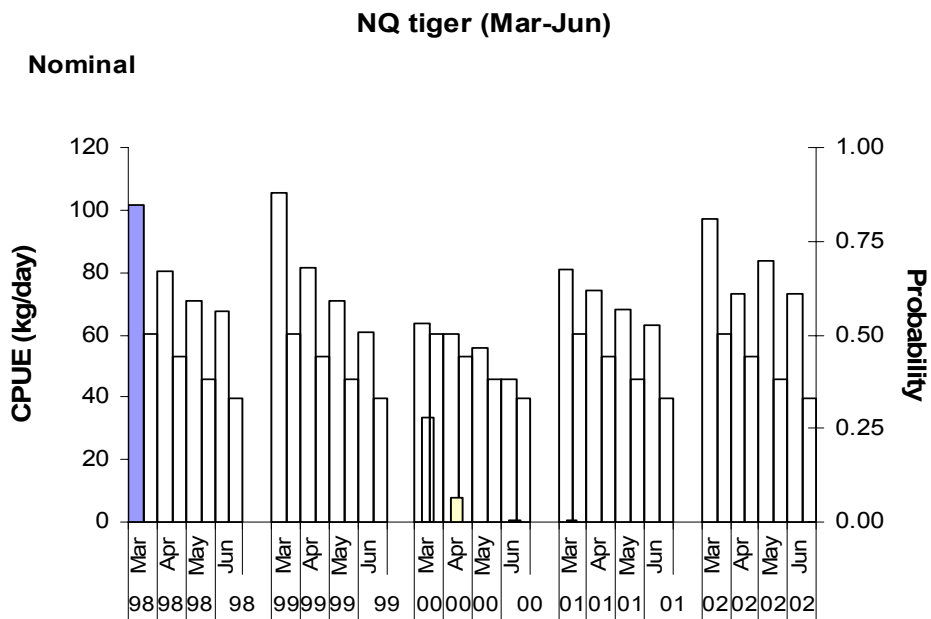

Figure 7.4.29 Comparison of monthly nominal CPUE with 70% CPUE for NQ Tiger (Mar–Jun). No review events were triggered in any fishing season.

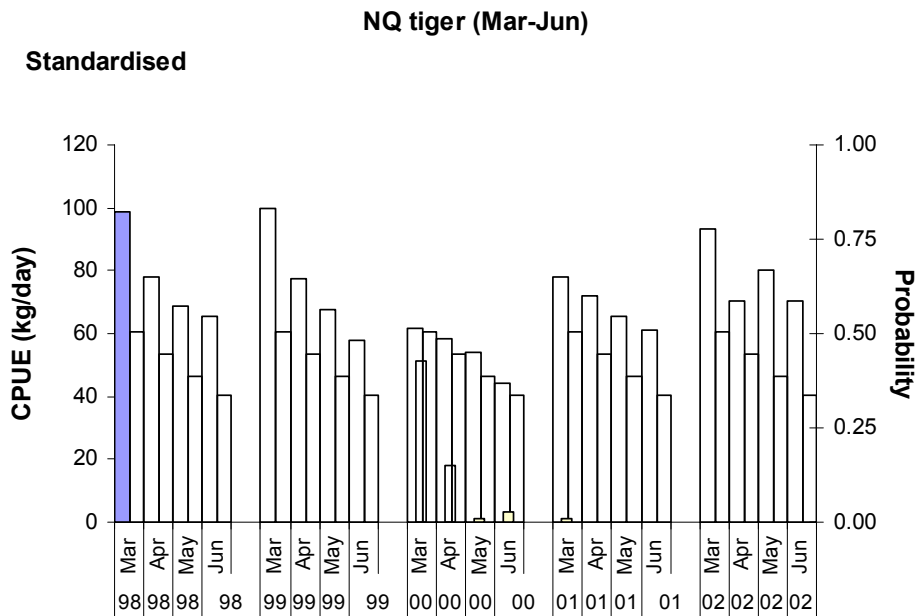

Figure 7.4.30 Comparison of monthly standardised CPUE with 70% CPUE for NQ Tiger (Mar–Jun). No review events were triggered in any fishing season. There was a 42% probability of triggering a review event in March 2000.

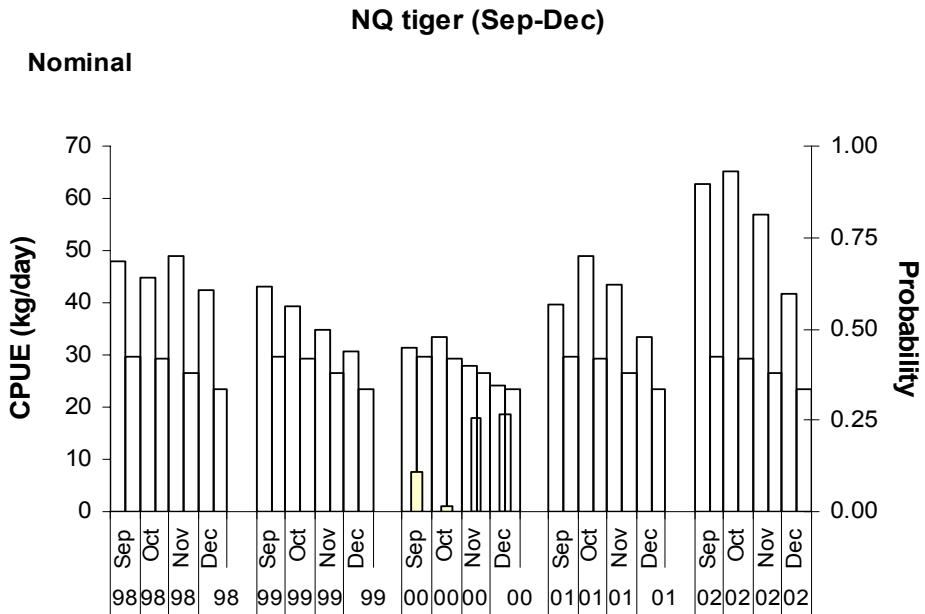

Figure 7.4.31 Comparison of monthly nominal CPUE with 70% CPUE for NQ Tiger (Sep-Dec). No review events were triggered in any fishing season.

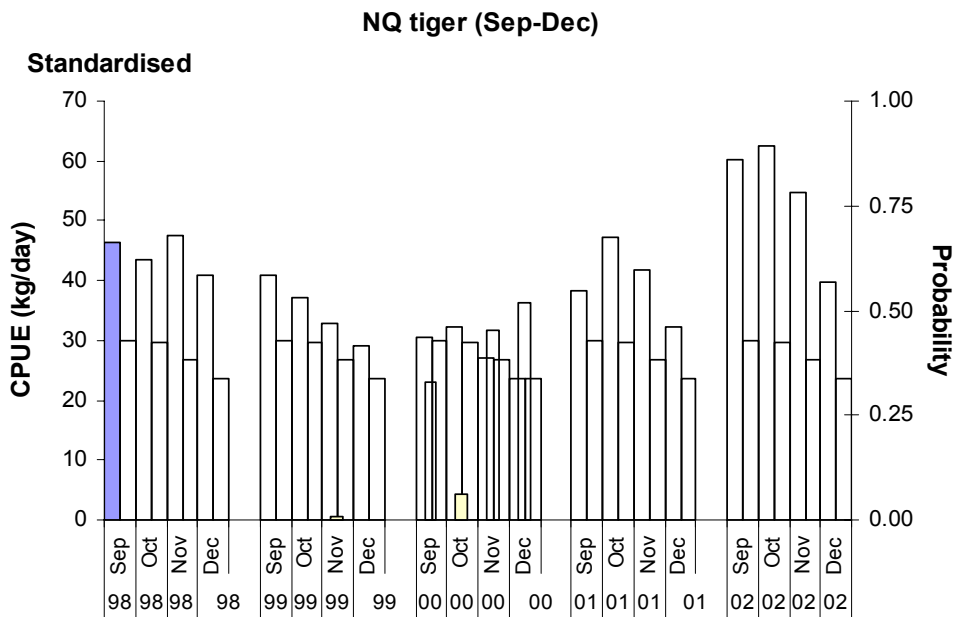

Figure 7.4.32 Comparison of monthly standardised CPUE with 70% CPUE for NQ Tiger (Sep-Dec). A review event was triggered in December 2000 and a 45% probability of triggering a review event in November 2000.

The only trigger month occurred in December 2000 (Figure 7.4.31) with an associated risk of 53, almost double that of the nominal risk (27%) shown in Figure 7.4.31. Catch rates were generally close to trigger points in the Sep–Dec 2000 period. Ignoring October 2000, risk averaged approximately 40%, compared with the average for the period of 23% (Figure 7.4.14).

7.5 DISCUSSION

Several management outcomes may occur depending on how the wording of the East Coast Otter Trawl management plan is interpreted. Suppose that a review event is triggered when nominal or standardised CPUE drops below 70% for two consecutive periods. The following triggers would have occurred in addition to those triggered using the period method of calculating risk probabilities:

- scallop in the 1999–2000 fishing year (Figure 7.4.19 and Figure 7.4.20), although the ‘average’ risk was only 27 and 44% respectively (Figure 7.4.3 and Figure 7.4.4)
- scallop in the 2002–03 fishing year (Figure 7.4.17 and Figure 7.4.18), although the ‘average’ risk was only 21 and 36% respectively (Figure 7.4.1 and Figure 7.4.2)
- the shallow EKP in the 1999–2000 fishing year (Figure 7.4.28), although the ‘average’ risk was only 22% (Figure 7.4.8).

Additionally, CPUE dropped below 70% for only the first two months in 1999–2000 for shallow EKP before rising above the threshold for the rest of the season (Figure 7.4.8). This poses the question, ‘Is a review event required when CPUE rebounds to acceptable levels?’.

There may have just been a late recruitment event for that year, or the result of a pulse of effort at the beginning of the fishing season. Does CPUE have to fall below 70% for a whole season, perhaps? Considering that the logbook data is processed and entered approximately three months behind present this is probably a moot point. It is also important to note that by using the standardised catch-rates all months in the 97–98 fishing season for Scallops triggered a review event (Figure 7.4.18).

Another question that needs to be posed is, what is an acceptable level of risk? This is essentially a management decision. However, for illustration, the risk of falling below 70% average CPUE started at 30%, dropped to 5% and then rose to 45% and then 50% in the Sep–Dec period for the NQ tiger prawn fishery (Figure 7.4.32). Are these acceptable levels of risk (i.e. a 1 in 20 chance (5%) rising to a 1 in 2 chance (50%) of being below 70% average CPUE) considering that the average is only 23% (Figure 7.4.14)? These are the questions that will need to be addressed and decided upon by management. In addition, the validity of employing catch-rate reference points will be addressed in the following chapter.

7.6 REFERENCES

- Beverton, R.J.H. and Holt, S.J. (1957) On the dynamics of exploited fish populations. U.K. Ministry of Agriculture, Fisheries and Food Fishery Investigations (series 2), 19.

8 OBJECTIVE 4. INVESTIGATE AND ESTABLISH ROBUST REFERENCE POINTS AND RESPONSE MECHANISMS THROUGH SIMULATION

8.1 ABSTRACT

A catch rate limit reference point designed to identify over-fishing has recently been implemented for Queensland's eastern king prawn and saucer scallops. It is defined as 70% of the average catch-rate from 1988 to 1997 within the recruitment months of November to February inclusive or the spawning months May to August inclusive. However, this limit reference point has not been validated, and none have been proposed for Torres Strait tiger prawns. We used a monthly delay difference, monthly age-structured and annual surplus production models to test management responses to the triggered reference point of 60%, 70% and 80% of the average catch rate. As well, we examined three model based reference points targeting fishing effort at maximum sustainable yield (E_{MSY}), $3/4 E_{MSY}$ and $2/3 E_{MSY}$. All reference points included variability in natural mortality and annual increases in fishing power. The catch rate reference points result in sustainable levels of fishing, but were not useably valid because they can trigger at high population sizes and caused inappropriate changes in fishing effort. Similarly, catch rates for low population sizes may not necessarily fall below the 70% catch rate trigger. In general, we found that the reference points targeting fishing effort to $2/3 E_{MSY}$ or $3/4 E_{MSY}$ maintained populations slightly above the size that supports maximum sustainable yield. These reference points result in lower risks of under or overfishing, improved catches and higher catch rates. The stock assessments suggest all three stocks (eastern king prawn, Torres Strait tiger prawn and saucer scallop) were fished to the limit sizes that support maximum sustainable yields, but eastern king prawn population sizes prior to 2001 may have been much lower than this. All results were sensitive to the spawner-recruitment relationships that were used and the estimates of annual increases in fishing power. Uncertainty still clouds the ideal reference point for the eastern king prawns, Torres Strait tiger prawns and saucer scallops. This problem remains for most fisheries; reference points depend on our knowing how many prawns or scallops are in the ocean and management having clear target goals for fishing e.g. high catch rates. New types of data are essential to improve the stock assessments, such as spatial indices of abundance collected through fishery independent sampling and vessel monitoring systems (VMS). More accurate and robust reference points may exist using these data, rather than model based reference points. These pieces of information will aid in refining the stock assessment, defining more accurate reference points and strengthening future management decisions.

8.2 INTRODUCTION

Reference points for a fishery can be used as one of the key assessment and management tools to indicate the stage at which a resource is declared to be in some danger of overexploitation or is at an unwanted state. A number of measures, such as catch rates, can be used as reference points, but developing reference points for a particular fishery is complex. Their definition is reliant on detailed analyses and their accuracy depends on data quality and quantity, having a reliable index of population abundance, uncertainties with estimating exploitation rates, and the practicality of monitoring the fishery in relation to the reference points (Hilborn 2002). The type of reference point described above is typically known as a limit. A hypothetical example

of a limit could be if we think that the fishery will be over-fished if the biomass of prawns in the sea drops below 2000 tonnes. The other use of reference points refers to aiming towards a target state of fishing and/or resource that is considered to be desirable. As another hypothetical example, we might believe the fishery will produce the most yield, and most profit for industry, if there were 5000 tonnes of prawns alive in the sea. We would therefore try to manage the fishery to approach this biomass level – our target reference point.

Reference points have been one of the tools used to manage a number of important fisheries throughout the world. In Australia, two examples include restricting fishing effort to achieve maximum sustainable yields in the Australian Northern Prawn Fishery (Dichmont et al. 2001) and in the Queensland Spanner Crab Fishery where annual changes in catch rates are used in decision rules to increase or decrease total allowable catches (Brown et al. 2001). In the Canadian west coast prawn, shrimp and mollusc fisheries reference points have been used to set total allowable catches or fishing effort (Leaman 1993). In most of these fisheries, the reference point used for target fishing was maximum sustainable yield and its associated fishing effort (MSY and E_{MSY}). However, because of the uncertainty surrounding its actual value and its variability from year to year, it has been universally agreed that the MSY reference point is no longer acceptable as a valid fishery target, although it can be accepted as a maximum-limit reference point (Garcia and Staples 2000).

Catch-rate reference points have been used in a number of fisheries, but there has generally been no detailed stock assessment available and their effective performance has been varied. For example catch-rate reference points have been validated for setting total allowable catches in Queensland's spanner crab fishery (Brown et al. 2001). However, the catch-rate reference points used in Australia's South East Fishery have failed because of the lack of relationship between catch rate and population abundance (Punt et al. 2001a). More recently, catch-rate-limit reference points were implemented for prawns and scallops in Queensland's east coast trawl fishery. They are defined as 70% of the average catch-rate from 1988 to 1997 within specified typical recruitment or spawning months for:

- Eastern king prawns — November to February inclusive (recruitment period) and May to August inclusive (spawning period)
- Saucer scallops — November to February inclusive (recruitment period)
- Tiger prawns — March to June inclusive (recruitment period) and September to December inclusive (spawning period).

However, these limit reference points remain to be validated and it is conceivable that it could cause inappropriate changes in fishing effort. To date, no reference points have been specified for the Torres Strait trawl fishery. In addition, with these trawl sectors there are no clear management objectives to set target reference points.

The Queensland, New South Wales, and Torres Strait otter trawl fisheries are particularly important on the east coast of Australia. These fisheries together currently have about 700 licensed vessels, although past numbers operating in Queensland have been as high as 1413 licences in 1980 (Bowen and Hancock 1985). These trawl fisheries catch several species of penaeid prawns (mainly *Penaeus* and *Metapenaeus* spp.), as well as two species of scallop (*Amusium balloti* and *A. pleuronectes*), and can be best described as having a clear suite of target species in specific geographic regions (sectors). The focus of this section of the report is on the Queensland and New

South Wales eastern king prawn (*Penaeus plebejus*), Torres Strait tiger prawn (*Penaeus esculentus*), and Queensland saucer scallop (*Amusium balloti*) trawl sectors. These trawl sectors land a total average catch of about 2500 thousand tonnes of eastern king prawns, 600 tonnes of tiger prawns from the Torres Strait, and 800 tonnes of scallop meat per year, with a landings value in excess of \$30 million, \$8 million, and \$20 million respectively. The Queensland Fisheries Service (QFS) and the New South Wales Fisheries Department both manage the eastern king prawn sector independently within each state, although the trawl sector is widely considered to be based on a single stock. The QFS and the Australian Fisheries Management Authority (AFMA) jointly manage the Torres Strait trawl fishery, and the QFS manages the Queensland's scallop sector. A range of management input controls on these trawl sectors are used, including: limited entry, boat-nights allocation, gear size, and spatial and seasonal closures. Despite these restrictions, Australia's east coast trawl stocks, in particular, are subject to perceived heavy fishing effort that may not be sustainable or optimised for value in the long term.

Early assessments of eastern king prawns have mostly been limited to simple interpretations of trends in catch-per-unit effort statistics. However, three equilibrium yield-per-recruit analyses and one monthly surplus production analysis were completed between 1974 and 1999. The first analysis suggested that a 25% increase in fishing effort in Queensland offshore waters would result in a corresponding increase in eastern king prawn catch and only a small reduction in the catch per boat (Lucas 1974). The second analysis suggested that limited benefits in terms of yield would eventuate from substantial increases in fishing effort but that substantial decreases in catch rates were likely (Glaister et al. 1990). The third analysis used an enhanced spatial compartmental yield-per-recruit model for the eastern king prawn fishery in New South Wales (Gordon et al. 1995). However, parameters estimated from this analysis were used only to show reduced yields if Botany Bay was closed to trawling. It must be highlighted that all three yield-per-recruit analyses take into account only prawn growth and mortality. Variation in stock-recruitment was not included and catches taken from the whole sector were not considered. The consequence of these restrictions is that recruitment over-fishing cannot be detected. The fourth analysis was not restricted to the equilibrium assumptions above and used eastern king prawn catches from the whole sector in Queensland and New South Wales waters; stable indices of recruitment and population size were estimated, but no comments on stock status or management were made (Dichmont et al. 1999).

Early assessment of tiger prawn stocks in the Torres Strait was based on estimation of the Maximum Constant Yield (MCY) produced by QDPI in 1991 (Turnbull and Watson 1995). Research trawl data collected during the years 1986 to 1989 were used to calculate an MCY for each species. The definition of MCY is the maximum constant catch that is estimated to be sustainable, with an acceptable level of risk, at all future levels of biomass. The MCY for the fishery was estimated to be 1370 t, consisting of 585 t tiger prawns, 685 t endeavour prawns and 100 t king prawns. A summary of this assessment, 1992 Fishery Status Report for Torres Strait Prawns, is contained in (Turnbull and Watson 1995). The second formal stock assessment was conducted in 1994 and is described in detail in (Turnbull and Watson 1995). That assessment showed that a natural mortality of 0.2 per month (the value used in the 1991 assessment and widely reported in the literature) will produce an MCY for the fishery of 1903 t, consisting of: 682 t tiger prawns, 1035 t endeavour prawns, and

186 t king prawns. The 1991, 1992 and 1995–1999 catches were close to this estimated MCY. In both assessments MCY was estimated using the technique advocated for a developed fishery with historic estimates of biomass:

$$\text{MCY} = 0.5 \times F_{0.1} \times B_{\text{avg}} \text{ (Annala 1993).}$$

where B_{avg} is the average recruited biomass of the fishery and the fishery is believed to have been fully exploited. This formulation assumed that $F_{0.1}$ approximates the average productivity of the stock. Logbook data for the years 1989 to 1992 were used to define the extent of the fishery. SPANS Geographic Information Systems software was used to estimate B_{avg} from monthly trawl research surveys conducted from 1986 to 2001. The annual $F_{0.1}$ for each species and sex was calculated using a simple BASIC program (Hilborn and Walters 1992). This program used estimates of the growth, length-weight relationships and gear selectivity parameters. Estimates of the effort required to produce an annual fishing mortality equal to $F_{0.1}$ were 106,400 hours (88 700–133 300 h) for catchability estimates of $2.5 \times 10^{-5} \text{ h}^{-1}$ ($2 \times 10^{-5} - 3 \times 10^{-5} \text{ h}^{-1}$). These equate to 9900 (8200–12 400) unstandardised days, as the average number of hours trawled per night in Torres Strait during the years 1998–2002 was 10.8.

Management and historical assessments of saucer scallops have mainly focused on the use of minimum legal sizes and spatial closures to maintain spawner stock levels. Historical assessments have generally been restricted to optimising size limits to maximise yield-per-recruit. Initial results suggested shell heights of between 82 mm and 90 mm, with an 85 mm minimum legal size adopted in 1985 (Dredge 1985b); (Dredge 1994). As fishing effort directed at saucer scallops increased and catch rates fell, management introduced a variable size limit of 90 mm in summer and autumn and 95 mm in winter and spring (Dredge 1994). Spawner and value per-recruit analyses were run in 1994 to investigate other possible minimum legal size limits. The results indicated that increasing the size limit to 95 mm throughout the year would increase spawners per recruit minimally while decreasing value per-recruit 15–20% (Dredge 1994). In 1996–1997, catch rates fell to very low levels and there were concerns about potential recruitment overfishing (Dredge 1988); (Dichmont et al. 1999), which led to the introduction of three 10'×10' minute spatial closures to maintain spawner levels. Population assessments since 1997 have been based on reviews on commercial catch and effort statistics and data derived from an annual fishery-independent recruitment survey (Dichmont et al. 2000). An alternative profit maximisation model was developed in 1998 to optimise minimum legal sizes and rotational opening and closing of fishing areas, but no practical recommendations were made from outputs of this analysis (Kozan and Sier 1999). An age-structured stock assessment was conducted in 1998 and was not restricted to the per-recruit equilibrium assumptions above (Dichmont et al. 1999). The results confirmed that high recruitment occurred in the calendar year of 1992 and declined to historically low levels in 1996 (Dichmont et al. 1999). The slight recovery of recruitment in 1997 was debateable, given the analysis was based on unstandardised catch-rates (Dichmont et al. 1999). No other comments on stock status or management were made.

Until now, there has been no research into the validity of catch-rate reference points in terms of their relationship to resource sustainability of eastern king prawns or saucer scallops on the east coast of Australia, or tiger prawns in the Torres Strait. In this report we used simulation modelling to investigate the performance of catch-rate reference points. Simulation models have been used internationally to investigate and

develop appropriate reference points that can be applied to the particular resources and fisheries needs (Punt et al. 2001a). These models can supply quantifiable definitions for reference points and also test which of these are appropriate for the resource and management. This report shows that catch rate reference points are not an accurate tool for managing prawns and scallops, and that alternative fishing mortality reference points would perform better to achieve any defined management objectives. Note, when comparing simulations, less weight should be given to results from the surplus production models; their parameters are hard to associate precisely with observable biological processes (especially for penaeid prawn with a short life history of one to two years), and they do not accurately measure variations in recruitment.

8.3 METHODS

8.3.1 *Catch and Effort Data*

Catch and effort records for each species were extracted from their relevant logbook databases. These data were then analysed to calculate average standardised catch rates for use in the stock assessment modelling. The following rules were used to extract data on each species:

Eastern King Prawns

Queensland eastern king prawn catches and fishing effort were retrieved from the Queensland Fisheries Service QFISH database. First, all trawl catches were extracted using the standard trawl SQL code titled 'dump 9A'. From this trawl data, the Standing Committee for Fisheries and Aquaculture (SCFA) business rules for Environment Australia (EA) were applied. This included removing all beam trawling data (fishing method 47). Eastern king prawn catches were then extracted south of -22 degrees inclusive, plus east of 152.5 degrees inclusive between -21 and -22 degrees to include the Swain Reefs catches. All catches from Moreton Bay were excluded (i.e. logbook grids 'w37' and 'w38' were removed). This was because of the multi-species nature of prawn trawling in Moreton Bay and the non-specific way that fishers record their prawn catches. Also, eastern king prawns in Moreton Bay are usually all pre-recruits to the offshore fishery (i.e. mostly less than 25 mm carapace length). The assessment model only relates to prawns first recruiting to the offshore fishery (i.e. prawns greater than about 26 mm carapace length). Eastern king prawns were defined by the following species codes 701000, 701304, 701904, 701907, 701927, and 701915. Queensland logbook grids with the latitude labels 40 and 41 were not included as they overlap with New South Wales logbooks (i.e. Y40, Y41, X40 and X41). For the catch-rate-standardisation only, all bulk data (landings without associated recorded trawling effort) were excluded (represents about 1% of catches). The fishing-year for eastern king prawns was defined as starting in November and ending in October, to match the cycle of fishing and recruitment to the fishery (Courtney et al. 1995).

New South Wales (NSW) catches were collated for all eastern king prawn landings taken from only ocean prawn trawling. The NSW commercial catch records manager supplied these data. Monthly eastern king prawn catches for each trawler were

extracted separately using the species code 701915. The number of fishing days were based on the monthly total recorded by vessels that reported eastern king prawns.

Torres Strait Tiger Prawns

Three data sources were used to compile the available time-series of tiger prawn catches in the Torres Strait. The first data source was the 1978 to 1988 monthly unloading catch-statistics recorded by the Northern Fisheries Unit (a Commonwealth Authority). The second data source was the daily logbook catches provided by part of the fleet for the years 1980–1988. During these years all Northern Prawn Fishery endorsed vessels were required to record catch and effort whilst in the NPF and Torres Strait Fisheries. In addition, some dual Torres Strait and Queensland east coast endorsed vessels voluntarily filled out the NPF logbook whilst fishing in Torres Strait. These data provide catch rates of tiger prawns for the years 1980 to 1988. The third source was the compulsory daily logbook catches recorded from 1989 to 2002. This data was collected as part of the AFMA logbook program and provided both tiger prawn total catches and catch rates.

All Torres Strait prawn catches from 1989 to 2002 were downloaded from the AFMA vessel operation and species catch tables. These data were then loaded into Microsoft Access and range checks performed to identify and correct outlying large catches. A cross tab query was then used to combine the operation and catch data in a single table of daily vessel catches of each prawn species. Tiger prawn catches were defined by the species code 27701900 in the AFMA database. There was a very small amount of tiger prawn catch recorded under the general prawn code, 27701000. This code, however, represented less than 0.4% of all prawn catches taken in the Torres Strait and was not used. The data were also coded into two regions by latitude, north (greater than or equal to -9 degrees and less than -10 degrees) and south (greater than or equal to -10 degrees and less than -11 degrees). This stratification was based on the information that catches in the southern area have a higher proportion of endeavour prawns and a lower tiger prawn catch rate. The small number of daily records with zero catches for tiger prawns (636 records; $< 0.5\%$ of records) and position locations south of -11 degrees outside of the Torres Strait fishery (19 records) were excluded from the data. For tiger prawns, a calendar year was viewed as suitable for a fishing-year.

Saucer Scallops

Again as with eastern king prawns, all Queensland trawl catches were extracted using the standard trawl SQL code, titled 'dump 9A'. The SCFA/EA rules were then applied where all scallop catches were extracted south of -22 degrees inclusive (Dichmont et al. 1999). These latitudinal ranges were chosen to minimize the mixture of mud scallop in catches that can occur north of -22.5 degrees. The spatial logbook-grids that relate to the specific saucer scallop fishery, where most of catch and trawling effort occurs, are 'S28', 'T28', 'S29', 'T29', 'T30', 'U30', 'U31', 'V31' and 'V32'. Again, all beam trawl data were removed. Saucer scallop catches were defined by the species code 900200 and 900204. For catch rate standardisation all bulk data were excluded due to the lack of information on fishing effort and locations. The fishing-year for saucer scallops was defined from November through to October and based on

information about the life cycle, size at recruitment and the seasonal variation in fishing effort.

8.3.2 Standardisation of Catch Rates

Eastern King Prawns

The process of standardising eastern king prawn catch-rates was different from that for the Torres Strait tiger prawn and scallop sectors. A formal statistical analysis of the combined Queensland and New South Wales data was not viewed as beneficial due to the different commercial catch recording processes between states (daily in Queensland and monthly in New South Wales). Instead, the standardisation process involved calculating a weighted average catch rate (kilograms of prawns per boat night) based on the number of standardised days fished in each state. This weighting was applied as the spatial area of this sector in Queensland and New South Wales waters is similar, and so weighting the catch rates by effort is adequate. The numbers of standardised days were calculated by multiplying the reported number of boat days in each fishing year and month by the average annual changes in fishing power. The overall average annual change in fishing power for the combined Queensland and New South Wales sectors was assumed to be the weighted average between the deep and shallow water estimates (Table 8.3.2.1).

Table 8.3.2.1 The weightings used to calculate average fishing power increases for Queensland and New South Wales. Weightings for shallow waters were based on summing fishing effort across New South Wales, the Queensland logbook grids classified as having water depths less than 50 fathoms and half of the Queensland fishing effort that could not be clearly classified as either deep or shallow waters. The deep water weighting were derived by summing fishing effort across the Queensland logbook grids classified as having water depths greater than 50 fathoms and half of the Queensland fishing effort that could not be clearly classified as either deep or shallow waters.

Eastern King Prawn Fishing Year	Proportion of Fishing in Deep Waters	Proportion of fishing in Shallow Waters
1989	0.1796	0.8204
1990	0.1877	0.8123
1991	0.2032	0.7968
1992	0.2071	0.7929
1993	0.2096	0.7904
1994	0.2161	0.7839
1995	0.2386	0.7614
1996	0.2251	0.7749
1997	0.2385	0.7615
1998	0.2449	0.7551
1999	0.2151	0.7849
2000	0.2416	0.7584

Torres Strait Tiger Prawns

The process of standardising tiger prawn catch rates in the Torres Strait was similar to that used by (Haddon and Hodgson 2000) for Australia's Northern Prawn Fishery. We analysed catches of tiger prawns using a general linear model (GLM) with normally distributed errors on the natural log scale. The response variable was based on individual vessel daily catches of tiger prawns. Spatial variations in catches were allowed for in two areas, north and south of 10°S, split on the basis of species composition of the catch, the average catch rates of tiger prawns and amount of fishing effort. The analysis also included parameters to account for variations in tiger

prawn catches due to lunar phases, part or full night fishing and associated endeavour prawn catches. The statistical software Genstat 6 was used to carry out the estimation by least squares, and provide standard errors for all estimates (Genstat 2002). The Genstat procedure 'Select' was used to confirm the final model structure using Akaike's information criterion. The components used to standardise catch rates were as follows:

- Tiger prawn catches – kilograms per boat per night per region.
- Calendar years – factor levels coded as years from 1980 to 2002.
- Month – factor level coded January to December.
- Region – factor level coded for two regions as described above.
- Lunar – factor level coded new, making, full and waning moons.
- Pnite – factor level coded 1 for a full night's fishing and 0 for a part night.
- Endeavour – endeavor prawn catch (kgs +1) per boat per night per region.
- Fishing power – vessel, fishing gear and technology changes as calculated in the previous fishing power chapter.

Additive or interaction effects between the year and month model terms alternated for predicting annual or monthly catch rates respectively. All predicted catch rates were for a full night's fishing (i.e. Pnite = 1), for a median (geometric mean) endeavor catch (~83 kg), and standardised by averaging over the regions and lunar phases for a 1980 equivalent average fishing power.

Saucer Scallops

Catches of scallops were analysed using a general linear model in the same way as Torres Strait tiger prawns. The response variable was the number of scallops caught per vessel per night, so that average catch rates were conveniently transferable into the age-structured stock assessment model. This nightly catch was the product of converting from baskets of scallop to shell numbers (based on 500 scallops per baskets (Dichmont et al. 1999)). The spatial scale of the analysis used the 30 × 30 minute logbook grids. The analysis also allowed for catch variations due to lunar phases. The statistical software Genstat 6 was again used to carry out the estimation. The components used to standardise catch rates were as follows:

- scallop – scallop catch (shell numbers) per boat per night per logbook grid.
- fishing_year – factor level coded from 1989 to 2002.
- month – factor level coded November through to October.
- lunar – factor level coded new, making, full and waning moons.
- grid – factor level coded for the 30 minute logbook grids.
- Fishing power – vessel, fishing gear and technology changes as calculated in the previous fishing power chapter.

Additive or interaction effects between the year and month model terms alternated for predicting fishing-year or monthly catch rates respectively. All predicted catch rates represented a standardised 1989 vessel, fishing within an average logbook grid and lunar phase.

8.3.3 Delay Difference Modelling

The Deriso-Schnute delay difference model was used in this study to assess the eastern king prawn and Torres Strait's tiger prawn trawl sectors (Deriso 1980; Dichmont et al. 2001; Quinn and Deriso 1999; Schnute 1985). The model simplified the mathematics of population age structures so that population biomass followed a single delay difference equation, and prawn growth was approximated by the Brody growth curve. The model analysed the available time-series of standardised monthly-catch-rates to estimate harvest rates and therefore calculate monthly population biomass and numbers of prawns. This model captured the monthly dynamics of the prawn population, the seasonality of the fishery, and estimated spawning and recruitment trends. It contained biologically meaningful parameters for prawn growth, natural mortality, and recruitment and allowed realistic variations in these parameters. The model also allowed for some of these parameters to be estimated directly from standardised catch rate (relative abundance) data.

The dynamics of the delay difference model followed equations (1) and (2) which described the biomass (B) and numbers (N) of prawns alive at the start of month t (Table 8.3.3.1). In these equations, monthly recruitment was calculated by the product of the within fishing year recruitment pattern (equation 4) and the total number of prawns recruiting in the fishing year ($N_{r,y}$) (Dichmont et al. 1999). The growth of prawns older than the recruitment age of three months (r) was approximated by the Brody curve (equation 3). The value of ρ was estimated by fitting the growth equation to the sexes-combined von Bertalanffy average growth curve ((Die et al. 1999), and (Glaister et al. 1987); see data section). Once the time series of prawn biomass and number of prawns were calculated, monthly total catch and catch rates were predicted using equations (6) and (7). The spawning index of female prawns in each fishing year was approximated using the within-year spawning pattern and half the effective number of prawns alive each fishing-year (equation 8).

Table 8.3.3.1 The equations defining the delay-difference modelling for eastern king and tiger prawns.

Equation	Population Dynamics: Monthly Delay Difference	Notation
	Exploitable Biomass: B_t (kgs)	
(1)	$B_t = (1 + \rho)e^{-Z_{t-1}} B_{t-1} - \rho e^{-Z_{t-1}} e^{-Z_{t-2}} B_{t-2}$ $- \rho e^{-Z_{t-1}} w_{r-1} p_t N_{r,y} + w_r p_t N_{r,y}$ <p>Exploitable Numbers N_t</p>	<p>t: sequential monthly time step across the fishing years.</p> <p>e: exponential function</p> <p>ρ: prawn growth parameter.</p> <p>Z_{t-1}: Total Mortality in the month $t-1$.</p> <p>Z_{t-2}: Total Mortality in the month $t-2$.</p>
(2)	$N_t = N_{t-1} e^{-Z_{t-1}} + p_t N_{r,y}$ <p>Average weight of prawns older than recruitment age three months.</p>	<p>w_r: average weight (kg) of a prawn at recruitment age to the fishery (three months for eastern king prawns and five months for tiger prawns).</p>
(3)	$w_t = (1 + \rho)w_{t-1} - \rho w_{t-2}$ <p>Recruitment pattern: monthly proportion of annual recruits p_t:</p>	<p>w_{r-t}: average weight of a prawn one month before it enters the fishery.</p>
(4)	$p_t = e^{\left(\frac{-(m_t - \mu_r)^2}{2\sigma_r^2} \right)^{\theta_r}}; p_t = \frac{p_t}{\sum p_t}$	<p>$N_{r,y}$: estimated number of newly recruited prawns in fishing year y ($N_{r,y} = R_y$). $m_t = 1, 2, \dots, 12$ months, where the first month is November and the twelfth month is October for king prawns and the first month is January and the twelfth month is December for tiger prawns. μ_r, θ_r, and σ_r were respectively the estimated mean, slope and variance parameters of the annual recruitment pattern.</p> <p>p_t: sums to one in each fishing year.</p>
	Monthly Total Mortality Z_t	
(5)	$Z_t = M + F_t$ <p>where $F_t = qE_t$ for eastern king prawns, and</p> $F_t = -\log_e \left(1 - \frac{C_t}{B_t} \right)$ for tiger prawns (Haddon 2001).	<p>M: 0.2 monthly instantaneous rate of natural mortality for both prawns.</p> <p>F_t: instantaneous fishing mortality.</p> <p>q: catchability coefficient.</p> <p>E_t: number of standardized fishing days.</p> <p>C_t: observed monthly catch kgs.</p>
	Predicted Monthly Catch C_t kgs	
(6)	$\hat{C}_t = \frac{qE_t}{Z_t} B_t (1 - e^{-Z_t})$	<p>B_t was replaced with N_t to calculated catch in numbers of prawns.</p>
(7)	Predicted monthly catch rate:	
	$\hat{cpue}_t = qB_t$	
	Approximate annual female prawns spawning S_y	
(8)	$S_y = 0.5 \sum_{t=1}^{12} \beta_t \frac{1 - e^{-Z_t}}{Z_t} N_t$	<p>β_t: vector of monthly spawning patterns (sum of proportions normalized to one), where $t = 1$ is the first month of the fishing year and $t = 12$ the last month.</p>

In total 16 and 27 parameters (q , μ_r , θ_r , σ_r and $N_{r,y}$) were estimated in the eastern king prawn and Torres Strait tiger prawn analyses, respectively. The eastern king prawn modelling used standardised catch rates from September 1988 to March 2001. The tiger prawn analysis used standardised catch rates from January 1980 to December 2002. Initial biomasses in the first two months of the time-series analysed were calculated based on the relationship $B = cpue / q$ (Hilborn and Walters 1992). The ‘fminsearch’ MATLAB simplex search routine was used to carry out the estimation by maximum likelihood (MATLAB 2002). The following algorithm was used:

1. Set initial parameter values of catchability (q) from a surplus production model, recruitment-pattern parameters (μ_r , θ_r , and σ_r) to match the within-fishing year average catch rate trend, and annual number of prawn recruits to equal the average fishing year catch divided by the average prawn recruitment weight. This step required some work to initialise starting parameter values. Altering the scale of the starting recruitment estimates and monitoring the log-likelihood narrowed down the initial starting values.
2. Calculate monthly biomass and prawn numbers using equations (1) and (2).
3. Predict the monthly catch rate using equation (7).

4. Compute the negative normal log-likelihood of the data using:

$$-\log \ell = \frac{n}{2} \left(\log(2\pi) + 2 \log \left(\text{sqr}t \left(\frac{1}{n} \sum_i \left(\log \left(cpue_i \right) - \log \left(\hat{cpue}_i \right) \right)^2 \right) \right) + 1 \right),$$

where n was number of observed catch rates, π is 3.14159, \log is the natural logarithm function, $\text{sqr}t$ is the square root function and $cpue$ was the monthly standardised catch rate and \hat{cpue} was the predicted catch rate.

To ensure exploitation rates ranged between zero and one, and to avoid the optimisation converging to unrealistically large population sizes with low improbable estimates of exploitation, two additional penalty terms were examined to test their influence on the minimisation. The first penalty function λ_1 ensured the observed catch in each month did not exceed the calculated exploitable biomass:

$$\lambda_1 = \begin{cases} 0 & \text{if } (C_t \leq B_t) \\ \sum (C_t - B)^2 & \text{otherwise} \end{cases}.$$

The second penalty function λ_2 prevented extremely low exploitation rates:

$$\lambda_2 = \begin{cases} 0 & \text{if } \frac{CN_y}{R_y} \geq h \\ 1000 \left(h - \frac{CN_y}{R_y} \right)^2 & \text{otherwise} \end{cases} \quad (\text{Hall and Watson 2000}),$$

where h was the minimum annual harvest fraction, CN_y were the accumulated number of prawns caught across the fishing years (Table 8.3.3.1), and the value 1000 was used to ensure adequate weighting in the optimisation. Three values of 0.2, 0.1, and 0.01 for h were tested as informative priors.

5. Minimise negative log-likelihood by changing the parameter estimates using the simplex iteration method. Note that contrast in fishing effort between months is required in order to estimate q .

Once convergence was achieved, alternative initial parameter estimates were tested to ensure accurate maximum likelihood. The penalty functions examined resulted in zero influence on parameter estimates.

The main assumptions of the delay difference analyses were:

- Standardised catch rate is proportional to abundance.
- Constant natural mortality and catchability.
- Average prawn growth.
- Age at first recruitment to the fisheries were three months for eastern king prawns and five months for tiger prawns. All post-recruitment size classes were equally vulnerable to fishing.
- Accurate reporting of the commercial catches.

8.3.4 Age Structured Modelling

An age-structured biomass model was used to calculate monthly population biomass and numbers of Saucer Scallop. This model was first documented within the Proceedings of the south-east Queensland Stock Assessment Workshop 1998 (Dichmont et al. 1999), and has been considerably enhanced to calculate and simulate reference points. The model used an age structured approach that considered the survival of 1,2,...,48 month old scallop and allowed for the change in size selectivity throughout the year. It also incorporated fishery independent survey estimates of scallop numbers (provided by the QFS Long-Term Monitoring Program in 2002; see also (Jebreen et al. 2003)).

The population dynamics were assumed to follow the standard Baranov equations (Quinn and Deriso 1999). The initial number of scallops for age one month in November 1988 was:

$$N_{1988,11,1} = \Phi_1 \hat{R}_{1989}$$

where $N_{1988,11,1}$ was the scallop population in year 1988 for the month of November of age one month, \hat{R}_{1989} was the estimated recruitment for the fishing-year 1989, and Φ_1 was the birth pattern for November (described later as the ‘recruitment pattern’).

Initial numbers of scallop in November 1988 for ages two to 48 months were calculated as follows:

$$N_{1988,11,a} = \hat{R}_{av} \Phi_m e^{-(\mathbf{M}(a-1)+SF)}$$

where $N_{1988,11,a}$ was the total scallop numbers in year 1988 for November age a , \hat{R}_{av} was the estimated average recruitment for the fishing-years 1985 to 1988, Φ_m was the vector of birth patterns for each cohort occurring up to the previous 47 months m , \mathbf{M} was the vector of assumed average monthly natural mortality for each cohort up to the previous 47 months, S was the selectivity by age for each cohort up to the previous 47 months, and F_{av} was an assumed historic average fishing mortality using equivalent to October 1988 fishing effort. This tailored approach of calculating initial

numbers was tested and concluded to be robust, and avoided assuming the starting 1989 stock size was at an unexploited state (Dichmont et al. 1999).

The age-structured time dynamic calculations after November 1988 followed the equations:

$$N_{y,m,a} = \begin{cases} R_y \Phi_m & \text{for } a = 1 \\ N_{y,m-1,a-1} e^{-M} (1 - S_{m-1,a-1} P_{adj} F_{y,m-1}) & \text{for } a = 2..48 \end{cases}$$

where R_y were the estimated annual recruitments for the fishing-years 1989 to 2001, $S_{m,a}$ was the selectivity by age and month, which included the change in minimum legal size over the fishing-year, and P_{adj} was the proportional adjustment of fishing mortality calculated using the Long-Term Monitoring Program estimates of scallop numbers \hat{N} within the fishery and closures from 1997 to 2000:

$$P_{adj,y,a} = \begin{cases} \hat{N}_{0+,y,fishery} / (\hat{N}_{0+,y,fishery} + \hat{N}_{0+,y,closures}) & \text{for } a = 1..11 \\ \hat{N}_{1+,y,fishery} / (\hat{N}_{1+,y,fishery} + \hat{N}_{1+,y,closures}) & \text{for } a = 12..48 \end{cases}$$

where P_{adj} prior to February 1997 = 1 (i.e. no closures), $P_{adj,2001}$ assumed = $P_{adj,2000}$, the symbols 0+ represents recruitment within the fishing year and 1+ represents ages classes one year and older (Jebreen et al 2003).

The recruitment pattern Φ_m , referred to above as the vector of birth patterns, represents the proportion of annual recruits in each month m , and was calculated by the following equation:

$$\Phi_m = e^{\left(\frac{-(m - \mu_r)^2}{2\sigma_r^2} \right)^{\theta_r}}$$

where μ_r , θ_r , and σ_r were recruitment parameters to be estimated. The resulting pattern was normalised to 1 ($\Phi_m / \sum \Phi_m$).

Monthly instantaneous fishing mortality F , for year y and month m , was calculated as $F_{y,m} = qE_{y,m}$, where q was the estimated catchability coefficient and $E_{y,m}$ were the standardised number of days fished in fishing-year y , and month m .

The fishing selectivity $S_{m,a}$ was not assumed to be knife-edge and was smoothed with a 10% standard deviation on both the 90 mm and 95 mm minimum commercial legal sizes. The selectivity vector for the 90 mm minimum commercial legal size across all ages a was given by

$$S_a = [\max(\text{normcdf}(L_{a=1..7}, 87.6, 8.8), 0) \max(\text{normcdf}(L_{a=8..48}, 87.6, 8.8), 1)],$$

and for the 95 mm minimum commercial legal size by

$$S_a = [\max(\text{normcdf}(L_{a=1..9}, 92.5, 9.3), 0) \max(\text{normcdf}(L_{a=10..48}, 92.5, 9.3), 1)],$$

where \max was a Matlab function to return the largest elements of the array, normcdf function computed the normal cumulative distribution function (cdf) at each of the average scallop shell height sizes at age using the corresponding minimum legal shell height size and 10% standard deviation, and L_a was the average scallop shell height at age calculated using a von Bertalanffy growth curve.

The mid-month exploitable numbers of scallop were calculated as:

$$EN_{y,m} = \sum_a S_{m,a} P_{adj} N_{y,m,a} - \frac{C_{y,m}}{2},$$

where $C_{y,m}$ was the number of scallops caught in each fishing-year y , and month m .

Catch-per-unit effort was calculated as:

$$\hat{cpue}_{y,m} = qEN_{y,m}$$

The exploitable biomass at the start of each month was:

$$B_{y,m} = \sum_a N_{y,m,a} P_{adj} S_{m,a} w_a,$$

where w_a was the average scallop weight at age (units in kilograms).

The model estimate of monthly catch (in tonnes) was given by:

$$C_{y,m} = \frac{F_{y,m}}{F_{y,m} + M} B_{y,m} (1 - e^{-F_{y,m} - M})$$

The spawning index of female scallops in each fishing-year was approximated using the within year spawning pattern β_t , maturity (mat) and fecundity ($fecund$) at age, and half the effective number of scallops alive each fishing-year:

$$S_y = \sum_{t=November}^{October} \beta_t \frac{1 - e^{-Z_t}}{Z_t} \sum_a 0.5 N_{t,a} mat_a fecund_a.$$

In total 18 parameters (q , μ_r , θ_r , σ_r and R_y) were estimated in the Saucer Scallop analysis. The modelling used monthly-standardised catch rates from November 1988 to December 2001 and four fishery independent population estimates from the month of October for the years 1997 to 2000. The 'fminsearch' MATLAB simplex search routine was used to carry out the estimation by maximum likelihood (MATLAB 2002). The following algorithm was used:

1. Set initial parameter estimates of catchability (q) from a surplus production model, recruitment-pattern parameters (μ_r , θ_r , and σ_r) to match the within fishing year average catch rate trend, annual number of scallop recruits to equal the average fishing year catch. This step was an iterative process and commenced by arbitrarily setting initial parameter values. Altering the scale of the starting recruitment estimates and monitoring the log-likelihood narrowed down the initial starting parameter values.
2. Calculate monthly scallop numbers.
3. Predict the monthly catch rate.
4. Compute the negative normal log-likelihood by adding:

$$-\log \ell_c = \frac{n}{2} \left(\log(2\pi) + 2 \log \left(\text{sqr}t \left(\frac{1}{n} \sum_i \left(\log \left(\text{cpue}_i \right) - \log \left(\widehat{\text{cpue}}_i \right) \right)^2 \right) \right) + 1 \right) \quad \text{for the}$$

catch rate data, where n was number of monthly catch rates, π is 3.14159, \log is the natural logarithm function, $\text{sqr}t$ is the square root function and cpue was the monthly standardised catch rate and $\widehat{\text{cpue}}$ was the predicted catch rate, and

$$-\log \ell_s = \frac{n}{2} \left(\log(2\pi) + 2 \log \left(\text{sqr}t \left(\frac{1}{n_{1997 \dots 2000,10}} \sum \left(\log \left(NS_{y,10} \right) - \log \left(\sum_a N_{y,10,a} \right) \right)^2 \right) \right) + 1 \right)$$

for the independent survey estimates of population size (NS).

To ensure exploitation rates ranged between zero and one, and to avoid the optimisation converging to unrealistically large population sizes with low improbable estimates of exploitation, the two additional penalty terms as outlined in the prawn delay difference analysis were examined (section 8.3.3, page 14–15). The three values of 0.2, 0.1 and 0.01 were again tested for h as informative priors.

5. Minimise negative log-likelihood by changing the parameter estimates using the simplex iteration method.

Once convergence was achieved, alternative initial parameter estimates were tested to ensure the likelihood was not at local maxima. The penalty terms examined resulted in zero influence on parameter estimates.

The main assumptions of the age-structured analyses were:

- Standardised catch rate is proportional to abundance.
- Constant natural mortality and catchability.
- Average scallop growth.
- Accurate reporting of commercial catches.

8.3.5 Surplus Production Modelling

The simplest time dynamic fisheries population models are those that consider only a single indicator of population size, usually biomass. These models ignore age or size structure and do not explicitly consider growth and recruitment. They are called biomass dynamic (or surplus production) models and take several variations on the traditional logistic models of ecology. The most commonly used of these is the Schaefer form of the surplus production model. Only three main parameters are to be estimated which makes it simple and convenient to apply. These are the intrinsic population growth rate (r), the population carrying capacity (K ; virgin stock size) and catchability coefficient (q). This model is well described by (Punt 1993), (Prager 1994) and (Haddon 2001), and relies on the standardised catch per unit effort index being proportional to the trend in stock abundance.

A non-equilibrium logistic (Schaefer) surplus production model gave the best fit to the catch rate data for eastern king prawn and saucer scallops. Other forms such as the Pella-Tomlinson and Fox models were applied but failed to generate realistic parameter values for these stocks. The Fox production model (results were equivalent to the Pella production model) provided a better optimal description of the Torres

Strait tiger prawns compared to the Schaefer model. The eastern king prawn and scallop modelling used standardised catch rates from the fishing years 1989 to 2001. The tiger prawn analysis used standardised catch rates from the 1980 to 2002 fishing years.

Population biomass was calculated according to the simple function:

$$B_{t+1} = B_t + f(B_t) - C_t,$$

where $f(B_t) = rB_t \left(1 - \frac{B_t}{K}\right)$ was the Schaefer form and

$f(B_t) = \log_e(K)rB_t \left(1 - \frac{\log_e(B_t)}{\log_e(K)}\right)$ was the Fox form of surplus production, B_{t+1} was

the (exploitable) biomass at the start of fishing year $t+1$, r was the intrinsic rate of population growth, K was the average unexploited equilibrium biomass (carrying capacity) and C_t was the observed catch during fishing year t . Initial biomass in the first fishing year was calculated based on the relationship $B = cpue/q$ (Hilborn and Walters 1992).

Standardised catch per unit effort data was used as an index to estimate biomass through $\hat{cpue}_t = qB_t$.

To apply the production models both observed and predicted catch rates were natural log transformed. Parameter estimates were found by minimising the negative log-likelihood:

$$-\log \ell = \frac{(n-1)}{2} (\log_e(2\pi) + 2\log_e(\hat{\sigma}) + 1) + LLpen,$$

where n was the number of fishing years in the catch rate time-series,

$$\hat{\sigma} = \sqrt{\sum_t \frac{\left(\log_e(cpue_t) - \log_e(\hat{cpue}_t)\right)^2}{n-1}} \quad \text{and, } LLpen \text{ was a penalising term to}$$

minimise the probability that the starting biomass B_1 was greater than carrying capacity K . The simplex minimising method in MATLAB (fminsearch) was used in the estimation procedure.

8.3.6 Statistical Uncertainty in Models

In the previous sections, the methods for fitting three stock assessment models to estimate biological parameters were outlined. This section describes the statistics used for measuring the goodness of fit of each model, measuring the precision of the parameters estimated, and calculating the confidence intervals.

Having modelled the particular stock, the parameters estimated were assessed against their relative precision to ensure the model was appropriate for the data. Parameter estimates were the values that maximised the log-likelihood of the model for the data observed. If the parameter estimates described the data well, their level of precision was assumed to be high. The resulting log-likelihood was greater compared with a

less appropriate model's log-likelihood considered against the number of parameters in each model. The objective was for the fitted model to have an appropriate combination of parameters and a reliable level of accuracy in order to make predictions of management quantities, and inferences on management strategies and reference points. The discrepancy between the predicted catch rates and the observed was measured and a decision was made on whether the discrepancy was acceptable or not. This discrepancy was the measure of statistical uncertainty. Other types of uncertainty regarding the appropriateness of the model's framework (model uncertainty), the fixing of certain biological parameters (conditioning uncertainty) and the behaviour of the models performing only to the average situation (process uncertainty) are dealt with later in the simulation framework.

A range of statistics plots was used to measure the goodness of fit (statistical uncertainty) between the observed standardised catch rates and those predicted by the model. These were:

- Time series plot of the observed and predicted catch rates.
- Plot of standardised residuals against predicted values. The standardised residuals were calculated by

$$r_t = \frac{y_t - E(y_t)}{\sqrt{Var(y_t)}},$$

where $E(y_t)$ were the predicted monthly catch rates, y_t the observed monthly catch rates and $Var(y_t)$ was the variance of the stock assessment model fits

$$\hat{\sigma}^2 = \sum_t \frac{\left((\log_e(cpue_t) - \log_e(\hat{cpue}_t)) \right)^2}{n-1}.$$

- Histogram and normality plot of standardised residuals.

Parameter standard errors for the delay difference and age-structured models were taken from the square root of the diagonal elements in the asymptotic covariance matrix. The asymptotic covariance matrix of the parameter estimates was given by

$$\Sigma = -\mathbf{H}^{-1},$$

where \mathbf{H} was the matrix of second derivatives of the log-likelihood,

$$\mathbf{H} = \left[\frac{\partial^2 \log \ell}{\partial \beta_i \partial \beta_j} \right],$$

with respect to variation in model parameters evaluated at the maximum likelihood estimate. A Matlab program was developed to estimate the matrix of second derivatives (O'Neill 2002). In order to summarise the precision of the parameter estimates a series of simple t-tests were carried out. The t-tests were used to examine the significance of each parameter. The hypothesis tested was

$$H_0: \beta_i = 0 \quad H_1: \beta_i \neq 0$$

where β_i was a model estimated parameter. The t-statistic used was $t = \frac{\beta_i}{SE_{\beta_i}}$,

compared against the critical t-value for the probability level $\alpha = 0.05$ and the model residual degrees of freedom.

Confidence intervals on all outputs from the delay difference and age-structure models were generated by a Monte Carlo routine of running the models for 1000 variations in the parameters estimated. Table 8.3.6.1 outlines these steps:

Table 8.3.6.1 Algorithm used to generate 90% confidence intervals for the delay difference and age structured model outputs.

1. Use the estimated model parameters and the covariance matrix of their estimators to construct a multivariate normal distribution.
2. Draw a random sample parameter vector from the multivariate normal distribution estimated in step 1.
3. Draw a random sample of values using the assumed-known parameters.
4. Use the random sample of parameters to obtain a sample historical trajectory for the stock (i.e. run model with parameters).
5. Repeat the process from step two to four 1000 times to obtain a large number of trajectories and outputs, each of which reflects the correlations among parameter estimates.
6. Calculate 5% and 95% percentiles to generate 90% confidence intervals.

In addition, to demonstrate the delay difference and age structured models sensitivity to the assumed known biological parameters, we compared outputs by changing one parameter value at a time to other plausible values, typically to their upper or lower confidence interval.

Bootstrap methods were used for the surplus production models to obtain distributions of parameter estimates and bias corrected confidence intervals on all outputs (Haddon 2001). The methods used a series of steps to resample the residuals $\left(\frac{cpue}{\hat{cpue}}\right)^*$ from the optimal model fits. A total of 5000 independent catch rate time-series were generated by the bootstrap sampling. Each independent catch-rate series were constructed by

$$cpue^* = \hat{cpue} \left(\frac{cpue}{\hat{cpue}} \right)^*$$

where $cpue^*$ were the new bootstrapped catch rates, \hat{cpue} were the optimised models predicted catch rates, and $cpue$ were the observed standardised catch rates. The surplus production models were fitted to all 5000 catch-rate time series. Bias corrected 90% confidence intervals were calculated on all model outputs by adjusting the appropriate lower and upper percentiles by

$$P_{lower} = \Phi(2z - 1.645)$$

$$P_{upper} = \Phi(2z + 1.645)$$

where z is the inverse cumulative normal distribution of the proportion of bootstraps less than the optimal estimate $z = \Phi^{-1}(p_{lessthan})$.

8.3.7 Historical Trawl Data

Logbook catch data prior to the implementation of the compulsory QFISH logbook system in 1988 are of varying quantity and quality. To extract this data in a

compatible form for comparison with current data obtained from the QFISH system, considerable cleaning and transformation were required.

Data sources

Historical trawl data consists of all the scallop and prawn records obtained from approximately 16 sources (Table 8.3.7.1). This data resides in the HTRAWL database within the QFISH system. Of these records only a subset were finally used in the statistical analysis. These data are outlined in the results.

Table 8.3.7.1 Historical trawl data sources and description.

Source	Description	# Records	Source	Description	# Records
AFS	AFMA logs	85 600	DI02	Diary data entry (DE)	36 200
BH	Burnett Heads Research Station voluntary logbook program	25 800	DI03	Historic DE- CSIRO grids	31 700
BH85	As above	3400	DPI	DPI research log	14 600
CF88	CFISH pre-1988	9900	ECP	CSIRO research log	20 400
CS1B	CSIRO (B)ay	26 400	NSW	NSW voluntary logs	11 700
CS1N	CSIRO (N)orth, King and tiger prawn	30 500	UL01	Historic DE–CSIRO grids	340
CS1O	CSIRO (O)cean, King prawn	17 500	UL02	Historic DE–SUNFISH grids	2100
DI01	Diary data entry (DE)	32 400	UL03	Uncollected logs –CSIRO grids	80

Source: *z DataSourcesQry* in *w-research\FRDC1999120\cfish&cls\AllTrawl.mdb* and *G. Duckworth*, personal communication, Jan 2001.

Data transformation

Initial inspection of the data revealed several anomalies regarding recording methods of fishermen, logbook design and implementation, data entry protocols and database management. Methods for converting the data into a form suitable for comparison with QFISH data are presented in the following sections.

No logbook programs overlapped in time, although there were periods when a collection program ceased and then a similar program started (e.g. BH (1997–1984), BH85 (1985), BH (1986–1987)). BH85 data was BH data collected in 1985. Note that there were also 1985 data sourced from BH (Table 8.3.7.1).

QFISH grid conversion

Location details in HTRAWL usually consisted of grid numbers reported in the ‘start grid’ field. The spatial resolution of the grid numbers reported in BH, BH85, UL01 and DPI data sources covered a larger area than present QFISH grids (60' × 60' minute). For example, historical grid number 235 includes QFISH grids U28 (EKP Deep only), U29 (EKP Deep only) and U30 (which is SCALLOP and EKP Deep). To convert catches in these grids to QFISH grids the following guide was used.

Catches from historic location grids were compared with catches within QFISH that overlapped historic grids. Comparisons were made in similar time intervals. The QFISH grid that contained the majority of records was substituted as the locator for the historic record. For example, the grid 225 contains QFISH grids S23 to S26 and T23 to T26. A pivot table was run with start grid as a row variable and species as a column variable. For grid 225 it was found that the majority of the scallop catch was in QFISH grid S26.

Grid numbers for the ECP data source were defined using a CSIRO grid system, which is based on a four digit number covering a 6×6 minute grid. The first two digits represent six minutes of longitude starting with 00 at 150°E for the Queensland fishery, and the last two representing six minutes of latitude starting with 00 at 10°S . With this grid number system the grid numbers for latitude repeated at 20°S . An MS Access query was written which matched the first two digits to a QFISH grid letter, and the last two digits to a QFISH grid number. Also included in the query was a decision rule to distinguish between 'northern' and 'southern' CSIRO grid numbers representing latitude.

Where no information regarding grids was available, reported latitudes and longitudes were matched to QFISH grids. Records with no location details were excluded from the analysis

Fishing time

Fishing duration reported from DPI&F and CSIRO data sources was converted from minutes to hours. If fishing duration was not reported the difference between start and end time was used. Records with fishing time absent were excluded.

Scallops

The CF88 scallop data source contained an unusual error, where the value for the end of a log week was replaced with the sum total for the week. This data was cleaned manually by referring to every original log sheet in the archive.

All BH and DPI scallop data were reported in the database as kilograms. To convert kilograms to baskets a conversion table was developed. The basket to kilogram ratio changed within and between years. By manually going through original logbooks that reported catches in baskets, the conversion factor used by previous data entry operators was calculated and applied to the data. Some errors were subsequently introduced due to the following:

1. Some of the trip data has actual total kilo catch, and this is used to convert baskets to kilos for each shot/day instead of applying the normal conversion factor.
2. Some conversion factors are applied to the wrong months and even change within month for the same boat in the database.
3. Where conversion factors are missing (i.e. no scallop data found for month/year combination) the factors for the closest years were applied.

Scallop catch was converted from shot by shot to daily catches. To ensure consistency in reporting catch rates, if the running total of hours trawled exceeded 14 for any one-day, the total daily catch per boat day (i.e. 14 hours) was multiplied by 14 and divided by the total hours trawled.

Prawns

The following criteria were used to create the final historic prawn tables

1. The fishery is primarily a night-time fishery, therefore the same conversion of catch rates applied to scallops was also applied to prawns.
2. Any records where the fishing start time began between 0700 and 1600 were removed from the final table. This is to ensure that we are reporting night-time catches only. The extra leeway in start and end time is given as many trawls began slightly before dusk and ended slightly after dawn. It should also be noted that the average daylight duration in winter is shorter than during summer.
3. Daily catch data was based on the sum total of catch for any given boat day. The cumulative time trawled for one boat day is also included. Note that daily catch is independent of hours trawled for that day.

8.3.8 Spawner-recruitment Relationships

One of the most important pieces of information required for modelling the status of fisheries is the relationship between spawning and recruitment. This relationship defines how much the spawning stock can be reduced before recruitment is not sufficient enough to replace those being caught. This is known as recruitment overfishing. Annual recruitment is naturally highly variable and very difficult to quantify. To conduct a management strategy evaluation, a spawner-recruitment relationship is generally required to project the population and fishery forward in time to examine different management scenarios. The main purpose of using spawner-recruitment relationships here was not to determine the status of the prawns and scallop stocks, but to test reference points. Detailed discussions are still required with management and industry to clearly define and accept these relationships. The stock assessment and simulation results all considered different forms of spawner recruitment relationships.

Spawner-recruitment relationships for eastern king prawns and saucer scallops were constructed from daily catch rate records contained in the historical trawl (1969 to 1987) and QFISH (1988 to 2001) databases. The data from both databases were combined and structured accordingly for analysis:

1. Catch rate – catch per boat per night. Catches were measured in kilograms for eastern king prawns and numbers of baskets for scallops.
2. Fishing Year – 1969 to 2001.

3. Fishing location – 30-minute latitude areas.
4. Recruitment and spawning indices – catch rates from November through to February were assumed to represent recruitment, spawning related to catch rates from May to August, and catch rates from March, April and September were treated as non-spawning-recruitment months. These periods applied to both eastern king prawn and saucer scallop stocks. No spatial definitions for recruitment or spawning were applied.

To develop the spawner-recruitment relationships the following were undertaken:

1. A general linear model was used to estimate spawner-recruitment parameters and their standard errors. The exponential function on the parameter estimates represented the proportional change in average catch rates for the recruitment and spawning periods from 1970 to 2001, standardised for the different fishing locations and fishing power. Interaction effects between fishing years and spawner-recruitment periods were used to represent the indices. Only additive effects were allowed for in the fishing location term. A natural logarithm transformation was used to linearise the analysis and to normalise the residuals.
2. The resulting parameter estimates were adjusted for average changes in fishing power. Parameter estimates from 1989 to 1999 were adjusted using the statistical estimated changes in fishing power (Chapter 6). The yearly average increase in fishing power from 1989 to 1999 was used to predict fishing power in 2000 and 2001, and projected back for the years 1970 to 1988. Once the parameter estimates were adjusted for fishing power changes, they were assumed to represent spawner-recruitment indices from 1970 to 2001. Alternate assumptions on annual increases in fishing power were also examined; no annual increases and increases according to the lower confidence interval were tested for eastern king prawns; no increases and increases according to the upper confidence interval were tested for saucer scallops.
3. The adjusted parameter estimates were scaled to the estimated recruitments and spawner numbers from the delay difference and age-structured stock assessment models. This was in order to give absolute population estimates of recruitment and spawners.
4. The Beverton and Holt and Ricker forms of stock recruitment relationships were applied to the data (Table 8.3.8.1) (Haddon 2001). Given the paucity of data in some of the historical database years, a weighted log-likelihood was used for fitting the two stock recruitment relationships:

$$-\log \ell = \frac{n}{2} \left(\log(2\pi) + 2 \log \left(\text{sqrt} \left(\frac{1}{n} \sum_y (\log(\hat{R}_y) - \log(\hat{R}_y))^2 * w_y \right) \right) + 1 \right)$$

where n was number of fishing years, y identified a fishing year, π is 3.14159, \log is the natural logarithm function, sqrt is the square root function, R_y was the rescaled measured number of recruits, \hat{R}_y was the predicted number of recruits and w_y was the

weighting factor based on the proportion of all data in year t (Table 8.4.1.5 and Table 8.4.3.3).

Unlike eastern king prawns and saucer scallops, the spawner-recruitment relationships were fitted directly to the estimated spawning and recruitment levels from the Torres Strait tiger prawn delay difference model. This was possible because the entire time series of total catches and catch rates stretched 23 years and therefore an unweighted log-likelihood was used (i.e. $w_t = 1$).

Table 8.3.8.1 Spawner-recruitment (S/R) and steepness equations.

	Equation	Notation
Beverton-Holt S/R	$\hat{R}_y = \frac{S_y}{\alpha + \beta S_y} e^\eta$	y : fishing years S_y : Female Spawning Index α, β : spawner-recruitment parameters to be estimated
Ricker S/R	$\hat{R}_y = \alpha S_y e^{-\beta S_y} e^\eta$	e^η : log normal error
Steepness of S/R	$\frac{\hat{R}_{0.2S_0}}{\hat{R}_0}$	$\hat{R}_{0.2S_0}$: mean recruitment at 20% virgin spawning stock. \hat{R}_0 : virgin recruitment.

The ‘fminsearch’ simplex search routine was used to carry out parameter estimation (MATLAB 2002). The parameter covariance matrix was given by the inverse of the matrix of second derivatives of the weighted log-likelihood.

In addition to fitting the stock-recruitment relationships, the resulting residuals were examined for autocorrelations and patterns to determine if the model fit was inadequate. If significant autocorrelation is present, recruitment successes may be correlated. That is, high recruitment years may be followed by another high year, and low recruitment years followed by another low year. The cause of autocorrelations may be due to environmental effects on the stock recruitment relationship. Autocorrelations were examined using the autoregressive integrated moving-average (ARIMA) time-series modelling package in Genstat 6 (Genstat 2002). This measured the amount of correlation between residuals for different time lags ranging from one to twenty years. The results showed no significant autocorrelations to suggest obvious environmental effects or any necessity to consider alternative likelihood fitting procedures (Dichmont et al. 2001). Scatter plots of residuals against predicted recruitments were used to show that no patterns existed and that the model fits were adequate.

8.3.9 Equilibrium Reference Points

The Delay-difference and age-structured models

The calculations of management reference points were based on optimising the dynamics of the models through fishing effort for a *per-recruit* analysis using the

parameters q , μ_r , θ_r , σ_r , M , α and β . One prawn or scallop recruit was fed into the model. The recruit was fished over twenty years to ensure that the yield was maximised at different levels of fishing effort. The products from the 20 years of fishing were the spawning-per-recruit and yield-per-recruit values as a function of fishing effort. Equilibrium catch measured in kilograms or numbers was given by:

$$C(E) = R(E)\tilde{C}(E),$$

where $R(E)$ was the spawner-recruitment function of fishing effort, and $\tilde{C}(E)$ was the yield-per-recruit function of fishing effort. Similarly the equilibrium spawning index was $S(E) = R(E)SB(E)$ where $SB(E)$ was the spawner per recruit. Solving the equation in Table 8.3.8.1 for $R(E)$ then gives:

$$R(E) = \frac{\log_e(\alpha SB(E))}{\beta SB(E)},$$

for the Ricker spawner-recruitment curve and by

$$R(E) = \frac{SB(E) - \alpha}{\beta SB(E)},$$

for the Beverton-Holt spawner-recruitment relationship.

$SB(E)$ was the spawning-per-recruit function, and α and β were the spawner-recruitment parameters. The $\tilde{C}(E)$ and $SB(E)$ functions use the catch and spawning equations respectively in Table 8.3.3.1 for the delay difference model and section 8.3.4 for the age structured model. The dynamics of the models were optimised for various reference points including catch and standardised fishing-effort at Maximum Sustainable Yield (MSY and E_{MSY} ; Figure 8.3.9.1).

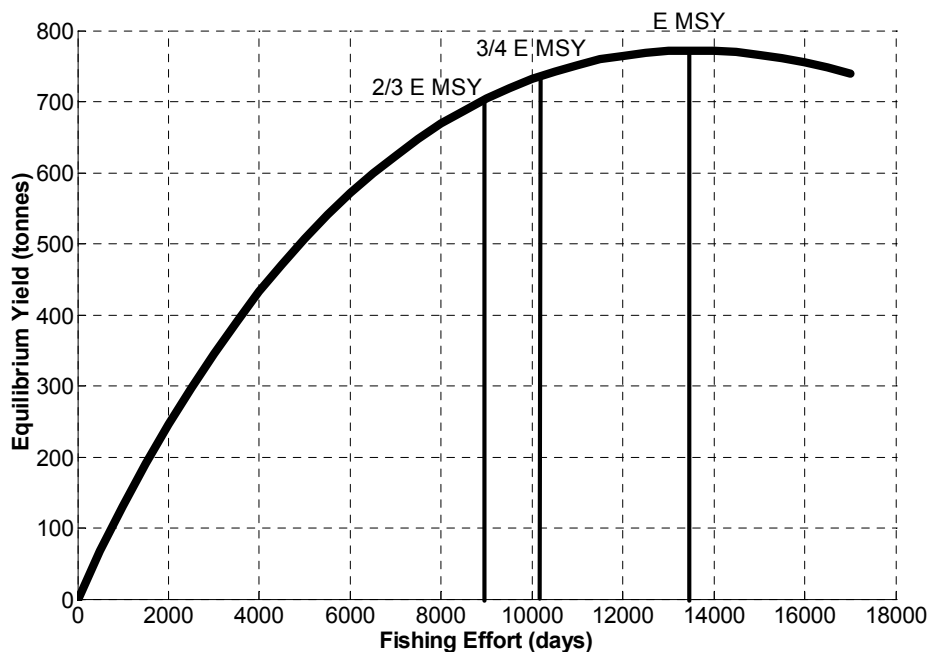

Figure 8.3.9.1 Illustrative (hypothetical) example shows how the various reference points may relate. Maximum sustainable yield is the largest reference shown by the right-hand dotted line, the next smallest is 3/4 of MSY Effort, then 2/3 of MSY Effort. In this example, $F_{0.1}$ is similar to 2/3 of MSY Effort.

The surplus production model

The calculations of equilibrium reference points differ for the Schaefer and Fox models (Haddon 2001; Hilborn and Walters 1992). Maximum sustainable yield and the fishing effort required to catch MSY, E_{MSY} , were calculated by

$$MSY = \frac{rK}{4} \text{ and } E_{MSY} = \frac{r}{2q} \text{ for the Schaefer model, and}$$

$$MSY = \frac{rK}{e^1} \text{ and } E_{MSY} = \frac{r}{q} \text{ for the fox model.}$$

The parameters r , K , and q are defined for the surplus production model in section 8.3.5, page 91.

8.3.10 Reference Point Simulations

On completion of the base assessments, the performances of different reference points were tested through a series of simulations (Table 8.3.10.1). The simulations for each trawl sector included decision analysis procedures, to demonstrate the performance of a range of possible management systems and reference points. The approach of testing reference points was streamlined to allow management responses to be modelled ahead of time, so that the results can be used to help develop alternative and improved management systems. The algorithm we used for the simulations was similar to the forward projection methodology used by (Richards et al. 1998) and the management strategy evaluation approach by (Punt et al. 2001b). The simulation steps are outlined in Table 8.3.10.2 and Figure 8.3.10.3. Details of the uncertainties allowed for are shown in Table 8.3.10.3 and Table 8.3.10.4. The expected median outcomes and probabilities indicating risks of overfishing are presented in the results section.

To evaluate potential reference points the monthly delay difference (for prawns) or age-structured (for scallops) models were used to operate the possible or hypothetical dynamics of the populations. This component of the simulations can be labelled as the ‘operating model’ (Figure 8.3.10.1). It captures the temporal dynamics of the stocks and allows for stochastic variations (uncertainty) in all parameters. The other component of the simulations is the ‘assessment model’ (Figure 8.3.10.1). This represents our real life process to assess the state of the stocks (i.e. using CPUE reference points every year or stock assessment models every two years). The structures of both the operating and assessment models were similar, but differ in that the operating model functions on random variations in all parameters (e.g. spawner-recruitment, natural mortality etc). The assessment-model parameters, updated every one or two years, represent our estimate of the average dynamics of the population, and so it includes error in our judgement to apply appropriate fishing strategies.

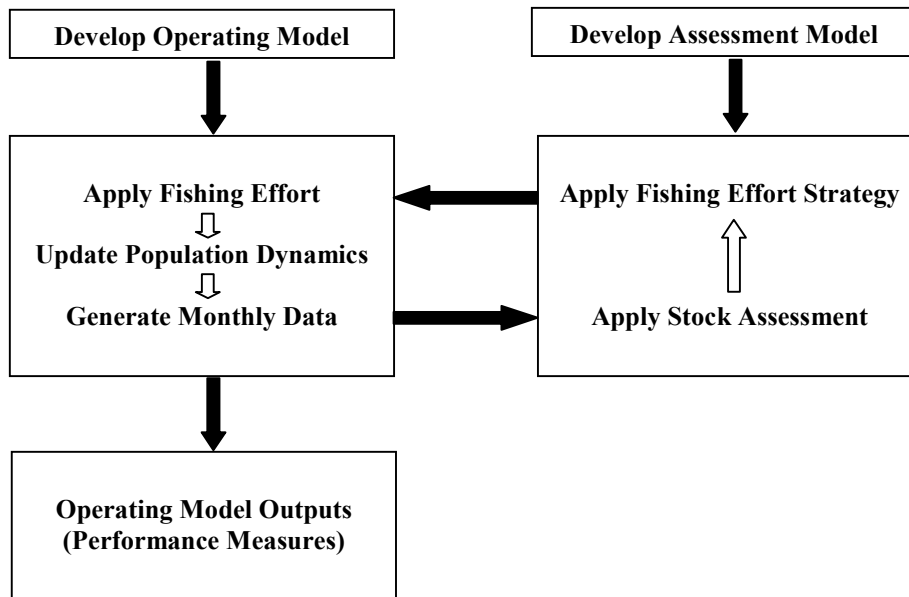

Figure 8.3.10.1 Flow diagram illustrating the simulation approach. The operating model represents the population dynamics where fishing is applied and the dynamics are calculated (i.e. monthly population sizes, catches, catch rates etc). The assessment model represents us conducting stock assessments using models every two years or catch-rates every year and then applying a fishing effort strategy based on the results. The process was circular for twenty years and the outputs for each year were recorded for a number of performance measures (e.g. risks of over fishing, expected catches etc; defined page 106).

Table 8.3.10.1 The catch rate and fishing mortality reference points examined through simulation. Their link to fisheries management is defined under the management strategy evaluation (MSE) below. $cpue_t$ were the average catch rates in the current review periods described in the Queensland east coast trawl management plan (QECTMP); $60\%cpue$, $70\%cpue$, and $80\%cpue$ were the percentage of the average catch rates from the reference review periods between 1988 and 1997 (QECTMP 2001).

Target Species	Limit Reference Points	Upper Reference Points	Limit Review (Months)	Upper Review (Months)	Simulation Framework
Eastern King Prawns	$cpue_t < 60\%cpue$	$cpue_t > 97.5$ percentile	Nov to Feb or ¹	Nov to Feb and ²	Delay Difference Model
	$cpue_t < 70\%cpue$	None	May to Aug	May to Aug	
	$cpue_t < 80\%cpue$				
Torres Strait Tiger Prawns	$cpue_t < 60\%cpue$	$cpue_t > 97.5$ percentile	Mar to Jun	Mar to Jun	Delay Difference Model
	$cpue_t < 70\%cpue$	None			
	$cpue_t < 80\%cpue$				
Saucer Scallop	$cpue_t < 60\%cpue$	$cpue_t > 97.5$ percentile	Nov to Feb	Nov to Feb	Age Structured Model
	$cpue_t < 70\%cpue$	None			
	$cpue_t < 80\%cpue$				
Eastern King Prawns	$cpue_t < 60\%cpue$	$cpue_t > 97.5$ percentile None	Annual	Annual	Surplus Production Model
Tiger Prawns	$cpue_t < 70\%cpue$				
Saucer Scallop	$cpue_t < 80\%cpue$				
Eastern King Prawns	F_{MSY} $3/4 F_{MSY}$ $2/3 F_{MSY}$	N/A	N/A	N/A	Delay Difference and Age Structured Models
Tiger Prawns					
Saucer Scallop					

or¹ indicates that a low average eastern king prawn catch-rate in either limit review period can trigger management; **and**² indicates that a high average eastern king prawn catch-rate in both upper review periods is required to trigger management. The other sectors have single review periods.

Table 8.3.10.2 Algorithm to simulate reference points.

1. Optimise the base stock assessment model to the observed catch rate data for the stock.
2. For the delay difference and age-structured models, use the estimated model parameters and their covariance matrix to construct a multivariate normal distribution. For the surplus production model use bootstrap replicates of the parameter estimates.
3. Draw a random sample parameter vector from the multivariate normal or bootstrap distributions estimated in step 2.
4. Draw a random sample of values from the assumed known biological parameters (ignore for surplus production model).
5. Use the random sample of parameters to drive the operating model and to obtain a sample historical trajectory for the stock.
6. Choose a reference point to test (e.g. 70% average catch rate) and starting level of fishing effort.
7. Run the operating model forward 20 years. Recruitment is simulated either under a spawner-recruitment relationship or assumed to be random for the delay difference and surplus production models. At the end of each management period decisions were made based on the assessment model. Management periods were one year for catch-rate and two years for fishing mortality (F) (assessment model) reference points. If the reference points were triggered, a decision was made to alter next year's level of fishing effort according to the management strategy.
8. The process from steps 3 to 7 were repeated for a large number of times, to obtain a large number of trajectories, each of which reflected the correlations among model parameters estimated (delay difference and age structured models – 1000 times for catch-rate and 500 times for F based reference points; surplus production models 5000 times for catch rate reference points).

The results of using different reference points were summarised in a management strategy evaluation (MSE) framework (Punt et al. 2001b; Smith 1994). Management strategy evaluation involved assessing the consequences of a range of management strategies and presented the results in a way which lays bare the trade-offs in performance across a range of management objectives (Smith 1994). The approach does not define a final fishing strategy or decision, but rather provides information on which to base management choices, given a set of management objectives. To fully understand the structure of the MSE results here in, the following key elements and definitions were used:

- The *fishing strategies* were the number of vessel days allowed in the fishery each fishing year. A number of initial fishing strategies were examined. For example, the eastern king prawn starting test fishing effort ranged from 45 000 to 15 000 days, at 5000-day intervals.

- The **management strategies** were the decisions on how fishing effort was changed in response to a triggered limit reference point. The management strategies tested were:
 1. Status quo or ‘control’: no reference points or management interventions.
 2. Moderate two-way: if the lower catch-rate limit reference point was triggered, fishing effort was reduced by 10%; if the upper catch rate limit reference point was exceeded, fishing effort was allowed to increase by 5%.
 3. Heavy two-way: if the lower catch-rate limit reference point was triggered, fishing effort was reduced by 30%; if the upper catch-rate limit reference point was exceeded, fishing effort was allowed to increase by 15%.
 4. Moderate one-way: if the lower catch-rate limit reference point was triggered, fishing effort was reduced by 10%; no increases in fishing effort allowed.
 5. Heavy one-way: if the lower catch-rate limit reference point was triggered, fishing effort was reduced by 30%; no increases in fishing effort allowed.
 6. Fishing mortality (F) based: fishing effort was altered every two years according to the reference point estimates of Maximum Sustainable Yield (MSY), $\frac{3}{4}$ MSY and $\frac{2}{3}$ MSY. They were derived from stock assessments undertaken every two years. These three MSY control rules manage fishing effort at population sizes above half the biomass that supports MSY ($0.5B_{MSY}$) (Figure 8.3.10.2). If the population sizes fall below half of B_{MSY} , the levels of fishing effort were reduced as a function of biomass:

$$\begin{cases} F(B) = \frac{F_{refpt} B_t}{cB_{MSY}} & \text{for } B_t < 0.5B_{MSY} \\ F(B) = F_{refpt} & \text{for } B_t \geq 0.5B_{MSY} \end{cases} \quad (\text{Restrepo et al. 1998}),$$

where F_{refpt} was F_{MSY} , $F_{3/4MSY}$, or $F_{2/3MSY}$.

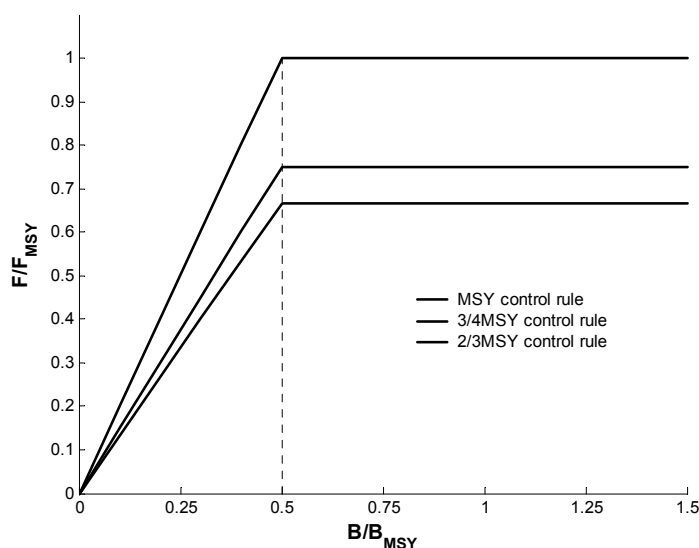

Figure 8.3.10.2 Illustrating the fishing mortality reference point control rules.

- The *management objectives* were 1) biological sustainability of the stocks, 2) viability for industry, and 3) minimise activity and maximise accuracy of management.
- A number of different performance measures were used to gauge each fishing strategy and management strategy against the management objectives.
Two quantitative measures of biological sustainability were used:

1. The risks (probabilities) over a 20-year period of management that the stock size will fall below 20% of the equilibrium virgin (unfished) population biomass. The 20% value is not meant to represent the threshold of recruitment overfishing, but rather to indicate that the stock has been substantially fished down.
2. The risks (probabilities) over a 20-year period of management that the stock size will fall below the long-term equilibrium population biomass that results from fishing the stock at maximum sustainable yield (B_{MSY}).

Three quantitative measures of industry sustainability were used:

1. The median total catch over the 20-year period of management.
2. The median variation in total catch over the 20-year period of management (average coefficient of variation).
3. The median of the resulting total fishing effort over the 20-year period of management.

Three quantitative measures for management performance were used:

1. The average number of CPUE reference point triggers over the 20-year period of management.
2. The distribution of population sizes when CPUE reference points trigger, expressed as a ratio of virgin biomasses.
3. Proportion of triggers accurately detecting population sizes below 20% of virgin biomass or the biomass that supports MSY (B_{MSY}).

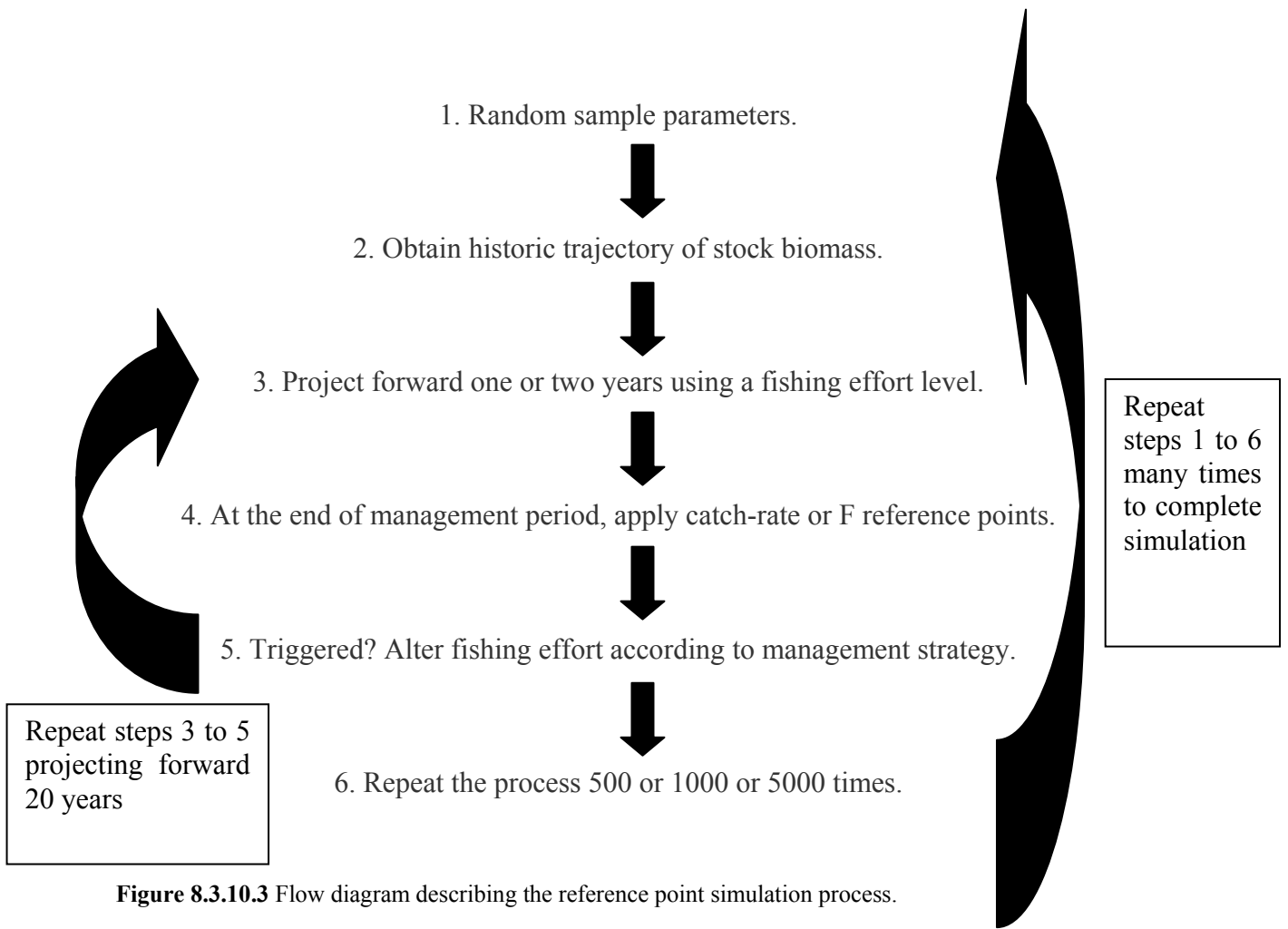

Figure 8.3.10.3 Flow diagram describing the reference point simulation process.

Table 8.3.10.3 Details of the uncertainties allowed for in the eastern king and tiger prawn delay difference operating models. The italic syntax represents Matlab functions. Graphical display of the error distributions and their justifications are presented in the results section.

Parameters	Sampling and Error Distributions
Prawn catchability – q Prawn recruitment pattern – μ_r , θ_r and σ_r Number of prawn recruits R_y	$\left\{ \begin{array}{l} mvnrnd(mle, cov, 1000) \end{array} \right.$ <p>The <i>mvnrnd</i> function returned a 1000 by number-of-parameters matrix of random values chosen from the multivariate normal distribution with maximum likelihood estimates <i>mle</i>, and covariance matrix <i>cov</i>.</p>
Prawn growth ρ	$normrnd(\rho, 0.1, 1000, 1)$ <p>The <i>normrnd</i> function generated 1000 normal random prawn growth values with mean ρ and standard deviation 0.1.</p>
Monthly natural mortality M	$normrnd(0.2, 0.05, 1000, m)$ <p>The <i>normrnd</i> function generated 1000 by number-of-months (m) matrix of normal random natural mortality values with mean 0.2 and standard deviation 0.05.</p>
Spawning pattern β	$normrnd(\beta, 0.2 * \beta)$ <p>The <i>normrnd</i> function generated normal random monthly variations of the spawning pattern with mean β and standard deviation 0.2β. In addition, these means were randomised to produce varying spawning peaks within the typical high and low reproductive periods. The resulting random spawning pattern β was normalised to 1; 1000 variations were produced.</p>
Fishing Power Increases $qinc$ up to 1999	$normrnd(qinc, sd_qinc)$ <p>The <i>normrnd</i> function generated normal random fishing power increases with mean $qinc$ and standard deviation sd_qinc; 1000 variations were produced.</p>
Fishing Power Increases $qinc$ 2000 and beyond	$\exp(\log(qinc) + normrnd(0, sd_fit))$ <p>The function generated log normal random errors on the predicted future proportional fishing power changes (based on pre 2000 random variations), where sd_fit was the standard deviation of the linear fit to variations in $\log(qinc_{upto\ 1999})$.</p>
Spawning – recruitment relationship (S/R) α β	$\left\{ \begin{array}{l} mvnrnd([\alpha\ \beta], cov, 1000) \end{array} \right.$ <p>The <i>mvnrnd</i> function returned a 1000-by-2 matrix of random S/R values chosen from the multivariate normal distribution with maximum likelihood estimates $[\alpha\ \beta]$, and covariance <i>cov</i>.</p>
Predicted recruitment errors $\varepsilon_{S/R}$	$\exp(normrnd(0, \log_std, yrs, 1))$ <p>The exponential function returned log-normal errors with a log-mean of zero and log standard deviation from the S/R fits for every fishing-year (<i>yrs</i>) recruitment; 1000 variations were produced.</p>

Parameters	Sampling and Error Distributions
Random recruitments (no S/R) Only for eastern king prawns	$unifrnd(\text{min_rec}, \text{max_rec}, 1000, \text{yrs})$ The $unifrnd$ function generated 1000 continuous uniform random values between the maximum-likelihood-estimated minimum and maximum recruitments, where yrs is the number of fishing years of random recruitment.
Model error on predicted catch rates	$\exp(\text{normrnd}(0, \text{log_std}, t, 1))$ The exponential function returned log-normal errors with a log-mean of zero and log standard deviation from the stock assessment model fits, for every monthly time period t ; 1000 variations were produced.
Monthly Fishing Effort Pattern	$\text{normrnd}(\text{effort_pattern}, \text{sd_effort_pattern})$ The normrnd function generated normal random fishing effort patterns with monthly mean effort_pattern and standard deviation sd_effort_pattern ; 1000 variations were produced.

Table 8.3.10.4 Details of the uncertainties allowed for in the saucer scallop age-structured operating model. The italic syntax represents Matlab functions. Graphical display of the error distributions and their justifications are presented in the results section.

Parameters	Sampling and Error Distributions
Scallop catchability – q Scallop recruitment pattern – μ_r , θ_r and σ_r Number of prawn recruits R_y and R_{av}	$\left\{ \text{mvnrnd}(mle, cov, 1000) \right.$ The mvnrnd function returned a 1000 by number-of-parameters matrix of random values chosen from the multivariate normal distribution with maximum likelihood estimates mle , and covariance matrix cov .
Monthly natural mortality M	$\text{normrnd}(0.09, 0.01, 1000, m)$ The normrnd function generated 1000 by number-of-months (m) matrix of normal random natural mortality values with mean 0.09 and standard deviation 0.01.
Spawning pattern β	$\text{normrnd}(\beta, 0.2 * \beta)$ The normrnd function generated normal random monthly variations of the spawning pattern with mean β and standard deviation 0.2β . In addition, these means were randomised to produce varying spawning peaks within the typical high and low reproductive periods. The resulting random spawning pattern β was normalised to 1; 1000 variations were produced.
Fishing Power Increases $qinc$ up to 1999	$\text{normrnd}(qinc, sd_qinc)$ The normrnd function generated normal random fishing power increases with mean $qinc$ and standard deviation sd_qinc ; 1000 variations were produced.
Fishing Power Increases $qinc$ 2000 and beyond	$\exp(\log(qinc) + \text{normrnd}(0, sd_fit))$ The function generated log normal random errors on the predicted future proportional fishing power changes (based on pre-2000 random variations), where sd_fit was the standard deviation of the linear fit to variations in $\log(qinc_{upto\ 1999})$.

Parameters	Sampling and Error Distributions
Spawning – recruitment relationship (S/R)	$mvrnd([\alpha\beta], cov, 1000)$
α β	The <i>mvrnd</i> function returned a 1000-by-2 matrix of random S/R values chosen from the multivariate normal distribution with maximum likelihood estimates $[\alpha \beta]$, and covariance cov.
Predicted recruitment errors $\varepsilon_{S/R}$	$exp(normrnd(0, log_std, yrs, 1))$ The exponential function returned log-normal errors with a log-mean of zero and log standard deviation from the S/R fits for every fishing-year (yrs) recruitment; 1000 variations were produced.
Model error on predicted catch rates	$exp(normrnd(0, log_std, t, 1))$ The exponential function returned log-normal errors with a log-mean of zero and log standard deviation from the stock assessment model fit, for every monthly time period t ; 1000 variations were produced.
Monthly Fishing Effort Pattern	$normrnd(effort_pattern, sd_effort_pattern)$ The <i>normrnd</i> function generated normal random fishing effort patterns with monthly mean <i>effort_pattern</i> and standard deviation <i>sd_effort_pattern</i> ; 1000 variations were produced.
Mean length at age	$normrnd(L_{\infty}, std, 1000, 1)$ $normrnd(k, std, 1000, 1)$ The <i>normrnd</i> functions generated 1000 normal random variations in the growth curve parameters L_{∞} , and k . This variation was incorporated into calculating mean scallop weight at age and selectivity schedules at 90mm and 95mm.
Maturity at age	$mvrnd(binomial_params, cov, 1000)$ The <i>mvrnd</i> function returned a 1000-by-2 matrix of random binomial parameters chosen from the multivariate normal distribution with least squares estimates, and covariance cov. The binomial parameters calculate the proportion mature at age; used in spawning stock function.
Fecundity at size	$normrnd(fecundity_age, std)$ The <i>normrnd</i> function generated normal random fecundity estimates at age; 1000 variations were produced. Variations in mean length at age were incorporated.
Replenishment areas (closures)	$unifrnd(0.7*min_closure_est, 1.3*max_closure_est, 1000, yrs)$ The Long-term Monitoring Program estimates of scallop numbers within the closures were used to adjust the exploitable biomass estimates. The <i>unifrnd</i> function generated 1000 continuous uniform random values between 70% of the minimum and 130% of the maximum mean scallop numbers from the October 2000 and 2001 surveys, where yrs was the number of fishing years where the closures were in place.

8.4 RESULTS

8.4.1 Eastern King Prawns

Catch Statistics

The offshore eastern king prawn harvest, excluding Moreton Bay, consistently averaged 1719 t in Queensland and 848 t in New South Wales between the 1989 and 2000 fishing years (Figure 8.4.1.1). Total catches in 2001 increased notably to 2404 t and 1063 t from Queensland and New South Wales waters respectively. Fishing efforts applied to eastern king prawns between 1989 and 2001 were consistent, averaging 20 739 nights in Queensland and 20 439 nights in New South Wales. Average monthly standardised-catch-rates in Queensland and New South Wales were stable between 1989 and 2000, but increased in 2001 (Figure 8.4.1.2). In Queensland waters monthly standardised-catch-rates peaked at an average of 124 kgs for the 2001 fishing-year between February 2001 and April 2001. Standardised catch rates for the same months in New South Wales were 58 kgs.

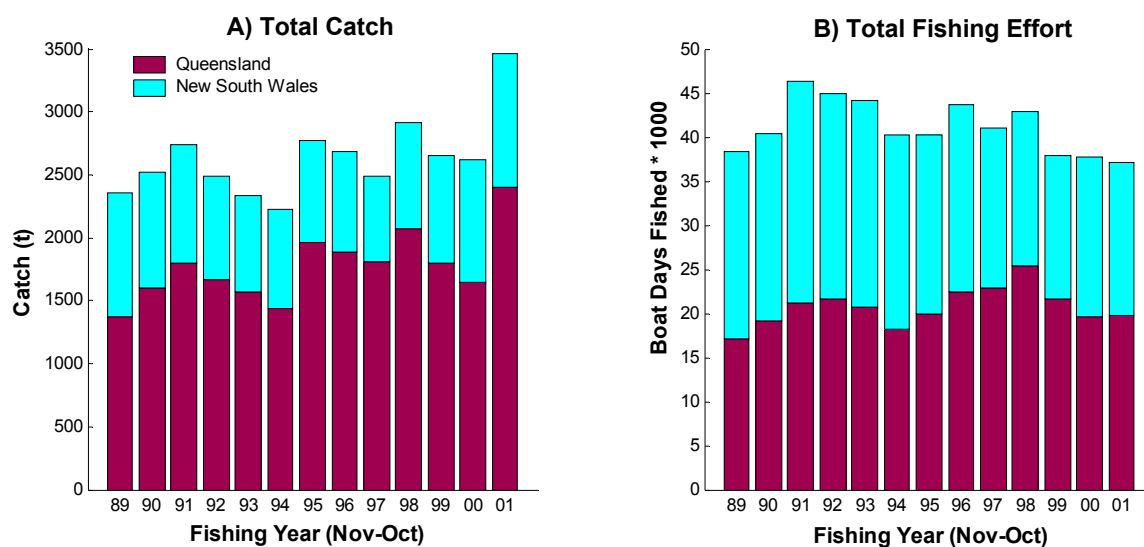

Figure 8.4.1.1 Queensland and New South Wales eastern king prawn catches and fishing effort from 1989 to 2001; note the large total catch taken in 2001.

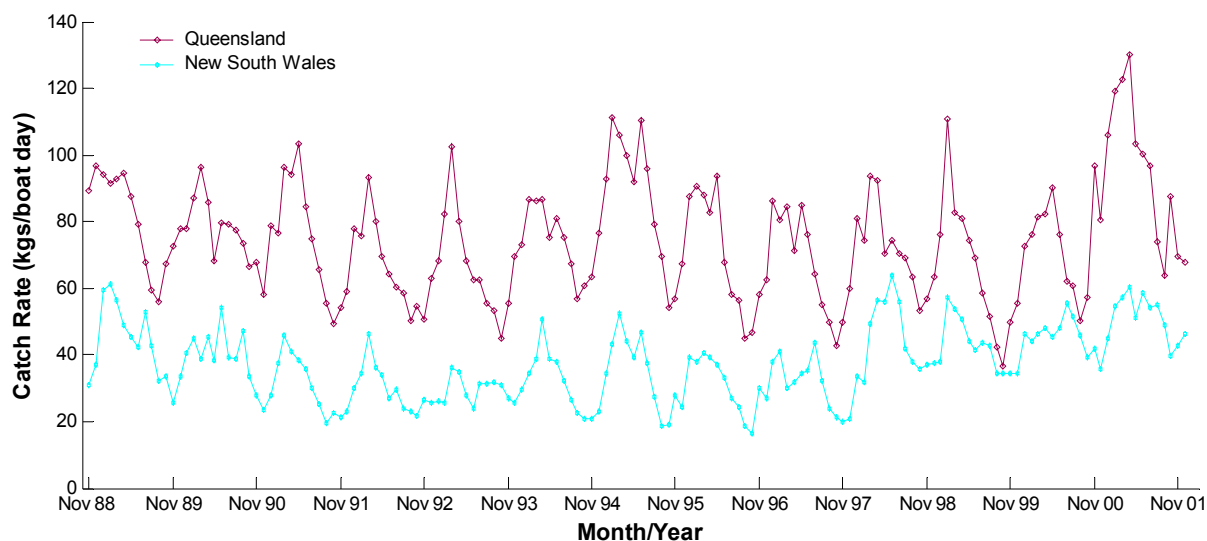

Figure 8.4.1.2 Queensland and New South Wales monthly standardised catch rates from November 1988 to December 2001; note the similar cycles between states and the high catch rates reported in Queensland for 2001.

Biological Inputs

In most stock assessment models independent estimates of biological parameters are incorporated to calculate the dynamics of populations. Table 8.3.3.1 contains a summary of the biological inputs used to calculate average prawn growth, weight, size at first recruitment to the fishery and one month prior, natural mortality and the relative monthly spawning pattern. These biological parameters are deterministic and the model sensitivity to these is reported as part of the stock assessment. The parameters are treated as the base case against which the model sensitivities are measured. The measure of relative spawning was based on the incidence of female prawns that were histologically classed as mature or ripe (Courtney 1997). Generally, the relative amount of spawning was greatest between May and October (Figure 8.4.1.3). This result was used with the population estimates in the model to calculate spawning stock sizes.

Table 8.4.1.1 Eastern king prawn biological parameters used as fixed inputs into the monthly delay difference model.

<i>Parameters</i>	<i>Estimates</i>	<i>Data Sources</i>
<i>Von Bertalanffy Prawn Growth</i>		
$L_{\infty} k$ (male)	41 CL mm; 0.34 month ⁻¹	(Die et al. 1999), and
$L_{\infty} k$ (female)	53 CL mm; 0.25 month ⁻¹	(Glaister et al. 1987)
<i>Brody Prawn Growth</i>		
ρ (sexes combined)	0.942276764	As above
<i>Carapace Length to Weight</i>		
$w_{grams} = aCL^b$		
a_{male}, b_{male}	0.00102, 2.839	1988-91 data from (Courtney 1997)
a_{female}, b_{female}	0.001677, 2.7005	
<i>Carapace Length at Recruitment</i>		
Male	26 mm	(Die et al. 1999), and
Female	31 mm	(Glaister et al. 1987)
<i>Instantaneous rate of natural mortality (M)</i>	0.2 month ⁻¹	(Lucas 1974) and (Garcia 1985)
<i>Monthly Spawning Pattern (Proportion, β)</i>		
November	0.0242	Estimated in this study using 1990-92 data from (Courtney 1997)
December	0.0355	
January	0.0746	
February	0.0251	
March	0.0283	
April	0.0730	
May	0.1845	
June	0.0807	
July	0.1391	
August	0.1014	
September	0.1289	
October	0.1047	

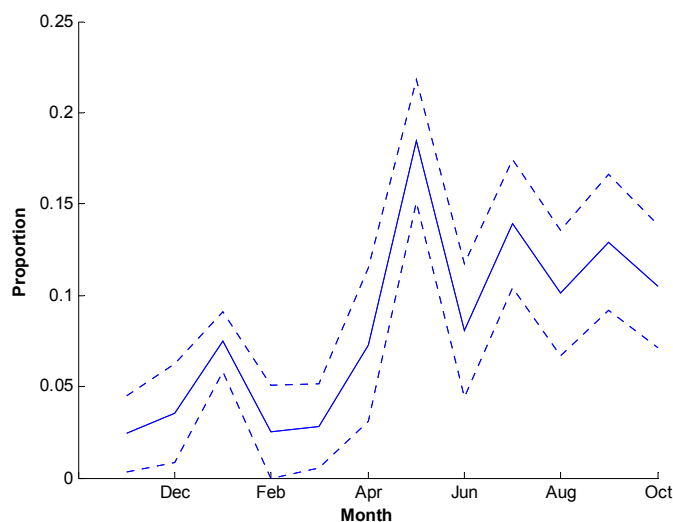
**Figure 8.4.1.3** Histological staging of female eastern king prawns showed that the relative proportion of spawning was higher between May and October. The dotted lines are 90% confidence intervals. The months are presented in order of a fishing year. Based on data from (Courtney 1997).

The stock assessment used two modelling approaches – a monthly delay difference model and an annual surplus production model (Figure 8.4.1.4 and Figure 8.4.1.5 respectively). The delay difference model compared three monthly rates of natural mortality (M) and fishing power, with their respective 90% confidence intervals (Figure 8.4.1.4). These plots were structured accordingly:

- a) The first row of plots (A, B and C) resulted from assuming $M = 0.20 \text{ month}^{-1}$, which, based on the literature, is likely to be the most accurate estimate of natural mortality (Table 8.4.1.1). The model used to generate plot C was considered to most accurately reflect reality and was therefore used as the base-case model.
- b) The second row of plots (D, E and F) resulted from assuming a comparatively low rate of natural mortality ($M = 0.12 \text{ month}^{-1}$) derived from and equal to the 90th percentile on a normal distribution with mean 0.2 and standard deviation of 0.05 (25%).
- c) The third row of plots (G, H and I) assumed a relatively high rate of natural mortality ($M = 0.28$) equal to the upper 90th^h percentile on a normal distribution with mean 0.2 and standard deviation of 0.05 (25%).
- d) The first column of plots resulted from incorporating a value of zero for the annual rate of increasing fishing power (i.e. no annual effort creep) in the assessment and the stock-recruitment relationship.
- e) The second column of plots resulted from incorporating relatively low levels of annual increase in fishing power. The annual increases were the lower 90% confidence interval of the estimate of fishing power increase for each year and therefore varied between years. Because the estimates of annual increase in fishing power differ between the shallow water and deep water sectors of the eastern king prawn fishery (see Chapter 6), estimates used in the models were weighted to take account of the relative distribution of effort throughout the entire fishery (including both New South and Queensland effort). These estimates of the increase in fishing power were incorporated in both the assessment and the spawner-recruitment relationship.
- f) The third column of plots resulted from using the annual median estimates of increase in fishing power, and again weighted to take account of the spatial distribution of fishing effort. These estimates are likely to be the most accurate estimates of annual increase in fishing power and were incorporated in both the assessment and the spawner-recruitment relationship.

Note the purpose of comparing different outputs was to highlight the dependences of certain biological parameters on estimates of fishing power. The base-case results should always be used for comparison.

The model generally predicted that biomass, expressed as a ratio to virgin exploitable stock biomass size, was stable between 1989 and 2000 (Figure 8.4.1.4). There was a notable increase in 2001 that reflected the increased reported catches and catch rates at that time. Even though the predicted biomasses were stable, under some scenarios (particularly column C) the model indicated the biomass was consistently below B_{MSY} (Figure 8.4.1.4). The stock-recruitment curves (Figure 8.4.1.6) and model were used to estimate the equilibrium virgin stock size (B_0), the population size that supports maximum sustainable yield (B_{MSY}), and the management quantities of maximum sustainable yield (MSY).

Details on the catch data used in the spawner-recruitment curves are shown in Table 8.4.1.5. Ninety-two percent of the recruitment and spawning daily catch records from 1970 to 1987 were recorded from between Fraser Island in the north and the New South Wales border to the south (Moreton Bay excluded). After 1987, slightly less data came from this area with about 75% during the recruitment period and 60% during the spawning period. Overall, the spawner recruitment relationship was based mostly on catch and effort data from Fraser Island to the New South Wales border producing a long time series of records (> 30 years). Only results from the Beverton-Holt form of the spawning-recruitment relationship were reported because they were very similar to those obtained using the Ricker curve. The measure of steepness, defined as the average productivity of recruitment at 20% of virgin spawning stock size (Haddon 2001), declined with increasing fishing power (Figure 8.4.1.6 and Table 8.4.1.2). Estimates of MSY were comparable ranging from 2 530 to 2 704 tonnes across all models (Table 8.4.1.2 and Table 8.4.1.3). However, the equilibrium estimates of fishing effort (E_{MSY} , $3/4E_{MSY}$ and $2/3E_{MSY}$) were reduced substantially when annual increases in fishing power were included in the modelling (Table 8.4.1.2).

Results for the surplus-production model are provided in Table 8.4.1.3. Due to the lack of contrast in the annual catch rates, the estimate for the model's population-growth parameter (r) was very high at 2.4. Values above one generally indicate that the stock has high intrinsic rate of increase, and as a result high levels of E_{MSY} were calculated. Note, less weight should be given to results from the surplus production models; their parameters are hard to associate precisely with observable biological processes (especially for penaeid prawn with a short life history of one to two years), and they do not accurately measure variations in recruitment (especially with no trend in annual catch rates).

Additional sensitivity analysis on the delay difference model showed that higher MSY was related to lower rates of natural mortality, but lower MSY was calculated for slower prawn growth rates or higher natural mortality rates (Table 8.4.1.4).

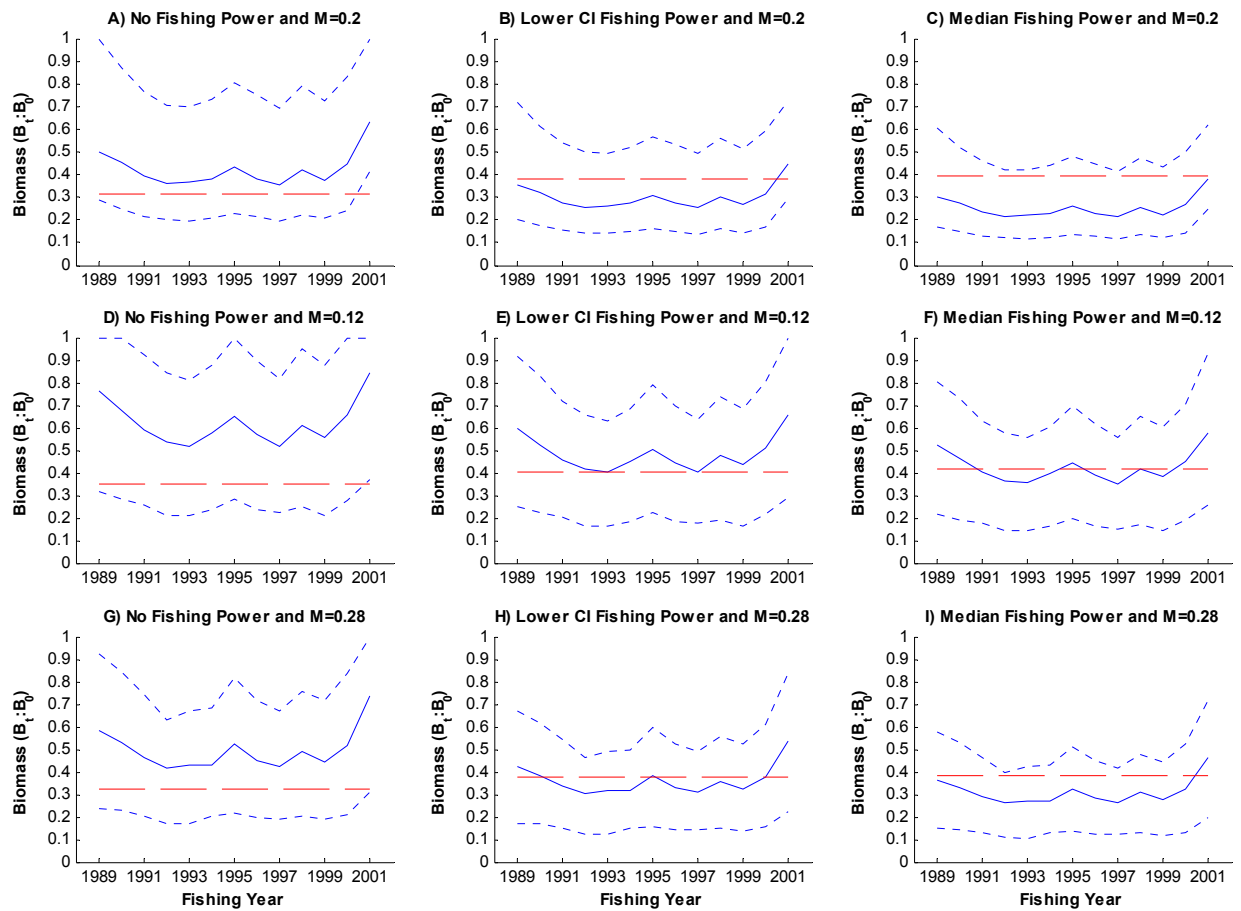

Figure 8.4.14 The monthly delay difference model predicted stable exploitable biomasses for the eastern king prawns between 1989 and 2000 fishing years, with a notable increase in 2001 (dotted lines represent the 90th percentiles). The results were presented for variations in fishing power, natural mortality and stock-recruitment. The dashed line shows the biomass reference point for maximum sustainable yield (B_{MSY}).

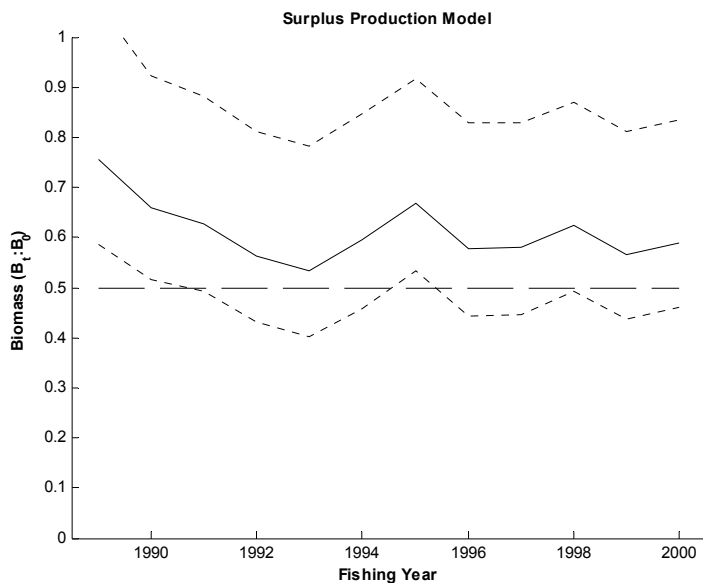

Figure 8.4.1.5 The annual surplus production model predicted stable exploitable biomasses for the eastern king prawns between 1990 and 2000 fishing years (dotted lines represent the 90th percentiles). The dashed line shows the biomass reference point for maximum sustainable yield (B_{MSY}).

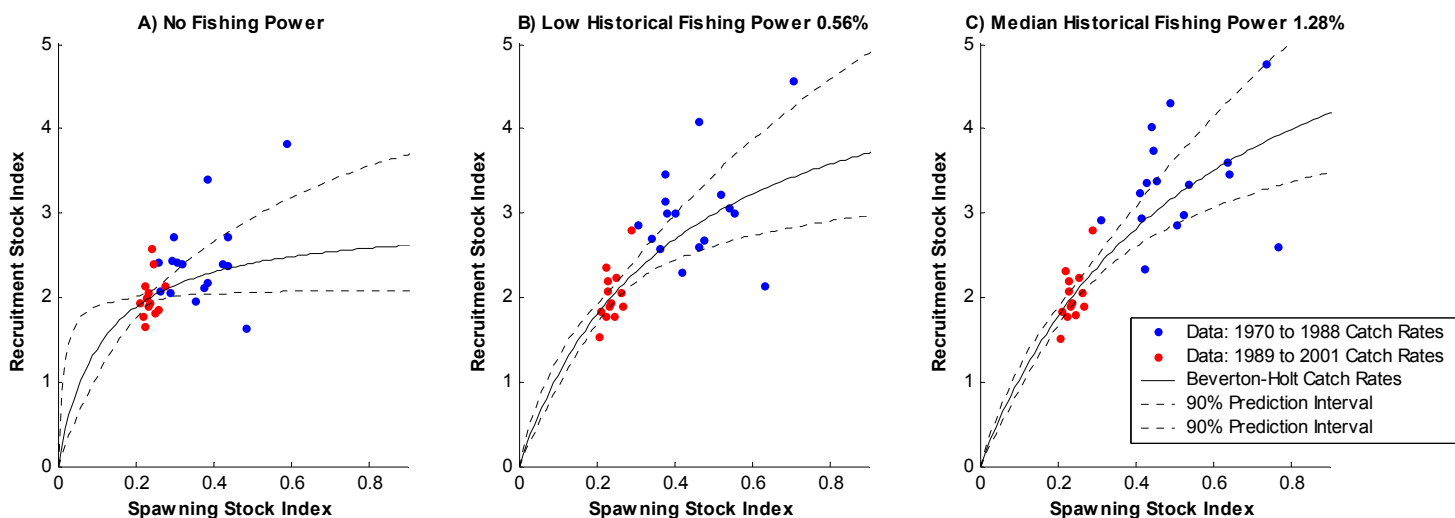

Figure 8.4.1.6 Eastern king prawn spawner-recruitment relationships assuming A) no fishing power increases, B) the lower 90% confidence interval for changes in the fishing power and C) the actual (best knowledge) estimate for changes in the fishing power. Note the rate of fishing power change listed on B) and C) were assumed proportional rates applied to the fishing years 1970 to 1988, based on the 1989 to 1999 trend in fishing power. One-year autocorrelations were non-significant at -0.072 ; the relationships were fit using a weighted log-likelihood.

Table 8.4.1.2 Eastern king prawn spawner-recruitment parameters and the delay-difference equilibrium management quantities for the base case biological parameters and three levels of fishing power. Numbers within brackets refer to the standard error and T statistic for the spawner-recruitment parameters and 90% confidence intervals for the Management parameters.

Parameters	No Fishing Power	Lower CI Fishing Power	Median Fishing Power
Spawner- Recruitment			
α	0.0384 (0.0175; 2.19)	0.0743 (0.0119; 6.22)	0.0839 (0.0098; 8.56)
β	3.3896e-9 (0.7134e-9; 4.75)	1.8676e-9 (0.4634e-9; 4.03)	1.4595e-9 (0.3682e-9; 3.96)
Steepness	0.56 (0.45:0.68)	0.40 (0.32:0.48)	0.37 (0.31:0.45)
Management			
MSY (tonnes)	2530 (1797:3392)	2704 (1802:3982)	2612 (1694:4065)
E_{MSY} (2001 nights)	47 487 (24 697:71 215)	31 744 (15 809:74 513)	25 664 (15 477:67 447)
$3/4 E_{MSY}$ (2001 nights)	35 615 (18 523:53 411)	23 808 (11 857:55 885)	19 248 (11 607:50 585)
$2/3 E_{MSY}$ (2001 nights)	31 626 (16 448:47 429)	19 516 (10 529:49 626)	17 109 (10 318:44 964)

Table 8.4.1.3 Summary of the parameters estimated from the surplus production model.

Parameter	Estimate (90% Confidence Interval)
Population Growth Rate r	2.395 (1.819:2.922)
Management Quantity	
MSY (tonnes)	2609 (2553:2729)
E_{MSY} (2001 nights)	44 381 (41 124:49 862)
$3/4 E_{MSY}$ (2001 nights)	33 286 (30 843:37 397)
$2/3 E_{MSY}$ (2001 nights)	29 587 (27 416:33 238)

Table 8.4.1.4 Additional delay-difference sensitivities based on varying the prawn growth parameter (ρ) and natural mortality (M).

Parameter; Fishing Power (FP)	MSY (tonnes)	E_{MSY} (2001 nights)
Slow Prawn Growth $\rho = 0.55$; median FP	2162	26 081
Slow Prawn Growth $\rho = 0.55$; lower CI FP	2090	32 226
Natural Mortality M = 0.12; lower CI FP	3193	50 104
Natural Mortality M = 0.28; lower CI FP	2437	30 677

Table 8.4.1.5 The number of daily catch records and weightings used to construct the spawner-recruitment curves; approximately 12% of data were from 1970 to 1987, the years 1981 to 1983 were excluded given the extreme paucity of data. The weightings were calculated using total records (recruitment + spawning)

Fishing Year	Recruitment Index (Nov to Feb)	Spawning Index (May to Aug)	Other Months	Total Records	Total Records (Recruitment + Spawning)	Weighting For Likelihood
1970	1099	447	1062	2608	1546	0.008
1971	786	1319	828	2933	2105	0.011
1972	810	1019	1015	2844	1829	0.010
1973	1331	1021	1393	3745	2352	0.012
1974	1011	1236	1431	3678	2247	0.012
1975	1597	1326	1230	4153	2923	0.015
1976	1292	1593	754	3639	2885	0.015
1977	542	801	527	1870	1343	0.007
1978	735	606	612	1953	1341	0.007
1979	693	626	634	1953	1319	0.007
1980	221	593	79	893	814	0.004
1981	7	227	9	243	234	0.000
1982	8	19	38	65	27	0.000
1983	19	19	30	68	38	0.000
1984	41	51	109	201	92	0.000
1985	81	87	62	230	168	0.000
1986	362	28	331	721	390	0.002
1987	486	393	374	1253	879	0.005
1988	1476	364	3735	5575	1840	0.010
1989	4788	3811	5301	13 900	8599	0.045
1990	6685	5672	5225	17 582	12 357	0.065
1991	6777	5479	6003	18 259	12 256	0.065
1992	7100	6292	6642	20 034	13 392	0.070
1993	7306	6434	5256	18 996	13 740	0.072
1994	6275	6602	5310	18 187	12 877	0.068
1995	7095	5796	5927	18 818	12 891	0.068
1996	7405	5877	6802	20 084	13 282	0.070
1997	8240	6298	6353	20 891	14 538	0.077
1998	7904	6214	7390	21 508	14 118	0.074
1999	6923	6880	6739	20 542	13 803	0.073
2000	6192	5439	4586	16 217	11 631	0.061
2001	6273	6388	4703	17 364	12 661	0.067
Total	101 560	88 957	90 490	281 007	190 517	1.000

For both the delay difference and surplus production model stock assessments there was no evidence to suggest the models were inadequate for the data or that the use of lognormal errors were inappropriate. Figure 8.4.1.7 shows that the models predicted the standardised catch rates quite well, although the monthly delay difference model tended to slightly underestimate four (out of 13) of the monthly peak catch rates present in the time series. The standardised residuals for these large catch rates were all less than four, indicating they were not extreme. The influence of these data points had little effect on the log-likelihood or upon the estimation of the parameters. For example, removing or slightly increasing their effect resulted in little change in the parameter estimates, suggesting the model captured these observations reasonably well and that it did accurately model the year-to-year and month-to-month patterns of eastern king prawns catch rates.

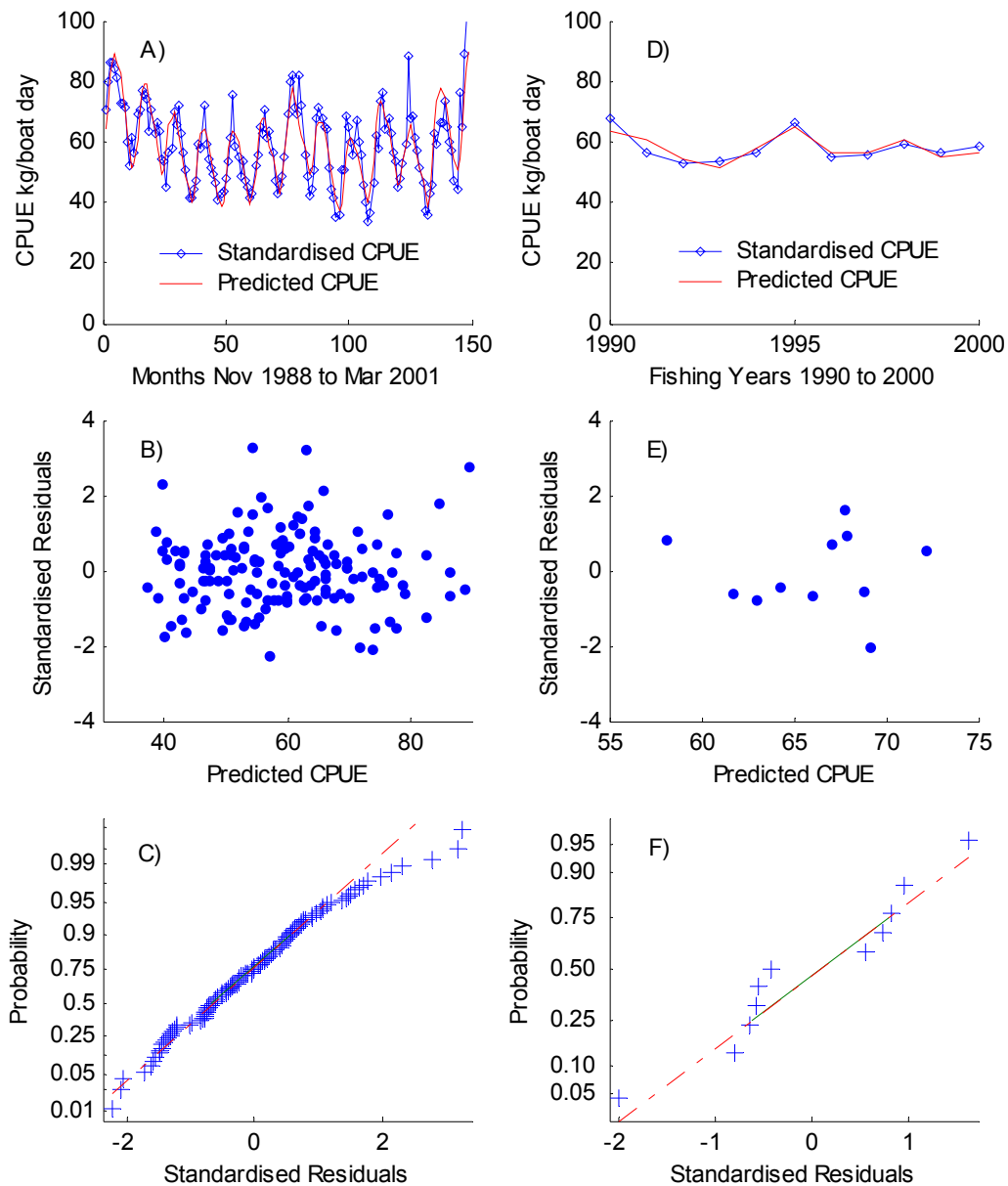

Figure 8.4.1.7 The delay difference (left side) and surplus production (right side) models predicted the observed standardised catch-rates well (A) and (D), and the use of log-normal errors was appropriate with no pattern in standardised residuals (B) and (E) and linear normality plots (C) and (F).

Reference Point Simulations

The reference points examined by the two models are provided in Table 8.3.10.1. A large number of results were generated from these simulations, especially as a result of considering the different assumptions made about recruitment. For example, recruitment was estimated with and without stock-recruitment relationships, and annual increases in fishing power. The results presented in this section focus on the performance of reference points through the delay difference model using the spawner-recruitment relationship with median fishing power (base case) (Figure

8.4.1.6C). Results from all simulations, covering a range of assumptions and scenarios in the modelling procedure, are tabulated in Appendix 15.1 and summarise forecasts for five-year and 20-year periods. Definitions used to interpret the simulations are listed under the Methods section 8.3.10. The simulations assess the consequences of using different reference points and management strategies and the subsequent results are presented in such a way as to allow the reader to evaluate the trade offs in performance. The results do not define a final reference point, management strategy or the status of the eastern king prawn stock, but rather they provide expected outcomes that may be used by decision makers to help select appropriate reference points to achieve the management objectives. It is important to note that the management objectives for the eastern king prawn fishery are yet to be defined.

Biological Performance

The model simulations suggested that higher biomass trajectories would be attained using $2/3 F_{MSY}$ and $3/4 F_{MSY}$ reference points (Figure 8.4.1.8). The 80% CPUE reference point, under the heavy one-way management intervention, would also result in relatively high biomass trajectories. Retaining the status quo, or adopting F_{MSY} as a reference point, generally resulted in relatively low biomass trajectories.

The probability trajectories for the biomass falling below 20% of the virgin stock biomass (B_0) and B_{MSY} were lowest under the 80% CPUE using a heavy one-way management strategy. Conversely, the probability of the biomass falling below 20% B_0 was highest when the F_{MSY} reference point was used.

Only the $2/3 F_{MSY}$ reference point and the 80% CPUE used under the heavy one-way management strategy ensured the biomass was above B_{MSY} with greater than 50% confidence. The other strategies and reference points failed this.

Industry Performance

The simulations indicate that using F_{MSY} as a biological reference point would likely lead to several detrimental conditions upon industry. For example, over the 20-year period forecast, catch trajectories declined, catch rate trajectories declined and annual catch variation increased (Figure 8.4.1.9). In contrast, trajectories associated with the $2/3 F_{MSY}$ and $3/4 F_{MSY}$ reference points resulted in increased catches, lower effort and higher CPUEs, although a significant drop in catch would likely result in the first five years.

The CPUE reference points under the heavy one-way management scenario all resulted in similar catch trajectories, with the 80% CPUE resulting in the highest trajectories for catch rate and the lowest trajectories for effort (Figure 8.4.1.9).

Management Performance

The number of triggered CPUE reference points was higher for the 80% CPUE reference point and lower for the 60% CPUE reference point (Figure 8.4.1.10). In other words, the higher the CPUE reference point the more likely it is to trigger. The CPUE reference points resulted in one to three corrections in fishing effort, over the 20 year forecast period, depending on the response mechanism (moderate or heavy) and the reference point (60%, 70% or 80% CPUE). Generally, the $3/4$ and $2/3 F_{MSY}$ reference points resulted in one significant correction in fishing effort (Figure 8.4.1.9).

The CPUE reference points typically triggered at low biomass levels ranging between 10% and 40% of virgin stock size (B_0) (Figure 8.4.1.11). All simulations of the CPUE reference points highlighted they can falsely trigger at large biomasses (Figure 8.4.1.11). The simulations were based on the base-case model stock assessment where the spawner-recruitment curve incorporated the median estimates of annual fishing power increase (Figure 8.4.1.4C). This plot indicates that the CPUE reference points were based on catches between 1989 and 1997 when the population biomass was at 25–30% B_0 . Consequently, the management performance of the CPUE reference points often fails to trigger at low biomasses around 20% B_0 (Table 8.4.1.6). This is because the 60%, 70%, or 80% CPUE reference points typically relate to biomasses lower than 20% B_0 . For example, the 70% moderate one-way management strategy only correctly triggered for 32% of the biomasses that were below 20% B_0 (Figure 8.4.1.11). Even lower accuracy resulted from using the 60% CPUE reference point. The accuracies were extremely low if CPUE reference points were used to manage biomasses around B_{MSY} (Table 8.4.1.6). No significant quadratic effects of changing trigger accuracy were found for different levels of fishing effort ($p > 0.05$).

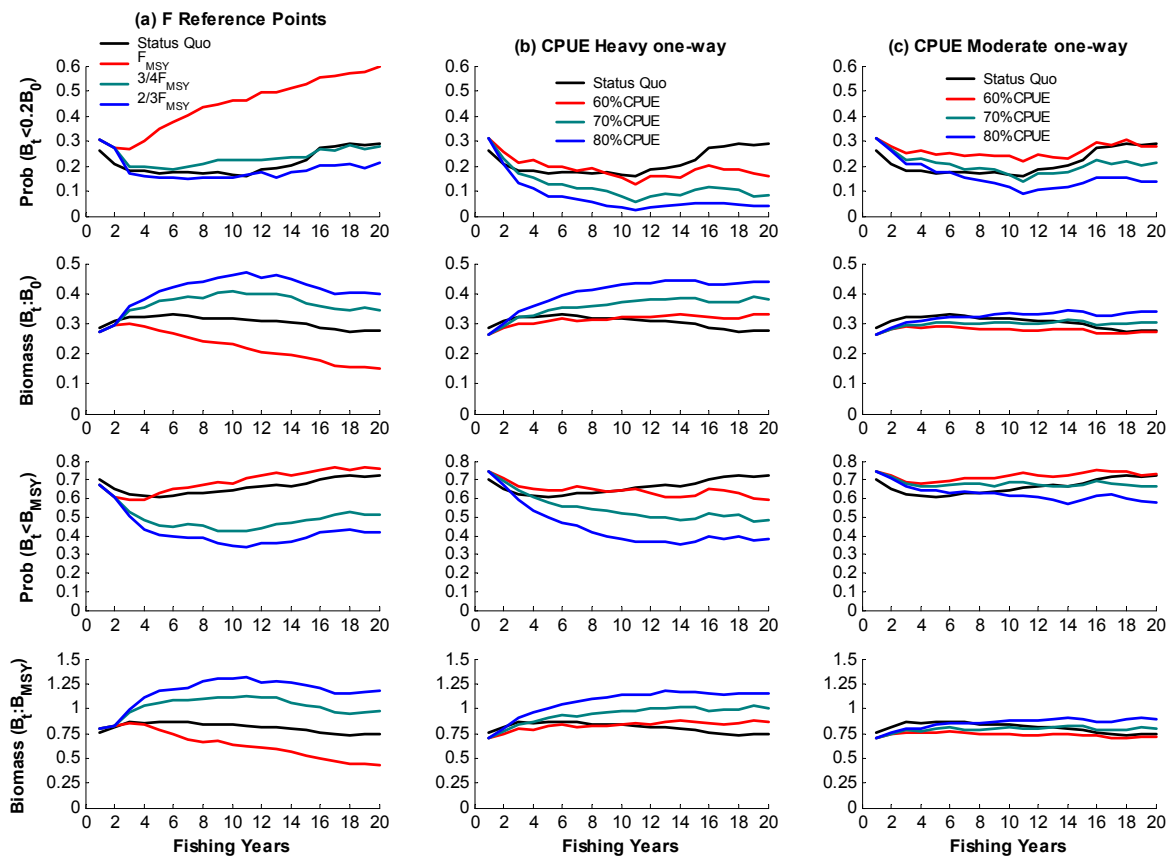

Figure 8.4.1.8 The expected biological outcomes for eastern king prawns from managing fishing effort according to, (a) fishing mortality, (b) heavy one-way catch-rate, and (c) moderate one-way catch rate reference points. The first two rows of plots illustrate the outcomes in relation to virgin population size (B_0). Outcomes on the bottom two rows were measured against the population size which supports maximum sustainable yield (B_{MSY}). Lower probabilities (or risks) of the population sizes falling below $0.2B_0$ and B_{MSY} were for fishing efforts managed at 2/3 of MSY effort or 80% heavy one-way catch-rates. Probabilities at 0.5 represent the population sizes at $0.2B_0$ and B_{MSY} respectively. The one-way and two-way catch-rate management strategies performed alike. The results assume Beverton-Holt recruitment; status quo represents 35 000 days of fishing effort with no management changes.

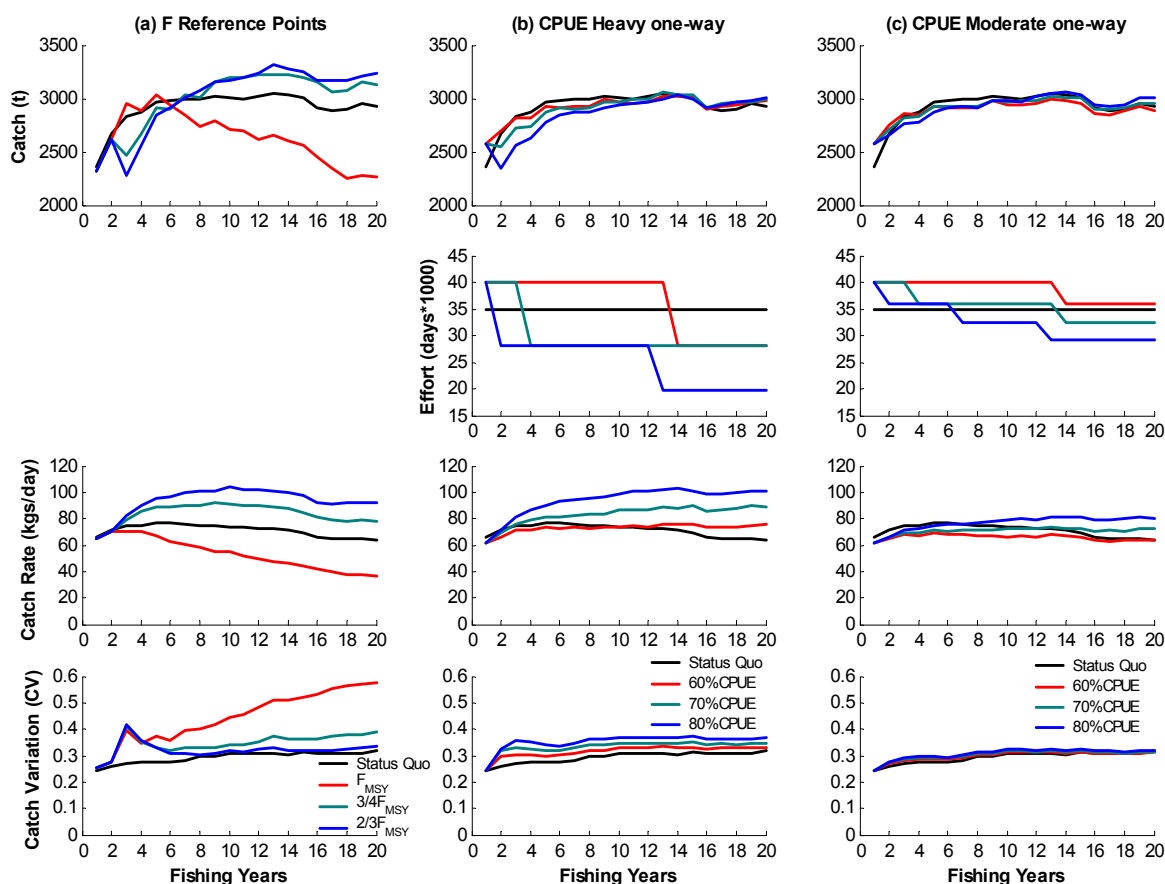

Figure 8.4.1.9 The expected industry outcomes from fishing eastern king prawns and managing fishing effort according to, (a) fishing mortality, (b) heavy one-way catch-rate, and (c) moderate one-way catch-rate reference points. Industry outcomes were measured against median total catches, fishing effort, catch-rates and variation in total catches (coefficient of variation). Generally, the management strategies of 3/4 and 2/3 of MSY fishing effort produced larger catches and catch-rates in the long term. Variations in total catches were similar for all management strategies, but much larger for fishing at MSY. The one-way and two-way catch-rate management strategies performed alike. The results assume Beverton-Holt recruitment; status quo represents 35 000 days of fishing effort with no management changes.

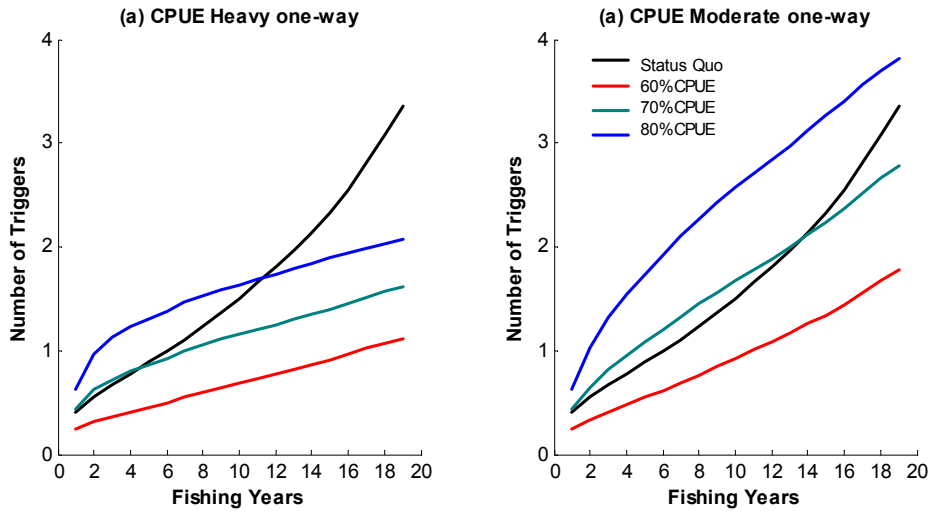

Figure 8.4.1.10 The average cumulative number of management changes (limit catch-rate triggers) for the (a) heavy one-way catch-rate, and (b) moderate one-way catch-rate reference points. Generally over twenty years, between one and two catch-rate triggers will occur under the heavy one-way management strategy, but up to three or four may occur under moderate one-way management strategy. Again, the one-way and two-way catch-rate management strategies performed alike. The results assume Beverton-Holt recruitment; status quo represents the number of catch-rates falling below 70% CPUE for 35 000 days of fishing effort with no management changes.

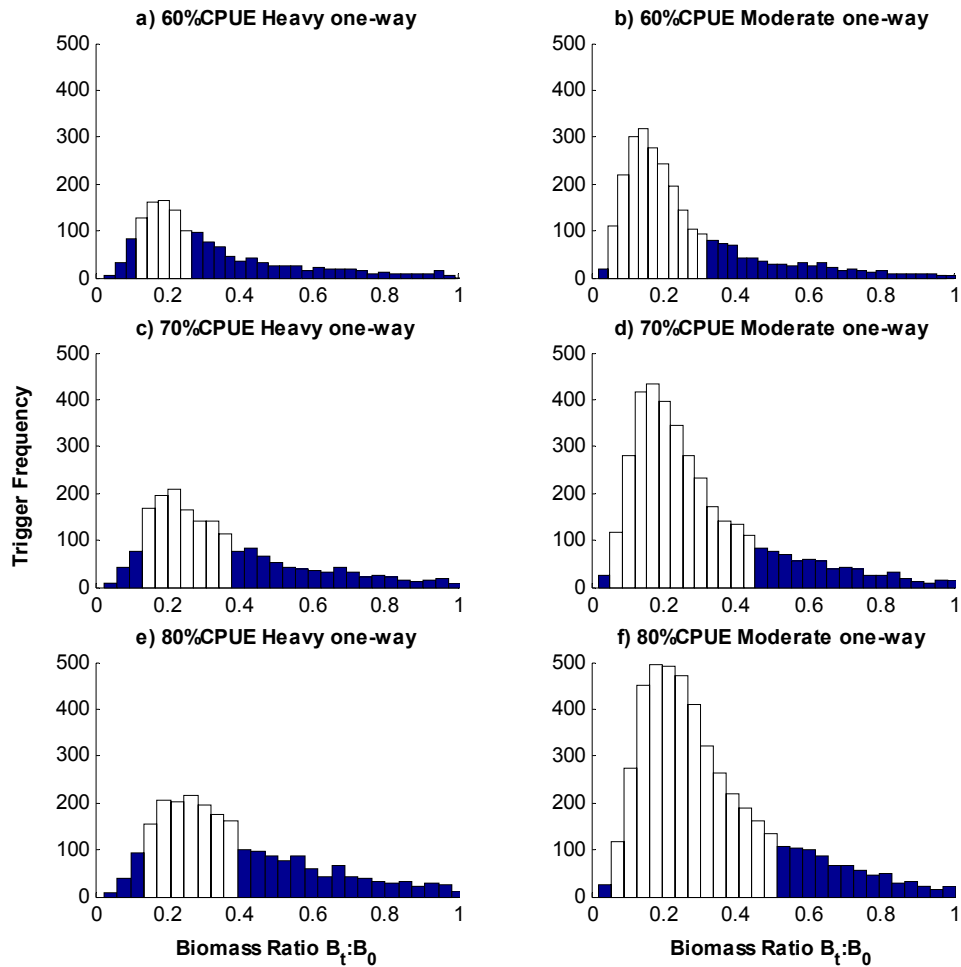

Figure 8.4.1.11 The distribution of CPUE reference points triggering under a range of exploitable biomasses, expressed as a ratio of virgin biomasses. The results are shown from the monthly delay difference model for 45 000 test-fishing days of effort, assuming Beverton-Holt recruitment. The catch-rate reference points triggered more frequently under the moderate one-way management strategy and trigger at marginally lower population sizes due to the slow response of this management strategy to change fishing effort.

Table 8.4.1.6 The accuracy of catch-rate reference points for 45 000 test-fishing days of effort, assuming Beverton-Holt recruitment. The higher probabilities for the 80% CPUE and moderate one-way management strategy indicate better accuracy measured against the biomass reference levels of $0.2B_0$ and B_{MSY} .

Reference Point	Management Strategy	Proportion of Triggers Accurately detecting	Proportion of Triggers Accurately detecting	Actual Biomass (B_t/B_0) at Trigger		
		when $B_t < 0.2B_0$	when $B_t < B_{MSY}$	5%ile	Median	95%ile
60% CPUE	Heavy one-way	0.14	0.09	0.10	0.24	0.75
60% CPUE	Moderate one-way	0.24	0.15	0.07	0.19	0.67
70% CPUE	Heavy one-way	0.22	0.12	0.11	0.29	0.80
70% CPUE	Moderate one-way	0.32	0.21	0.09	0.24	0.71
80% CPUE	Heavy one-way	0.32	0.17	0.13	0.33	0.84
80% CPUE	Moderate one-way	0.43	0.27	0.10	0.27	0.74

8.4.2 Torres Strait Tiger Prawns

Catch Statistics

The total catch of brown tiger (*Penaeus esculentus*) and blue endeavour prawns (*Metapenaeus endeavouri*) in Torres Strait since 1978 is illustrated in Figure 8.4.2.1. Although brown tiger prawns are the primary target species, the blue endeavour prawns are the largest component of the catch. The two species coexist in the same area and there are only a few records (< 0.5%) where no tiger prawns were recorded in the daily vessel catch. The average annual tiger prawn catch since 1989 is 634 tonnes and has ranged from about 396 tonnes in 1990 to 965 tonnes in 1998. The average number of days fished is 9 289 and has ranged from 5 688 days in 1990 to 11 907 days in 1992. The average annual catch of tiger prawns for the years 1978 to 1988 is 442 tonnes and ranges from 280 tonnes in 1978 to 685 tonnes in 1985 (Figure 8.4.2.1). Figure 8.4.2.1 also summarises the total tiger and endeavour prawn catch for the years 1978 to 1988 based on unloading records, compared to compulsory logbook reporting post-1988. The estimated total effort for the years 1978–88 is based on the average tiger prawn CPUE from logbook records for the years 1980 to 1988 (97.6 kg per day). The average tiger prawn CPUE for the years 1989–2002 is 70.4 kg/day. Average fishing-power standardised catch rates show consistent seasonal declines from March through to November, with an overall declining trend evident from 1980 to 1994, followed by a period of stable catch rates to 2002 (Figure 8.4.2.2). In 1991 the east of Warrior spatial/seasonal closure was introduced to stop growth overfishing. This aimed to prevent fishing of the smaller sized prawns that tend to occur close to the eastern side of Warrior Reef between the months of December and July inclusive.

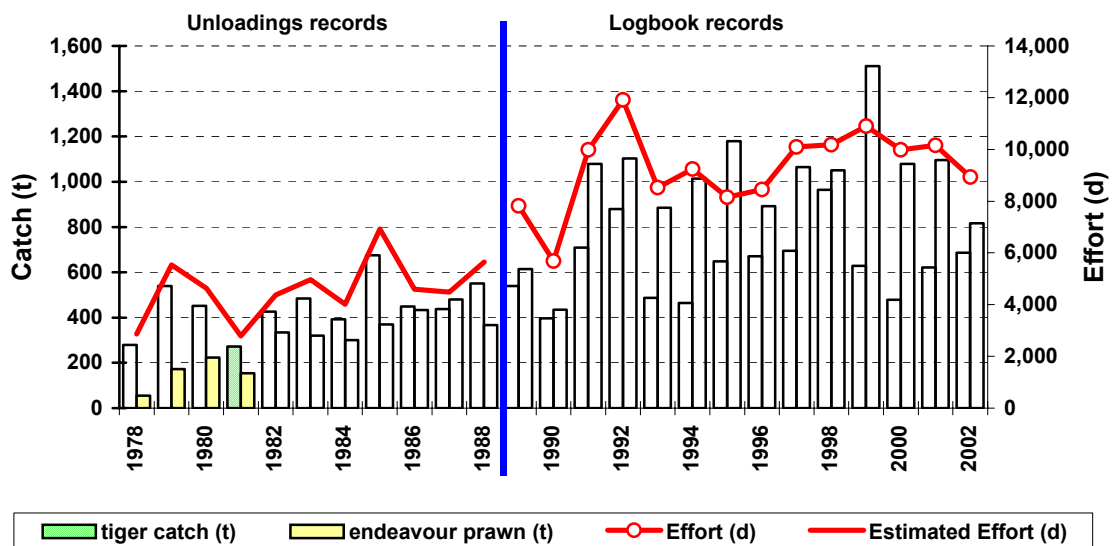

Figure 8.4.2.1 The Torres Strait tiger and endeavour prawn catch and total fishing effort recorded between 1978 and 2002.

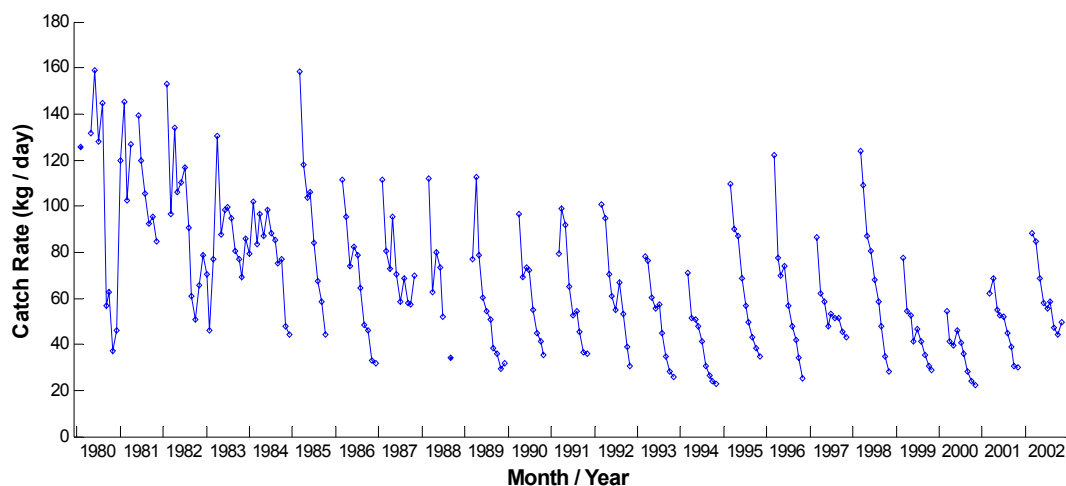

Figure 8.4.2.2 Monthly standardised Torres Strait tiger prawn catch rates from 1980 to 2002; note the seasonal declines in catch rates and the overall gradual annual decline. The gaps in catch rates relate to the three-month seasonal closure.

Biological Data

Table 8.4.2.1 contains a summary of the biological inputs used to calculate average prawn growth, weight, size at first recruitment to the fishery and one month prior, natural mortality and the relative monthly spawning pattern for the brown tiger prawn (*P. esculentus*) in the Torres Strait. These biological parameters are deterministic, and the model sensitivity to these parameters is reported as part of the stock assessment. The parameters represent the base-case against which the model sensitivities are measured.

Note that there were several growth estimates based on animals tagged to the east and west of Warrior Reef and also two tagging experiments, 1987 and 1988 (Watson and Turnbull 1993). The growth parameters for male and female prawns tagged and recaptured east of the Warrior Reef in 1987 were used as they are based on a larger sample size than for 1988. In addition, examination of the 95% confidence regions for the growth parameters of females prawns tagged and recaptured east of the Warrior Reef in 1987 were in between the west 1987 and 1988 estimates. Similarly the male growth rates east in 1987 estimate overlaps the 1988 and 1987 region. For these reasons we considered them to be the most representative estimates to use.

The measure of relative spawning was calculated by analysing an index of population fecundity (PFI), which is the relative number of eggs produced or potentially produced by the population each month (Keating et al. 1990). The PFI used to estimate the monthly spawning pattern was based on the number of female brown tiger prawns with mature ovaries per square metre of seabed swept by the trawl nets, their length distribution and the fecundity to carapace length relationship. In addition the probability of insemination of ripe females was incorporated into the PFI calculations (Keating et al. 1990). This index was estimated from monthly trawl survey data collected in Torres Strait during 1986-1991. The mean PFI by year, month and region was used in a General Linear Model to estimate the monthly pattern with region (west of Warrior Reef, east of Warrior Reef, Fishery) as a factor in the model. Generally the relative amount of spawning was greatest in January and February

(Figure 8.4.2.3). This result was used with the population estimates in the model to calculate spawning stock sizes.

Table 8.4.2.1 Torres Strait tiger prawn parameters used as biological inputs into the monthly delay difference model.

Parameters	Estimates	Data Sources
<i>Von Bertalanffy Prawn Growth</i>		
$L_{\infty}k$ (male)	34.7 CL mm; 0.2417 month ⁻¹	(Watson and Turnbull 1993)
$L_{\infty}k$ (female)	43.6 CL mm; 0.2167 month ⁻¹	
<i>Brody Prawn Growth</i>		
ρ (sexes combined)	0.90865166	As above
<i>Carapace Length to Weight</i>		
$w_{grams} = aCL^b$		
a_{male}, b_{male}	0.0024, 2.72	(Watson 1990)
a_{female}, b_{female}	0.0026, 2.67	
<i>Carapace Length at Recruitment</i>		
Male	24 mm	(Watson 1990), and
Female	28 mm	(Watson and Turnbull 1993)
<i>Natural Mortality (M)</i>		
	0.2	(Watson 1990) and (Garcia 1985)
<i>Monthly Spawning Pattern (Proportion, β)</i>		
January	0.1055	Estimated in this study using 1986–91 data from (Watson and Turnbull 1993)
February	0.1022	
March	0.0823	
April	0.0746	
May	0.0764	
June	0.0543	
July	0.0760	
August	0.0880	
September	0.0789	
October	0.0965	
November	0.0808	
December	0.0847	

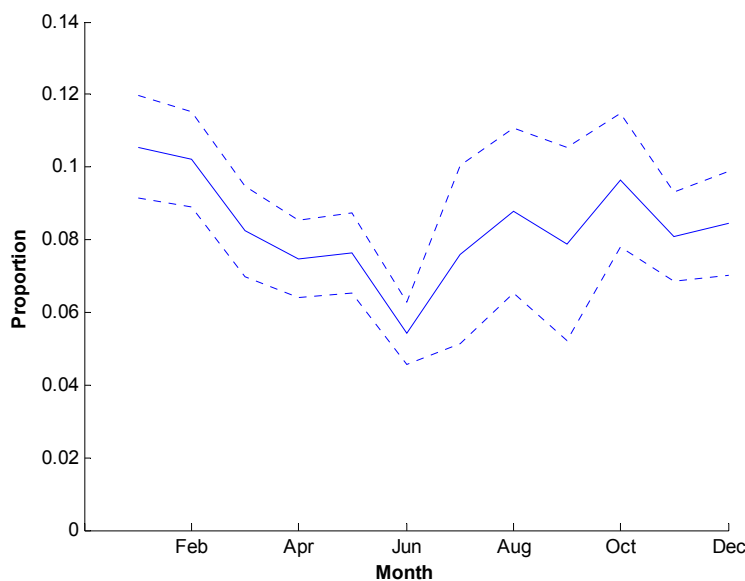

Figure 8.4.2.3 Histological staging of female tiger prawns in the Torres Strait showed no clear peaks in relative spawning, but was marginally highest in January and February. The dotted lines are 90% confidence intervals.

Stock Assessment

The stock assessment used two modelling approaches – a monthly delay difference model and an annual surplus production model (Figure 8.4.2.4 and Figure 8.4.2.5 respectively). The delay difference model compared biomass trends, with their respective 90% confidence intervals, for three monthly rates of natural mortality (M) using the annual median estimates of increase in fishing power (Figure 8.4.2.4). Figure 8.4.2.4A resulted from assuming $M = 0.20 \text{ month}^{-1}$, which based on the literature, is likely to be the most accurate estimate of natural mortality (Table 8.4.2.1). Figure 8.4.2.4B resulted from assuming a comparatively low rate of natural mortality ($M = 0.12 \text{ month}^{-1}$) derived from and equal to the 90th percentile on a normal distribution with mean 0.2 and standard deviation of 0.05 (25%). Figure 8.4.2.4C assumed a relatively high rate of natural mortality ($M = 0.28$) equal to the upper 90th percentile on a normal distribution with mean 0.2 and standard deviation of 0.05 (25%).

The purpose of comparing different outputs was to highlight the dependences of natural mortality. The base-case results should always be used to compare dependences (Figure 8.4.2.4A).

The monthly delay difference model generally predicted that biomass, expressed as a ratio to virgin exploitable stock biomass size, declined between 1980 and 1994, but varied around B_{MSY} between 1995 and 2002 (Figure 8.4.2.4). Under all scenarios the delay difference model indicated the 2002 biomass was at or just above B_{MSY} (Figure 8.4.2.4). The Ricker stock-recruitment curve and model were used to estimate the equilibrium virgin stock size (B_0) and the population size that supports maximum sustainable yield (B_{MSY}).

Both the Ricker and Beverton-Holt forms of the spawning-recruitment relationship were reported because their optimal curve fits varied at low spawning stock sizes

(Figure 8.4.2.6). The measure of steepness, defined as the average productivity of recruitment at 20% of virgin spawning stock size, was statistically more significant for the Ricker curve with tighter confidence intervals (Figure 8.4.2.6 and Table 8.4.2.2). Estimates of MSY and E_{MSY} were 611 and 698 tonnes, and 7228 and 8257 boat nights, for the Ricker and Beverton-Holt spawner-recruitment relationships respectively (Table 8.4.2.2). The equilibrium estimates of fishing effort (E_{MSY}) were substantially higher when annual increases in fishing power were excluded (Table 8.4.2.2). Additional sensitivity analysis on the delay difference model showed that the calculations of MSY and E_{MSY} were not dramatically sensitive to different assumptions of natural mortality and prawn growth (Table 8.4.2.3). However, E_{MSY} was sensitive to different annual increases in fishing power and the form of spawner-recruitment relationship, with lower estimates associated with higher fishing power and the Ricker curve (Table 8.4.2.3).

Results for the surplus-production models are provided in Figure 8.4.2.5 and Table 8.4.2.4. The surplus production models compared biomass trends using all data (partial logbook data 1980 to 1988 and compulsory logbook data 1989 to 2002; Figure 8.4.2.5A and B) and only the compulsory logbook data (Figure 8.4.2.5C and D). The ‘constrained’ models included a penalising term in the log-likelihood to minimise the probability that the starting biomass (1980 or 1989) was greater than the estimated virgin stock size. All model parameters were estimated freely in the ‘unconstrained’ model. All models predicted a declining exploitable biomass for Torres Strait tiger prawns, and the 2002 biomass was at about B_{MSY} (Figure 8.4.2.5). Calculations of MSY were comparable across model runs (Table 8.4.2.4). However, the levels of fishing effort that should give rise to the MSY were much higher compared with the delay difference model estimates. Additional surplus production analyses using all data resulted in similar management quantities (Table 8.4.2.5). Note that the Fox and Pella-Tomlinson management quantities were quite similar as the Pella-Tomlinson asymmetry parameter (m) tended towards zero ($m < 0.00001$).

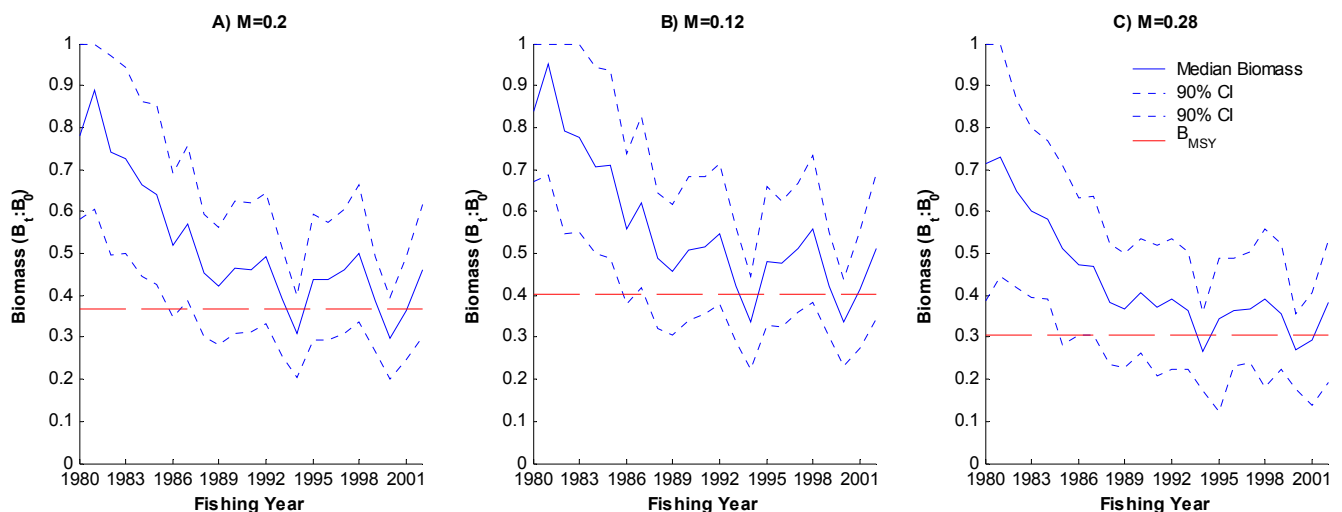

Figure 8.4.2.4 The monthly delay difference model predicted declining exploitable biomasses for Torres Strait tiger prawns between 1980 and 1994. Since 1995, biomasses varied around the biomass reference point for maximum sustainable yield (B_{MSY} the dashed line). The results were presented for three variations in natural mortality (M); B_{MSY} calculated from Ricker curve. The dotted lines represent the 90th percentiles. Annual median increases in fishing power were assumed.

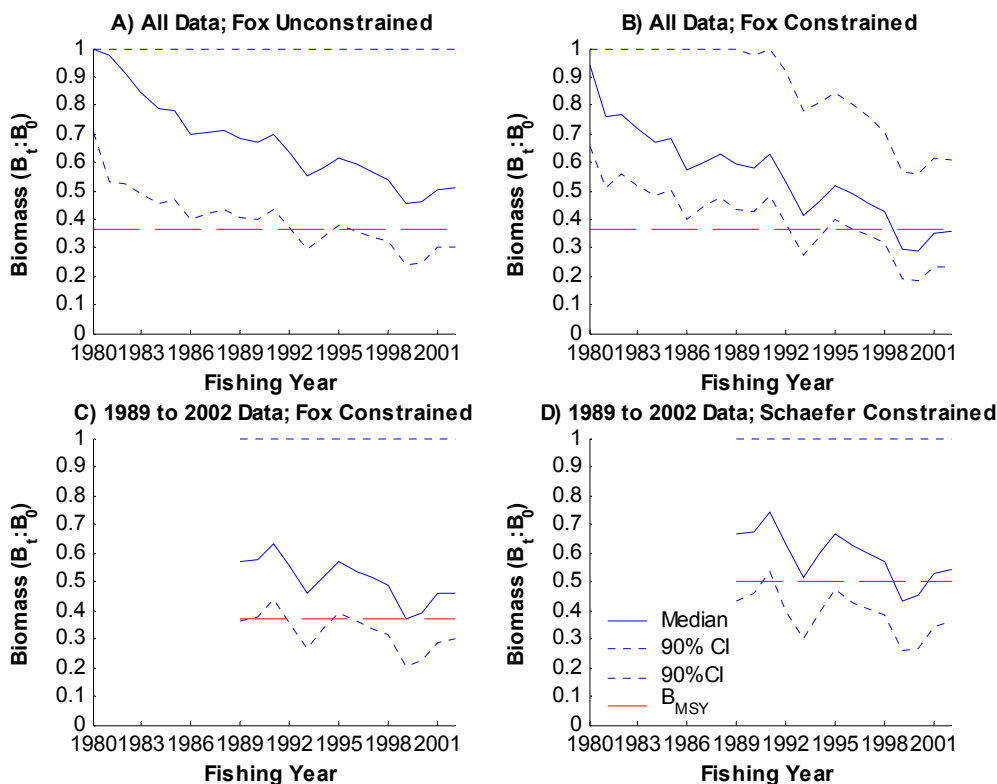

Figure 8.4.2.5 The annual surplus production models predicted declining exploitable biomasses for Torres Strait tiger prawns, for A) the Fox form of surplus production using all data and a unconstrained log-likelihood, B) the Fox form of surplus production using all data and a constrained log-likelihood, C) the Fox form of surplus production using only 1989 to 2002 data and a constrained log-likelihood, and D) the Schaefer form of surplus production using only 1989 to 2002 data and a constrained log-likelihood (the dotted lines represent the 90th percentiles). The dashed lines show the biomass reference point for maximum sustainable yield (B_{MSY}).

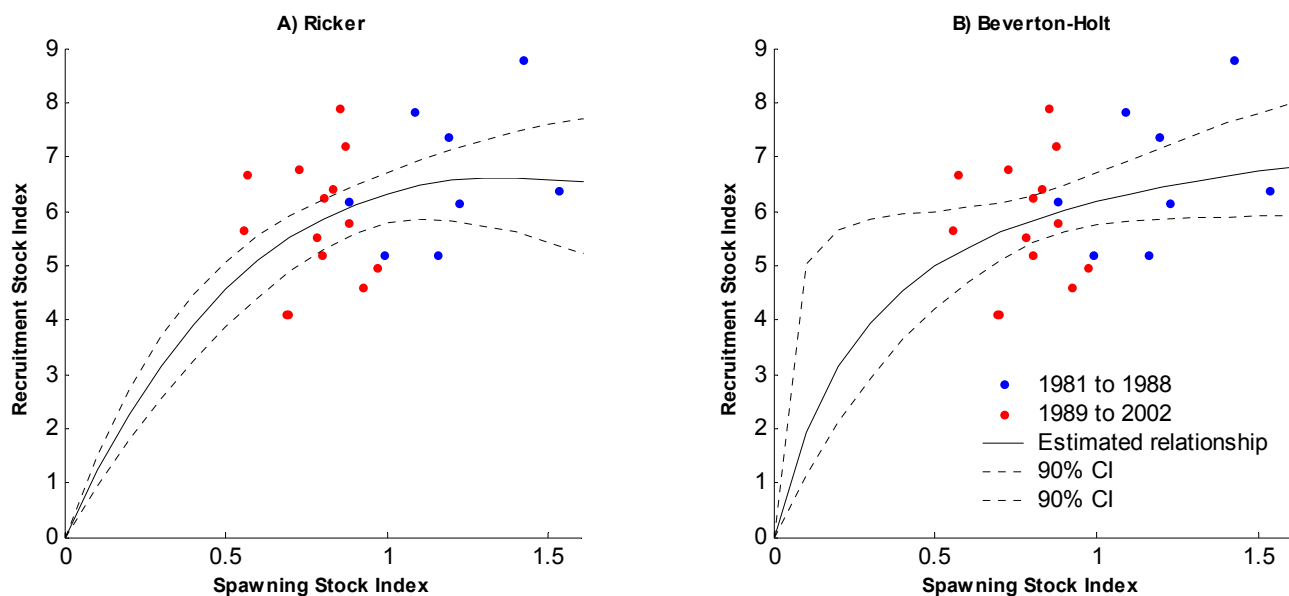

Figure 8.4.2.6 Torres Strait tiger prawn spawner-recruitment relationship assuming A) the Ricker form or B) the Beverton-Holt form. One-year autocorrelations were non-significant at -0.085 .

Table 8.4.2.2 Torres Strait tiger prawn spawner-recruitment parameters and the delay difference equilibrium management quantities. Numbers within the parentheses refer to the standard error and T statistic for the spawner-recruitment parameters and 90% confidence intervals for the steepness and management parameters.

Parameters	Ricker	Beverton-Holt
Spawner-Recruitment		
α	13.1272 (2.0984; 6.26)	0.0393 (0.0240; 1.64)
β	7.2969e-8 (1.6658e-8; 4.38)	1.2228e-8 (0.2759; 4.43)
Steepness	0.44 (0.32:0.64)	0.56 (0.37:0.93)
Management		
MSY (tonnes)	611 (426:808)	698 (490:958)
E_{MSY} (2002 boat nights)	7228 (5040:9559)	8257 (5797:11333)
$\frac{3}{4} E_{MSY}$ (2002 boat nights)	5421 (3780:7169)	6192 (4347:8499)
$\frac{2}{3} E_{MSY}$ (2002 boat nights)	4818 (3360:6372)	5504 (3864:7555)
E_{MSY} (no fishing power increases; 1980 nights)	8935 (6230:11816)	10 207 (7165:14009)

Table 8.4.2.3 Additional delay-difference sensitivities based on varying the prawn growth parameter (ρ), natural mortality (M), and fishing power increases.

Parameters	Ricker		Beverton-Holt	
	MSY	E_{MSY} (2002 nights)	MSY	E_{MSY} (2002 nights)
Fast Prawn Growth $\rho = 0.97$	630	7453	702	8305
Slow Prawn Growth $\rho = 0.53$	722	8541	769	9097
Low Natural Mortality $M = 0.12$	616	7287	705	8340
High Natural Mortality $M = 0.28$	619	7323	677	8009
Lower CI Fishing Power	622	7843	700	8827
Higher CI Fishing Power	606	6729	668	7417

Table 8.4.2.4 Summary of equilibrium management parameters estimated from the surplus production models.

Parameter	Fox Unconstrained; All Data	Fox Constrained; All Data	Fox Constrained; 1989 to 2002 Data	Schaefer; 1989 to 2002 Data
Population Growth Rate r	0.467 (0.159:0.735)	0.669 (0.311:0.920)	0.634 (0.143:1.010)	1.135 (0.333:1.721)
Management Quantity				
MSY (tonnes)	681 (594:773)	643 (607:689)	671 (581:803)	660 (549:708)
E_{MSY} (2002 boat nights)	14 555 (12 182:21 052)	11 353 (8548:12 806)	12 140 (6755:19 951)	10 388 (7553:13 205)
$\frac{3}{4} E_{MSY}$ (2002 boat nights)	10 916 (9137:15 789)	8514 (6411:9604)	9308 (5066:14 941)	7791 (5665:9903)
$\frac{2}{3} E_{MSY}$ (2002 boat nights)	9703 (8121:14 035)	7569 (5699:8538)	8273 (4503:13281)	6925 (5036:8804)

Table 8.4.2.5 Additional surplus production equilibrium management estimates using all data.

Model	MSY (tonnes)	E_{MSY} (2002 nights)
Pella-Tomlinson; Unconstrained	680	14 510
Pella-Tomlinson; Constrained	625	11 001
Schaefer; Unconstrained	593	10 586

For both the delay difference and surplus production model stock assessments there was no evidence to suggest the models were inadequate for the data or that the use of lognormal errors were inappropriate. Figure 8.4.2.7 shows that the models predicted the standardised catch rates quite well, although the monthly delay difference model tended to slightly under estimate about eight (out of 23) of the monthly peak catch rates present in the time series. The standardised residuals for these large catch rates

were all less than four, indicating they were not extreme. There was one notable large residual of -4.97 from February 1983. This standardised catch-rate was unusually low at 46 kg/day, but the model calculated this at 106 kg/day, as catch-rates were typically largest in February and March. The influence of such data points had little effect on the log-likelihood or upon the estimation of the parameters. For example, removing or slightly increasing their effect resulted in little change in the parameter estimates, suggesting the model captured these observations reasonably well and that it accurately modelled the year-to-year and month-to-month patterns of tiger prawn catch rates. There was a slight pattern present in the standardised residuals from the Fox model using a penalised log-likelihood. Catch rates from 1987 to 1991 were all slightly over-estimated, but these residuals were not large.

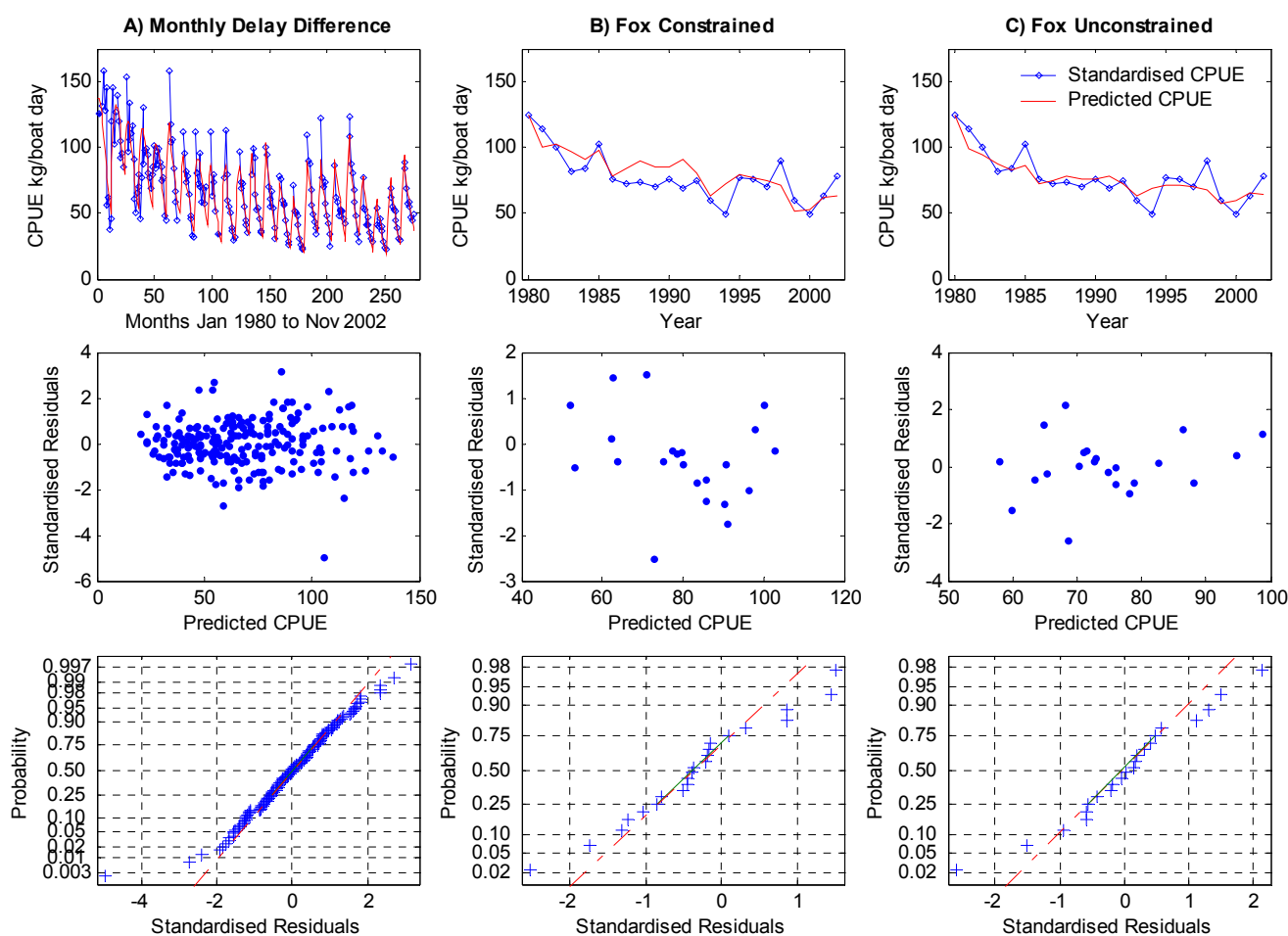

Figure 8.4.2.7 The delay difference (left), Fox surplus production with constrained log-likelihood (middle), and Fox surplus production with unconstrained log-likelihood (right) models captured the trend in standardised catch-rates quite well (1st row of plots), the use of log-normal errors was appropriate with no clear pattern in standardised residuals (2nd row plots), and linear normality plots (3rd row).

Reference Point Simulations

The reference points examined by the two models are provided in Table 8.3.10.1. A large number of results were generated from these simulations, especially as a result

of considering the different assumptions made about recruitment. For example, recruitment was estimated with Ricker and Beverton-Holt stock-recruitment relationships. The results presented in this section focus on the performance of reference points through the delay difference model using the Ricker spawner-recruitment relationship with median annual increases in fishing power (base-case) (Figure 8.4.2.6A). Results from all simulations, including these, are tabulated in Appendix 15.1 and summarise forecasts for five-year and 20-year periods. Definitions used to interpret the simulations are listed under the methods section 8.3.10, page 101. The simulations assess the consequences of using different reference points and management strategies and the subsequent results are presented in such a way as to allow the reader to evaluate the trade offs in performance. The results do not define a final reference point, management strategy or the status of the Torres Strait tiger prawn, but rather they provide expected outcomes that may be used by decision makers to help select appropriate reference points to achieve the management objectives. It is important to note that the management objectives for trawling in the Torres Strait prawn fishery are being revised. The current objectives do not define target or limit reference points or management responses that could be used to restrict fishing effort to levels that are sustainable. This research is timely and provides a starting point for discussion of potential reference points and management strategies.

Biological Performance

The model simulations suggested that higher biomass trajectories would be attained using the 80% CPUE reference point, under the heavy one-way management intervention (Figure 8.4.2.8). The $2/3 F_{MSY}$, $3/4 F_{MSY}$, and other CPUE reference points, also resulted in relatively high biomass trajectories. Retaining the status quo, or adopting F_{MSY} as a reference point generally resulted in lower biomass trajectories.

The probability trajectories for the biomass falling below 20% of the virgin stock biomass (B_0) and B_{MSY} were lowest under the CPUE reference points using a heavy one-way management strategy. Conversely, the probability of the biomass falling below 20% B_0 was highest when status quo fishing effort was retained and when the F_{MSY} reference point was used.

All the $2/3 F_{MSY}$, $3/4 F_{MSY}$, 70% and 80% CPUE reference points and management strategies ensured the biomass was above B_{MSY} with greater than 50% confidence. The F_{MSY} , status quo, and 60% CPUE with moderate one-way management intervention strategies failed this.

Industry Performance

The simulations indicate that status quo fishing and all reference points would likely lead to similar tiger prawn catches for industry, although a drop in catch would likely result from the lower fishing effort strategies in the first five years (Figure 8.4.2.9). The CPUE reference points all resulted in similar catch trajectories, with the 80% CPUE under the heavy one-way management scenario resulting in the highest trajectories for catch rate and the lowest trajectories for effort (Figure 8.4.2.9). Status quo fishing and the F_{MSY} reference point resulted in higher fishing effort and the lowest catch rates. The variations in total catches (CV) were similar for all fishing strategies.

Management performance

The number of triggered CPUE reference points was higher for the 80% CPUE reference point and lower for the 60% CPUE reference point (Figure 8.4.2.10). In other words, the higher the CPUE reference point the more likely it was to trigger. The CPUE reference points resulted in four to eight corrections in fishing effort over the 20-year forecast, depending on the response mechanism (moderate or heavy) and the reference point (60%, 70% or 80% CPUE). Generally, the $3/4$ and $2/3$ F_{MSY} reference points resulted in one significant correction in fishing effort (Figure 8.4.2.9).

The CPUE reference points typically triggered at low to medium biomass levels ranging between 20% and 50% of virgin stock size (B_0) (Figure 8.4.2.11). All simulations of the CPUE reference points highlighted they can falsely trigger at large biomasses (Figure 8.4.2.11). The management performance of the 70% and 80% CPUE reference points often accurately triggered at low biomasses around 20% B_0 (Table 8.4.2.6). For example, the 70% moderate one-way management strategy only correctly triggered for 88% of the biomasses that were below 20% B_0 . Lower accuracy resulted from using the 60% CPUE reference point. The accuracies were quite low if CPUE reference points were used to manage biomasses around B_{MSY} (Table 8.4.2.6).

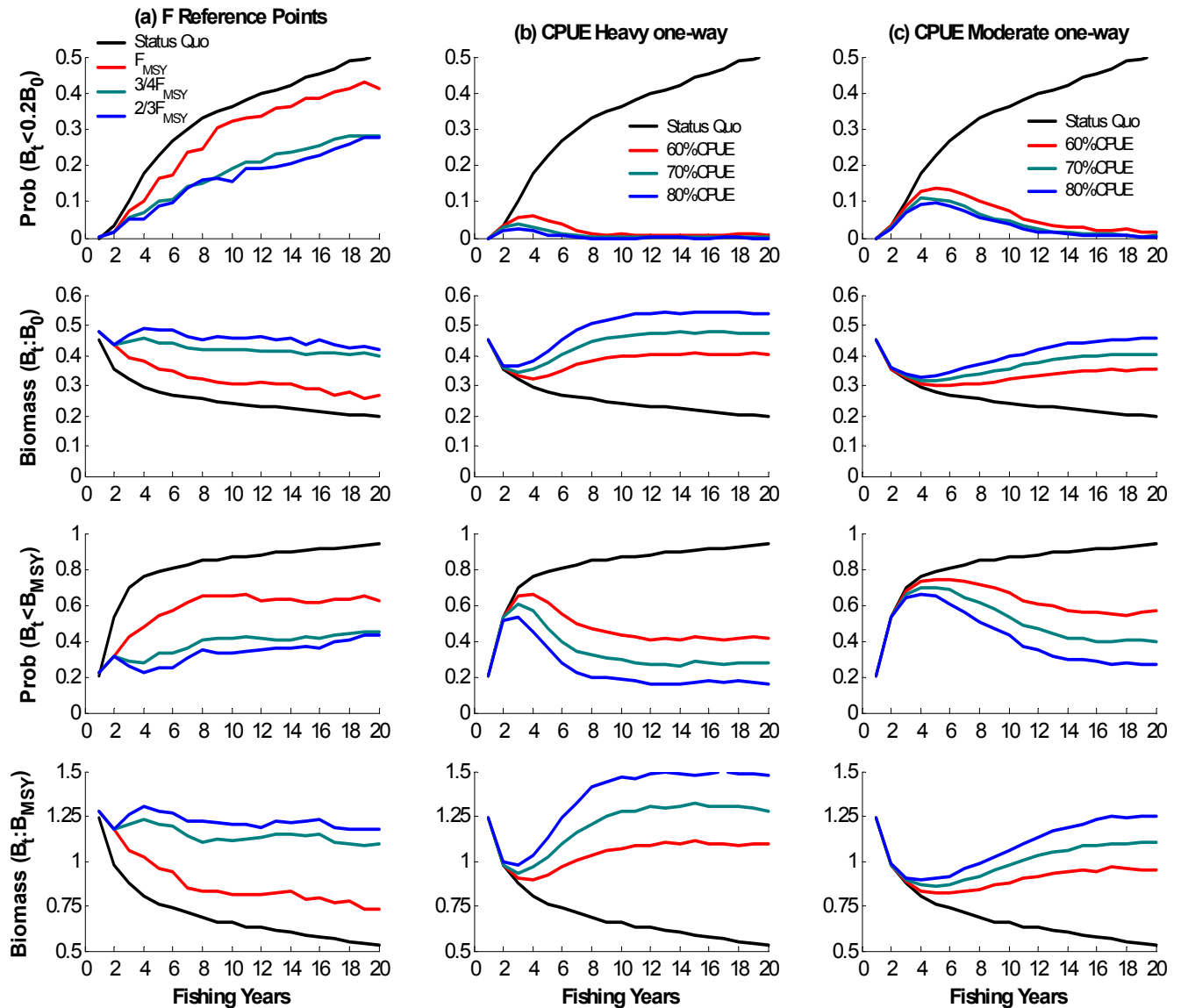

Figure 8.4.2.8 The expected biological outcomes for Torres Strait tiger prawns from managing fishing effort according to, (a) fishing mortality, (b) heavy one-way catch-rate, and (c) moderate one-way catch rate reference points. The first two rows of plots illustrate the outcomes in relation to virgin population size (B_0). Outcomes on the bottom two rows were measured against the population size which supports maximum sustainable yield (B_{MSY}). Lower probabilities (or risks) of the population sizes falling below $0.2B_0$ were for fishing efforts managed at 80% heavy one-way catch-rates. Similar probabilities of the population sizes falling below B_{MSY} were calculated for fishing efforts managed at 3/4 and 2/3 of MSY effort, and 80% and 70% moderate one-way catch-rate reference points. Probabilities at 0.5 represent the population sizes at $0.2B_0$ and B_{MSY} (equal to one) respectively. The one-way and two-way catch-rate management strategies performed alike. The results assume Ricker recruitment and median fishing power increases; status quo represents about 10 000 days of fishing effort (12 500 fishing power standardised) with no management changes.

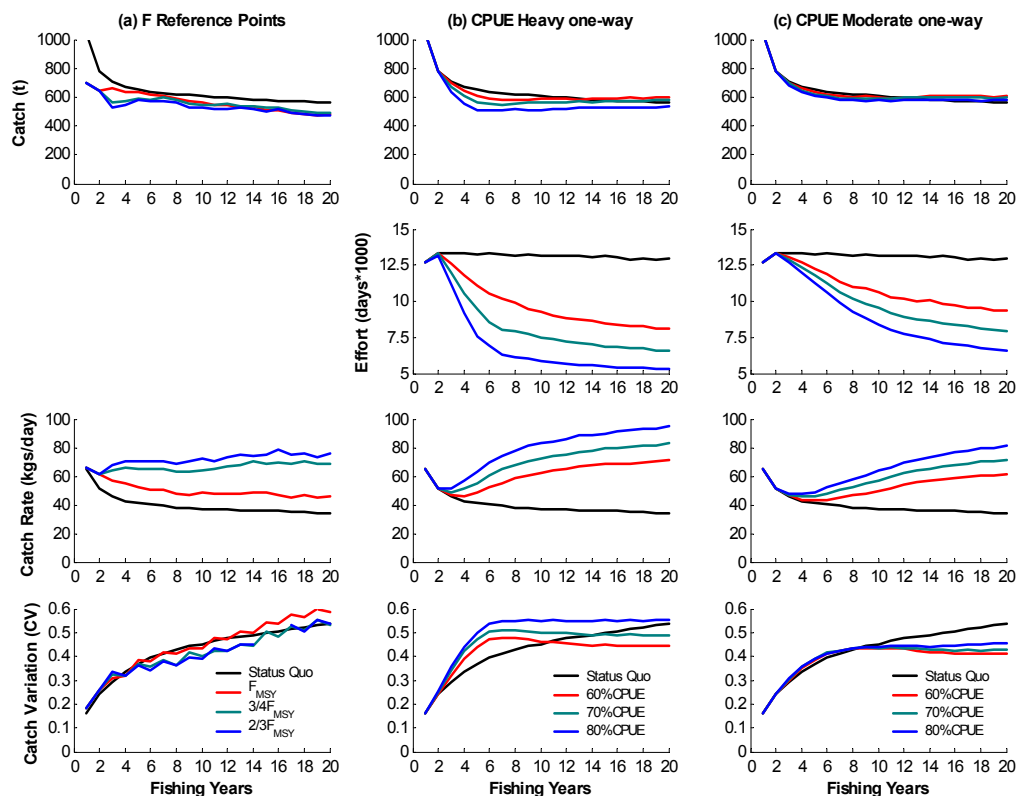

Figure 8.4.2.9 The expected industry outcomes from fishing Torres Strait tiger prawns and managing fishing effort according to, (a) fishing mortality, (b) heavy one-way catch-rate, and (c) moderate one-way catch-rate reference points. Industry outcomes were measured against median total catches, fishing effort, catch-rates and variation in total catch (coefficient of variation). All management strategies resulted in similar totals and variations in catches. However, the management strategies of 3/4 and 2/3 of MSY fishing effort, and the 70% and 80% heavy one-way catch-rate reference points produced higher catch-rates in the long term. The one-way and two-way catch-rate management strategies performed alike. The results assume Ricker recruitment and median fishing power increases; status quo represents 10 000 days of fishing effort (12 500 fishing power standardised) with no management changes.

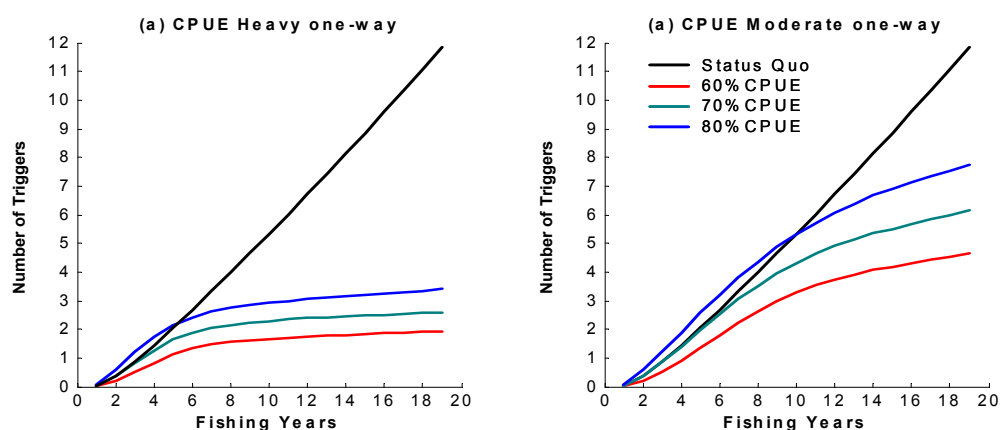

Figure 8.4.2.10 The average cumulative number of management changes (limit catch-rate triggers) for the (a) heavy one-way catch-rate, and (b) moderate one-way catch-rate reference points. Generally over twenty years, between two and three catch-rate triggers will occur under the heavy one-way management strategy, but up to five or eight may occur under moderate one-way management strategy. Again, the one-way and two-way catch-rate management strategies performed alike. The results assume Ricker recruitment; status quo represents the number of catch rates falling below 70% CPUE for 10 000 days of fishing effort (12 500 standardised) with no management changes.

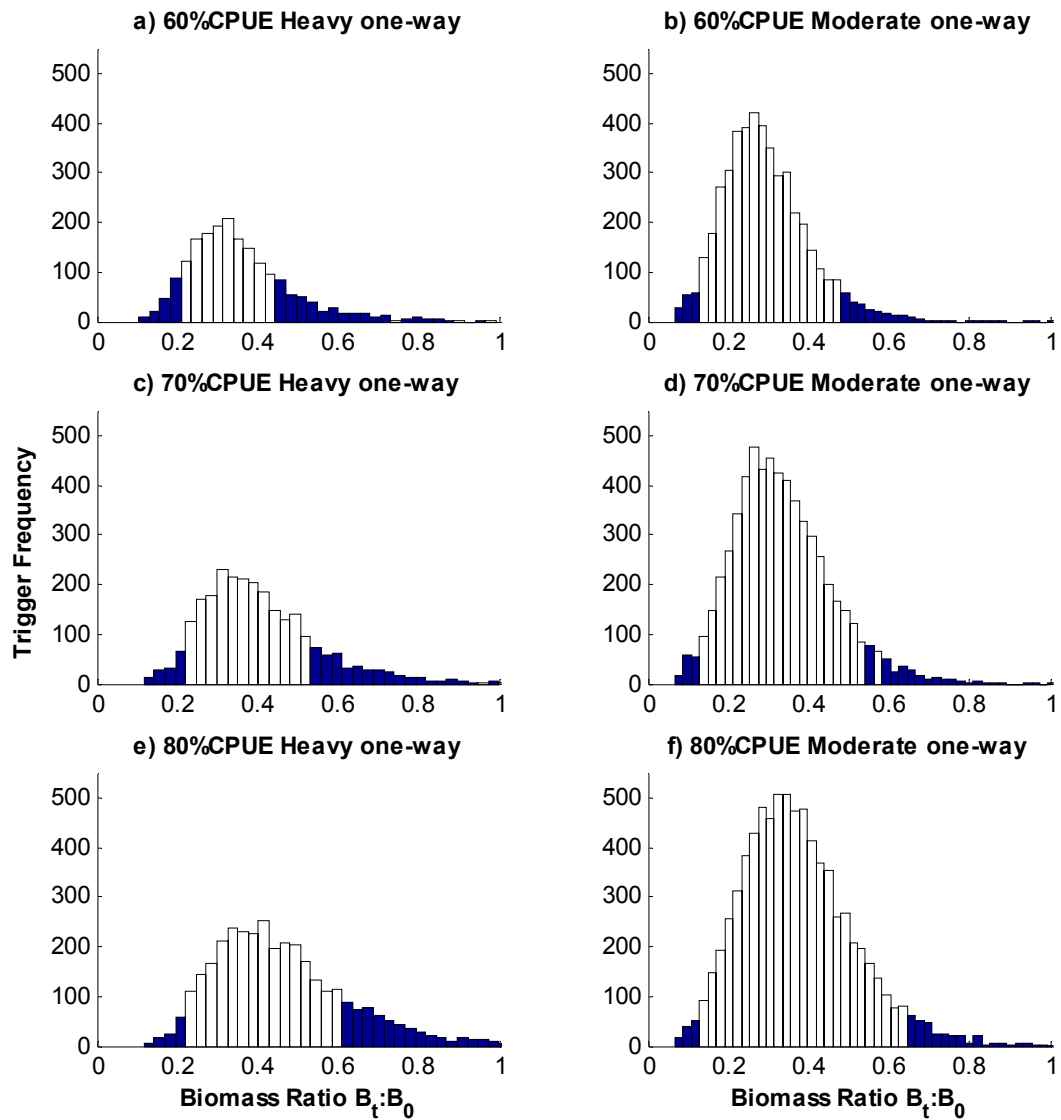

Figure 8.4.2.11 Distribution of the exploitable biomasses, expressed as a ratio of virgin biomasses, at which the catch-rate reference points triggered. The results are shown from the monthly delay difference model for 10 000 test-fishing days of effort (12 500 standardised), assuming Ricker recruitment. The catch-rate reference points triggered more frequently under the moderate one-way management strategy and trigger at marginally lower population sizes due to the slow response of this management strategy to alter fishing effort.

Table 8.4.2.6 The accuracy of catch-rate reference points measured from the monthly delay difference for 10 000 test-fishing days of effort (12 500 standardised), assuming Ricker recruitment. The higher probabilities for the 80% CPUE and moderate one-way management strategy indicate better accuracy measured against the biomass reference levels of $0.2B_0$ and B_{MSY} (e.g. 0.94 is 94% accurate).

Reference Point	Management Strategy	Proportion of Triggers Accurately detecting when $B_t < 0.2B_0$	Proportion of Triggers Accurately detecting when $B_t < B_{MSY}$	Actual Biomass (B_t/B_0) at Trigger		
				5th percentile	Median	95th percentile
60% CPUE	Heavy one-way	0.34	0.10	0.19	0.33	0.63
60% CPUE	Moderate one-way	0.72	0.26	0.14	0.28	0.48
70% CPUE	Heavy one-way	0.50	0.14	0.22	0.38	0.70
70% CPUE	Moderate one-way	0.88	0.34	0.16	0.32	0.55
80% CPUE	Heavy one-way	0.63	0.19	0.24	0.43	0.78
80% CPUE	Moderate one-way	0.94	0.43	0.18	0.36	0.62

8.4.3 Saucer Scallops

Catch Statistics

Saucer scallop harvest varied greatly between 1989 and 1996 (Figure 8.4.3.1). Total catch from these fishing years averaged 962 t meat, with the smallest catch of 397 t taken in 1989 and the largest catch of 1738 t taken in 1993. After the 1996 fishing year total catches averaged 791 t meat, with catches ranging between 623 t and 1045 t. Fishing efforts applied to saucer scallops between 1990 and 2001 were relatively consistent, averaging 13 583 nights with a range of 9729 and 16 772 nights. Fishing effort for the 2002 fishing year was significantly less at 7436 nights. Average monthly standardised-catch-rates show a downward trend between 1989 and 2002, but were stable from 1998 (Figure 8.4.3.2). Monthly standardised-catch-rates peaked at an average of 21 baskets for the 1993 fishing-year between November 1992 and April 1993. Standardised-catch-rates averaged only six baskets for the 1996 and 1997 fishing years. Since 1998 standardised-catch-rates average about eight baskets. Note the spike in the February 2001 catch rate of 15.5 baskets and the January 2002 catch rate of 18.6 baskets. This corresponded to the rotational opening of the spatial closures. Caution should be applied calculating annual catch rates for 2001 and 2002, as they would be biased upwards due to the rotational closure effects (Jebreen et al. 2003).

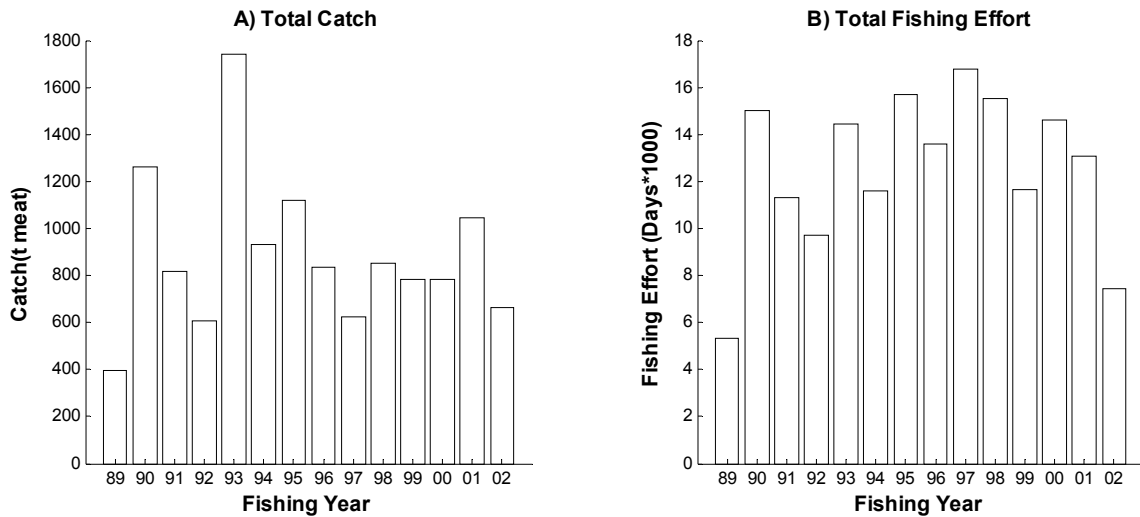

Figure 8.4.3.1 The saucer scallop total catch and fishing effort reported from 1989 to the 2002 fishing-year. The statistics represent all catches south of 22.5 degrees.

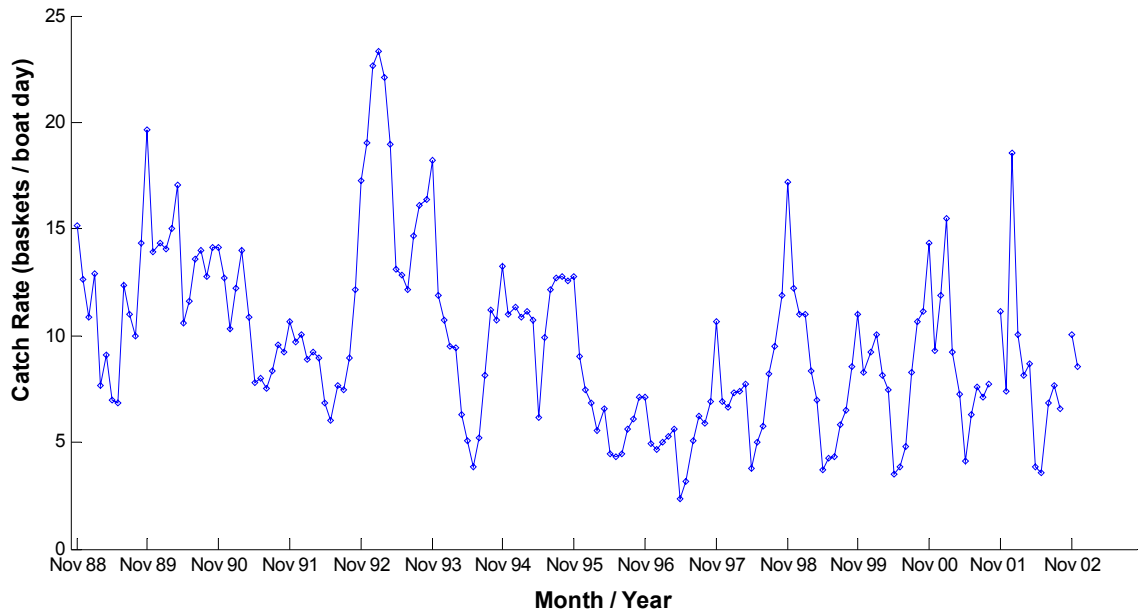

Figure 8.4.3.2 Monthly standardised saucer scallop catch rates from 1989 to 2002; note the seasonal patterns in catch rates and the overall gradual decline. The gaps in catch rates relate to the October seasonal closure. The February 2001 catch rate of 15.5 baskets and the January 2002 catch rate of 18.6 baskets relate to the rotational opening of the spatial closures.

Biological Data and Management

Table 8.4.3.1 contains a summary of the biological parameters used to calculate average rates of scallop growth and natural mortality, weight, size at maturity, fecundity and monthly variation in spawning activity. These biological parameters are deterministic and the model sensitivities to the parameters are reported as part of the stock assessment. These parameters are based on previous research studies and were assumed to most accurately reflect the true biological parameters for the scallop

population. As such, they were treated as the base-case against which the model sensitivities were measured.

The growth curve was based on a weighted average of the parameters reported by (Williams and Dredge 1981). The weightings were based on the number of recaptured tagged scallops from a series of tag-recapture experiments. The model considered the management-imposed seasonal variations in minimum legal size and also the slight differences between the regulated shell height measures (90 mm and 95 mm) and those applied by fishers, which equate to about a 2 mm reduction in the actual size of scallops that can be retained (Figure 8.4.3.3). The incidence of scallops with mature and spent gonads were used to indicate relative spawning activity (Dredge 1981). Generally, the relative amount of spawning was greater between April and August (Figure 8.4.3.3). This study also found that 75% of scallops were mature at a shell height of greater than or equal to 90 mm. Logistic regression on these data, using the mid-points of the size categories, approximated maturity across the ages (Figure 8.4.3.3). No significant exponential relationship existed between shell height and fecundity ((Dredge 1981); Figure 8.4.3.3). These reproductive fecundity data were combined with the population estimates from the stock assessment model to calculate spawning stock sizes. The scallop meat-weight relationship was based on data collected from October in 2000 and 2002. Although the relationship was adjusted each month for changes in meat-weight condition (Table 8.4.3.1), it did not take account of soaking procedures that are sometimes used by processors to increase meat-weight by 5–10%.

To enable a more complete analysis of the stock assessment and reference points, historical changes in management were included. Management of the saucer scallop fishery through three spatial closures commenced in April 1989 following concerns about the sustainability of the fishery. These closures were implemented for seven months between April and October 1989 and were assumed to have negligible effect on the assessment as they were removed after ‘industry had shown unwillingness to comply with these closures’ (Queensland-Fish-Management-Authority 1989). As a result of declines in catch rates in 1996/1997, the closures were reintroduced in February 1997. The closures were generally referred to as ‘scallop replenishment areas’ and were fixed in place until 2001, where management, as a result from industry pressure, began a rotational strategy of opening and closing the areas to trawling (Figure 8.4.3.4). Fishery independent estimates of scallop numbers in the closures were included to account for the closure effect on the exploitable proportion of the stock (Figure 8.4.3.4; (Jebreen et al. 2003)). The minimum legal sizes of scallops have also varied historically. From 1988 to December 1999 minimum legal sizes were set at 90 mm from November to April and 95 mm for May to October inclusive. In January 2001 sizes changed to 90 mm from January to April, and 95 mm for May to December, inclusive.

Table 8.4.3.1 Saucer scallop parameters used as biological inputs into the monthly age-structured model; standard errors in parentheses.

Parameters	Estimates	Data Sources
Von Bertalanffy Prawn Growth $L_{\infty} k$	106.026 SH mm; 0.225 month ⁻¹	Weighted average; (Williams and Dredge 1981)
Shell Height (SH mm) to Weight $w_{grams} = aSH^b$		
$a_{total_weight}, b_{total_weigh}$	2.39E-05, 3.221	FRDC2000/170, 2003
$a_{meat_weight}, b_{meat_weight}$	1.26E-09, 3.485	LTMP, QFS, 2003
Commercial Measure (CM) to Shell Height $SH = a + bCM$		FRDC2000/170, 2003
a, b	-0.4516 (0.0928), 0.9789 (0.001)	
Relative Meat Weight Condition (Proportional relative to October)		Dredge (unpublished)
January	1.17	
February	1.25	
March	1.17	
April	1.08	
May	1.00	
June	0.83	
July	0.83	
August	0.83	
September	0.92	
October	1.00	
November	1.08	
December	1.17	
Natural Mortality (M)	0.09	(Dredge 1985a)
Shell Height (mm) to Fecundity $f_{eggs} = aSH^b$		
a, b	3220.708 (24558), 1.354 (1.665)	(Dredge 1981)
Proportion (p) mature at age a, b	-0.794 (0.238), 0.178(0.022)	(Dredge 1981)
Where $\eta = a + bAge$, and $p = \frac{e^{\eta}}{1 + e^{\eta}}$		
Monthly Spawning Pattern (Proportion, β)		
November	0.0072	(Dredge 1981)
December	0.0000	
January	0.0144	
February	0.0288	
March	0.0899	
April	0.1331	
May	0.1403	
June	0.1439	
July	0.1439	
August	0.1403	
September	0.0863	
October	0.0719	

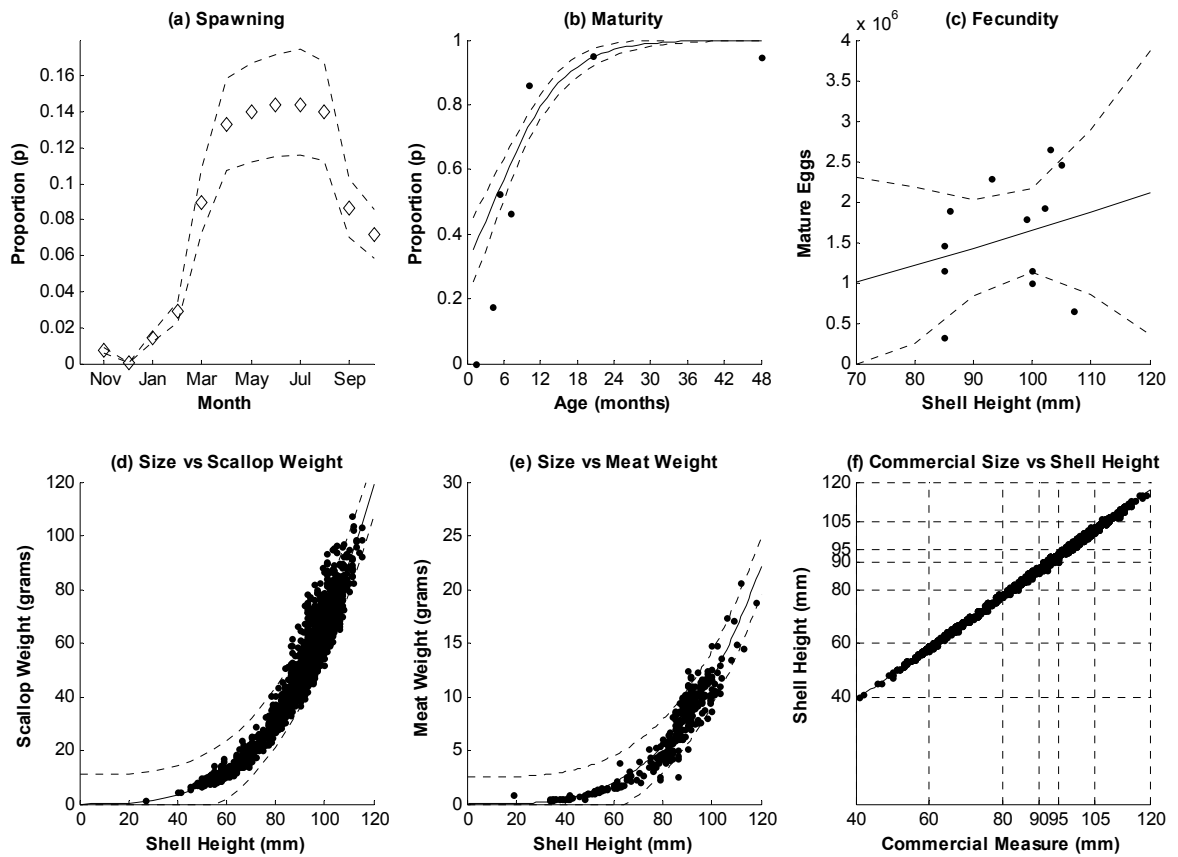

Figure 8.4.3.3 Biological research on saucer scallops in 1981 showed that (a) spawning mostly occurred between April and August, (b) most scallops older than about eight months (90 mm shell height) were mature, and (c) fecundity was weakly related to size. More recently, data obtained from FRDC Project 2000/170 were used to quantify average (d) scallop total weights, (e) scallop meat weights, and (f) commercial size grading. 95% confidence intervals represented by dotted lines on figures (b) to (e); figure (a) dotted lines represent two times the 10% standard error. See Table 8.4.3.1 for data sources.

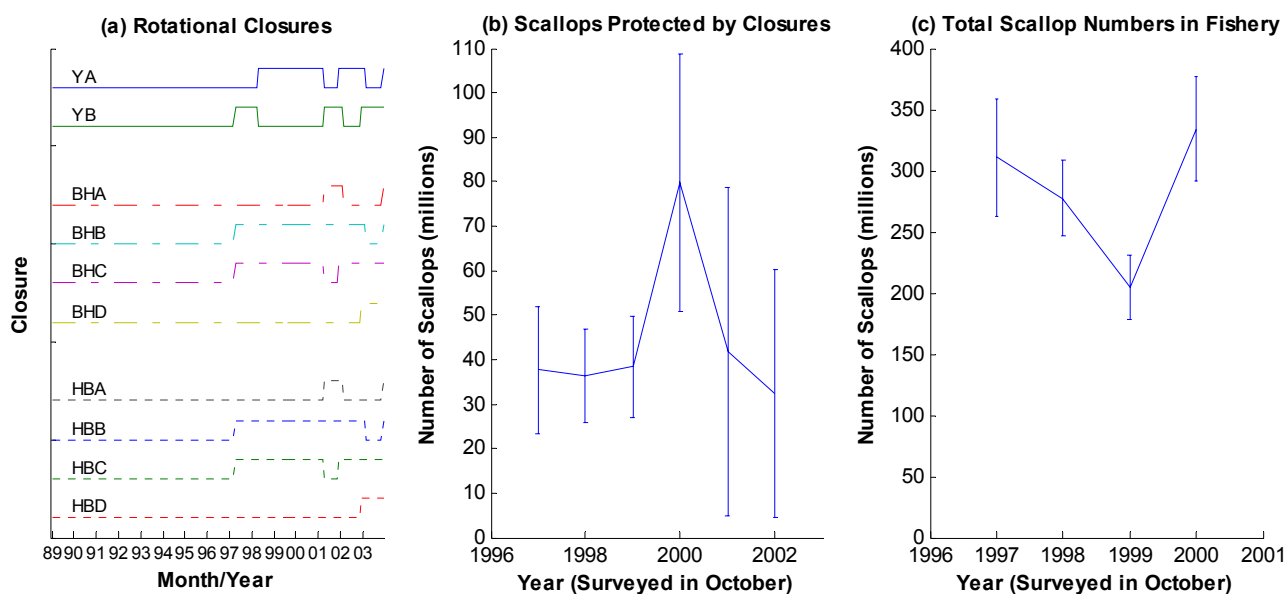

Figure 8.4.3.4 (a) Application of fixed spatial closures in the scallop fishery commenced in 1997 and changed to a rotational closure strategy in 2001. (b) Fishery independent surveys showed that the number of scallops protected by the closures increased in 2000, but decreased in 2001 and 2002. (c) Fishery independent surveys of scallops across the entire fishery only occurred between 1997 and 2000, with a peak estimate in 2000. The raised lines on (a) represent closure periods. Yeppoon (YA and YB), Bustard Head (BHA, BHB, BHC and BHD), and Hervey Bay (HBA, HBB, HBC and HBD). Vertical lines in (b) and (c) are 95% confidence intervals.

Stock Assessment

The saucer scallop stock assessment used two modelling approaches – a monthly age-structured model and an annual Schaefer surplus production model (Figure 8.4.3.5, Figure 8.4.3.6 and Figure 8.4.3.7). The age-structured model compared three monthly rates of natural mortality (M) and three levels of annual increase in fishing power, with their respective 90% confidence intervals (Figure 8.4.3.5 and Figure 8.4.3.6). These plots were structured accordingly:

- Figure 8.4.3.5A resulted from assuming $M = 0.09 \text{ month}^{-1}$, which, based on the literature, is likely to be the most accurate estimate of natural mortality (Table 8.4.3.1) and from incorporating the median estimate for annual fishing power increase. The model was considered to most accurately reflect reality and was therefore used as the base-case.
- Figure 8.4.3.5B resulted from assuming a lower rate of natural mortality ($M = 0.07 \text{ month}^{-1}$) equal to the 2.5th percentile on a normal distribution with mean 0.09 and standard deviation of 0.01.
- Figure 8.4.3.5C assumed a relatively high rate of natural mortality ($M = 0.11$) equal to the upper 97.5 percentile on a normal distribution with mean 0.09 and standard deviation of 0.01.
- Figure 8.4.3.6A resulted from assuming no annual increase in fishing power (i.e., no annual effort creep) in the assessment or the stock-recruitment relationship. Figure 8.4.3.6A and B also assumed natural mortality at $M = 0.09 \text{ month}^{-1}$. The effect of changing fishing power should be compared against Figure 8.4.3.5A (i.e. median annual fishing power increases).
- Figure 8.4.3.6B resulted from incorporating relatively higher levels of annual increase in fishing power. The annual increases were the upper 90% confidence

interval of the annual increases in fishing power, which varied between years. These estimates of the increase in fishing power were incorporated in both the assessment and the spawner-recruitment relationship.

Note the purpose of comparing different outputs was to highlight the influence of estimates natural mortality (M) and fishing power. In general, the annual increases in fishing power had little effect because the estimated increases in the scallop trawl sector were minimal (see Chapter 6).

The age-structured model generally predicted that biomass, expressed as a ratio to virgin exploitable stock biomass size, declined between 1989 and 1997 (Figure 8.4.3.5 and Figure 8.4.3.6). The biomass was notably below B_{MSY} in the 1997 fishing-year and this reflected the low catch rates reported at that time. Since 1998, the predicted biomasses varied around B_{MSY} for all scenarios. In comparison to these results, the Schaefer surplus production analysis also predicted declining biomasses between 1989 and 1997 (Figure 8.4.3.7). The biomasses from 1994 to 1999 were judged to be below B_{MSY} (represented at $\frac{1}{2}$ virgin-stock size in the Schaefer model (Haddon 2001)). The biomass in 2001 increased and was above B_{MSY} . The confidence intervals on the model estimates were quite large.

The monthly age-structured model and Beverton-Holt spawner-recruitment curve (Figure 8.4.3.8) were used to estimate the equilibrium virgin stock size (B_0) and the population size that supports maximum sustainable yield (B_{MSY}) (Table 8.4.3.2). The yield estimates and the steepness of the Beverton-Holt curve were very similar to those derived from the Ricker spawner-recruitment relationship. Details on the catch data used in the spawner-recruitment curves are shown in Table 8.4.3.3. Only about 5% of all daily catch records were from 1978 to 1987. However, in order of 700 to 1 000 days of fishing were still recorded in each year from 1978 to 1981.

Estimates of equilibrium management quantities across four different minimum legal sizes show that MSY was similar, but lower assuming Ricker recruitment compared with Beverton-Holt (Table 8.4.3.4). E_{MSY} estimates were lower for the less conservative 90 mm size limit compared with the larger size limit of 95 mm. Additional sensitivity analysis on the age-structured model showed that higher E_{MSY} was related to higher rates of natural mortality and for no annual increases in fishing power increases. Conversely, lower E_{MSY} was calculated for higher fishing power increases (Table 8.4.3.5). Management quantities from the surplus-production model are provided in

Table 8.4.3.6. The estimate for the model's population-growth parameter (r) was high at 1.2. Values above 1 generally indicate that the stock has high intrinsic rate of increase, and as a result higher levels of E_{MSY} were calculated.

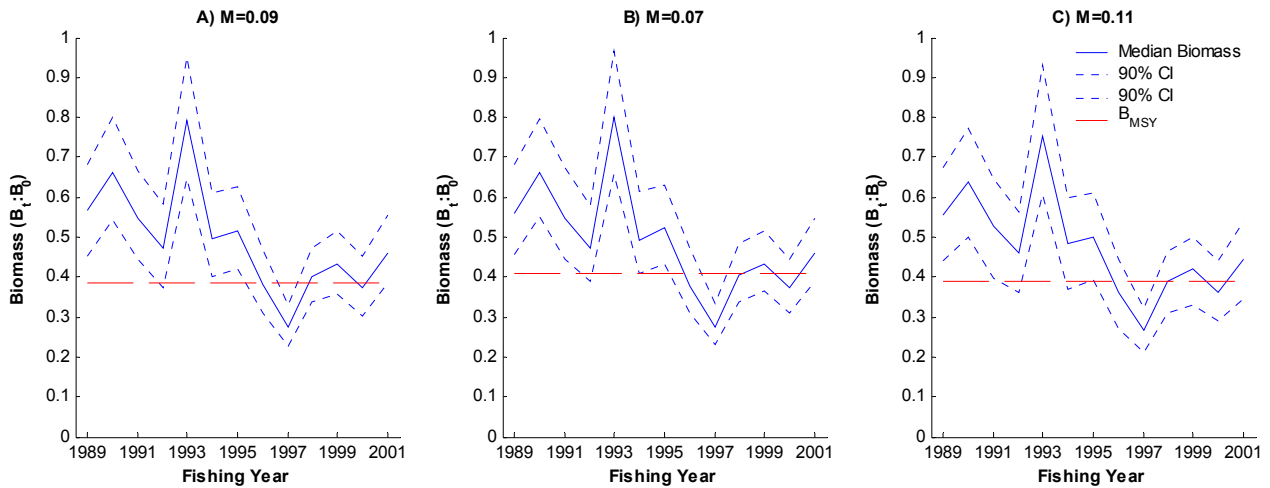

Figure 8.4.3.5 The monthly age-structured model predicted declining exploitable biomasses for scallops between 1989 and 1997. Since 1997, biomasses varied around the biomass reference point for maximum sustainable yield (B_{MSY} the dashed red horizontal line). Results are presented for three estimates of natural mortality (M) and the model assumed the median annual estimate of increasing fishing power. B_{MSY} was calculated using the Beverton-Holt spawner-recruitment curve (Figure 8.4.3.8). The dotted lines represent the 90th percentiles.

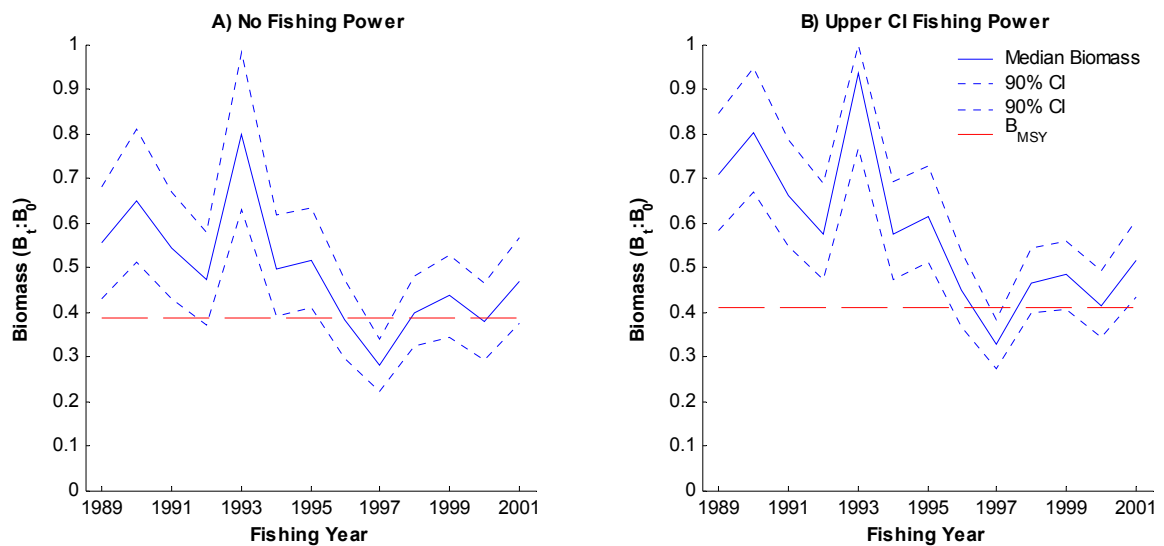

Figure 8.4.3.6 Biomass estimates from the monthly age-structured model for two different estimates of the annual increase in fishing power. The model incorporated a single estimate of natural mortality ($M = 0.09$). Trends in the exploitable biomass were similar to those in Figure 8.4.3.5A.

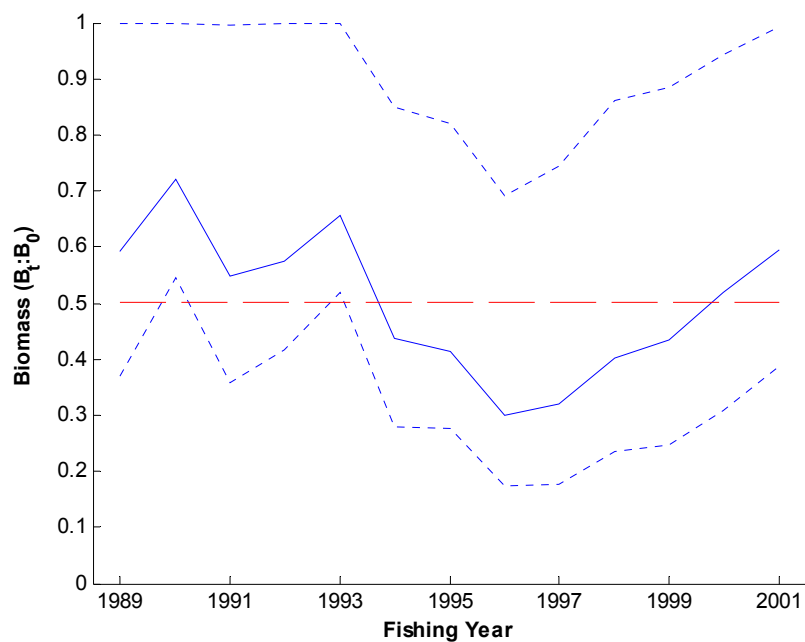

Figure 8.4.3.7 The annual surplus production model predicted declining exploitable biomasses for the scallop fishery between 1989 and 1997 fishing years (dotted lines represent the 90th percentiles). The model predicted increasing biomass since 1997. The dashed red horizontal line shows the biomass reference point for maximum sustainable yield (B_{MSY}).

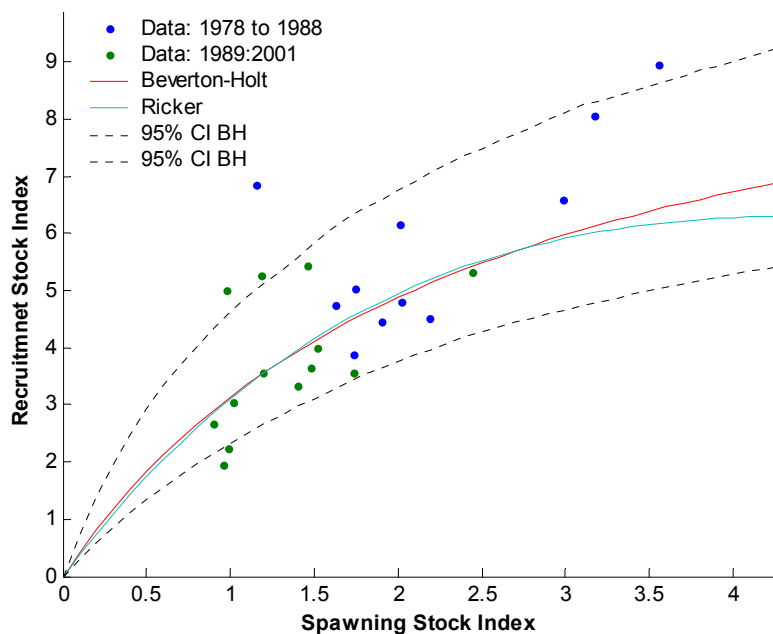

Figure 8.4.3.8 Scallop spawner-recruitment relationships assuming the Beverton-Holt form (red line) and the Ricker form (green line). The curves were fitted using a weighted log-likelihood and incorporate the median estimates of annual increases in fishing power. Two-year autocorrelations were non-significant at -0.235 .

Table 8.4.3.2 Saucer scallop spawner-recruitment parameters. Numbers within parentheses refer to the parameter standard error and T statistic for α and β , and 90% confidence intervals for steepness.

Spawner-Recruitment Parameters	Beverton-Holt	Ricker
α	226 500.826 (62 651.237; 3.62)	3.902e-6 (6.312e-7; 6.18)
β	9.185e-10 (4.657e-10; 1.97)	2.274e-15 (1.108e-15; 2.05)
Steepness	0.32 (0.23:0.52)	0.30 (0.22:0.4)

Table 8.4.3.3 The number of daily catch records and weightings used to construct the spawner-recruitment curves. The vast majority of data (95%) were obtained from the compulsory logbook program that commenced in 1988.

Fishing Year	Recruitment Index (Nov to Feb)	Spawning Index (May to Aug)	Other Months	Total Records	Total Records (Recruitment + Spawning)	Weighting For Likelihood
1978	449	270	475	1194	719	0.006
1979	355	692	224	1271	1047	0.009
1980	449	320	465	1234	769	0.007
1981	241	662	94	997	903	0.008
1982	49	75	116	240	124	0.001
1983	80	78	103	261	158	0.001
1984	55	48	70	173	103	0.001
1985	47	16	54	117	63	0.001
1986	53	66	307	426	119	0.001
1987	178	297	1460	1935	475	0.004
1988	2653	257	2827	5737	2910	0.026
1989	1675	1388	2053	5116	3063	0.027
1990	4058	1574	5591	11 223	5632	0.050
1991	4577	5362	3886	13 825	9939	0.088
1992	4070	2826	3120	10 016	6896	0.061
1993	5043	2524	5173	12 740	7567	0.067
1994	5228	4225	4402	13 855	9453	0.084
1995	4881	1959	6688	13 528	6840	0.060
1996	7461	4097	4206	15 764	11 58	0.102
1997	5770	1922	6897	14 589	7692	0.068
1998	7396	4079	4781	16 256	11 475	0.101
1999	4917	3353	4744	13 014	8270	0.073
2000	6444	1971	4550	12 965	8415	0.074
2001	5313	3605	2325	11 243	8918	0.079
Total	71 442	41 666	64 611	177 719	113 108	1.000

Table 8.4.3.4 Scallop equilibrium management quantities as calculated from the monthly age-structured model using two forms of the spawner-recruitment relationship and median annual increases in fishing power. The quantities were calculated for four different minimum legal shell-sizes. *Note comment in paragraph two under the biological data and management section. Numbers in parenthesis are 90% confidence intervals.

Management Quantities	Beverton-Holt	Ricker
Current Size Limit – Jan-Apr		
90 mm, May–Dec 95 mm		
MSY (millions of shell)	50 (10:150)	44 (5:130)
MSY (tonnes meat)*	658 (131:1923)	599 (69:1714)
E _{MSY} (2001 nights)	11 709 (4681:32 385)	9437 (3366:20 805)
3/4 E _{MSY} (2001 nights)	8782 (3511:24 289)	7078 (2524:15 604)
2/3 E _{MSY} (2001 nights)	7806 (3121:21 590)	6292 (2244:13 870)
Size Limit – 90mm all year		
MSY (millions of shell)	50 (10:152)	45 (5:132)
MSY (tonnes meat)*	650 (129:1895)	590 (68:1679)
E _{MSY} (2001 nights)	10 934 (4422:29 699)	8853 (3190:18 790)
3/4 E _{MSY} (2001 nights)	8201 (3316:22 274)	6640 (2393:14 093)
2/3 E _{MSY} (2001 nights)	7289 (2948:19 799)	5902 (2127:12 527)
Size Limit – 95mm all year		
MSY (millions of shell)	49 (9:149)	44 (5:130)
MSY (tonnes meat)*	666 (132:1948)	605 (70:1731)
E _{MSY} (2001 nights)	12 287 (4852:35 668)	9821 (3432:22 476)
3/4 E _{MSY} (2001 nights)	9215 (3639:26 751)	7366 (2574:16 857)
2/3 E _{MSY} (2001 nights)	8192 (3235:23 780)	6547 (2288:14 985)
Size Limit – Nov-Apr 90mm, May-Oct 95mm		
MSY (millions of shell)	50 (10:150)	44 (5:131)
MSY (tonnes meat)*	653 (130:1910)	592 (68:1695)
E _{MSY} (2001 nights)	11 254 (4551:31 182)	9123 (3273:19 571)
3/4 E _{MSY} (2001 nights)	8441 (3413:23 387)	6842 (2455:14 678)
2/3 E _{MSY} (2001 nights)	7503 (3034:20 789)	6082 (2182:13 048)

Table 8.4.3.5 Additional management calculations, from the scallop age-structured model, based on varying the monthly rate of natural mortality (M) and fishing power increases. These results relate to the current minimum legal size of 90 mm Jan–Apr, and 95 mm May–Dec, assuming Beverton-Holt recruitment.

Management Quantities	M = 0.07, Median estimates of annual increase in Fishing Power	M = 0.11, Median estimates of annual increase in Fishing Power	M = 0.09, No annual increase in Fishing Power	M = 0.09, Annual increase in Fishing Power = upper 90% CI
MSY (millions of shell)	47	52	50	46
MSY (tonnes meat)*	639	671	661	600
E _{MSY}	8053	12 386	13 670	9886
3/4E _{MSY}	6040	9289	10 273	7415
2/3E _{MSY}	5369	8257	9131	6591

Table 8.4.3.6 Summary of the parameters estimated from the Schaefer surplus production model.

Parameter	Estimate (90% Confidence Interval)
Population Growth Rate r	1.203 (0.548:1.728)
Management Quantity	
MSY (tonnes meat)*	1149 (941:1217)
E_{MSY}	15 251 (11 289:19 199)
$3/4 E_{MSY}$	11438 (8467:14399)
$2/3 E_{MSY}$	10168 (7526:12800)

For both the age-structured and surplus production model stock assessments there was no evidence to suggest the models were inadequate for the data or that the use of lognormal errors were inappropriate. Figure 8.4.3.9 shows that the models predicted the standardised catch rates quite well, although the monthly age-structured model did slightly underestimate three of the monthly peak catch rates present in the time series. The standardised residuals for these large catch rates were all less than four, indicating they were not extreme. The influence of these data points had little effect on the log-likelihood or upon the estimation of the parameters. For example, removing or slightly increasing their effect resulted in little change in the parameter estimates, suggesting the model captured these observations reasonably well and that it accurately modelled the year-to-year and month-to-month patterns of saucer scallop catch rates. The surplus production fit to the annual time series tended to over estimate standardised catch rates from 1990 to 1992, to compensate for the large catch rates in 1993. Although, from 1993 the model generally captured the trend in catch rates.

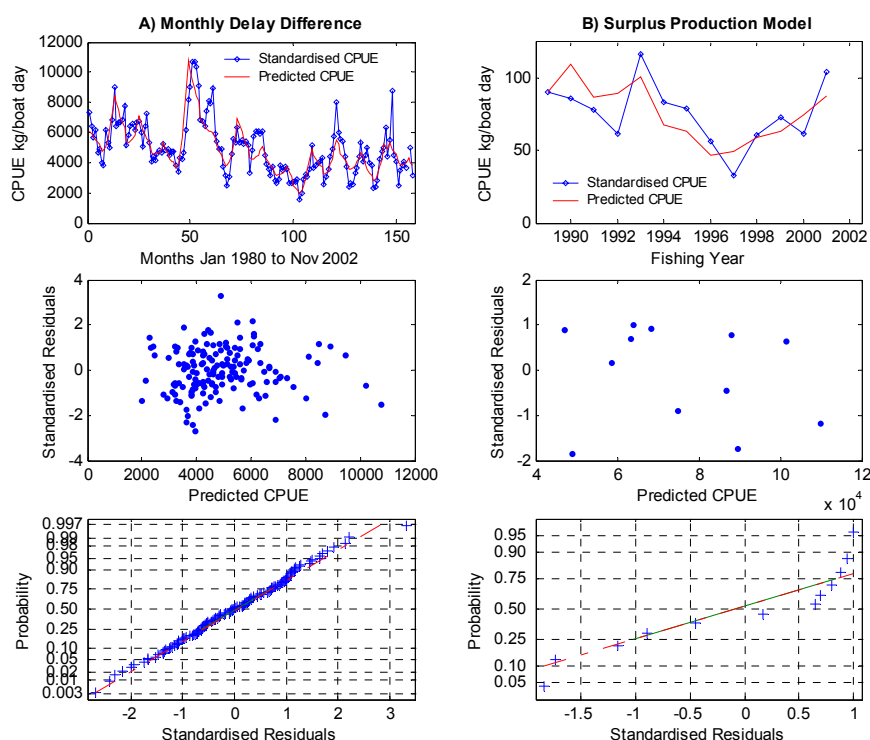

Figure 8.4.3.9 The monthly age-structured (left side) and Schaefer surplus production (right side) models predicted the standardised catch-rates well (1st row plots). The use of lognormal errors was appropriate with no pattern in standardised residuals (2nd row plots) and linear normality plots (3rd row plots).

Reference Point Simulations

The reference points examined by the two models are provided in Table 8.3.10.1. A large number of results were generated from these simulations, mainly as a result of the various stock-recruitment possibilities and the range of minimum legal size regulations. The results presented in this section focus on the performance of reference points through the monthly age-structured model using the Beverton-Holt spawner-recruitment relationship (which assumes median annual increases in fishing power) and the current seasonally changing size limits (i.e. the base-case) (Figure 8.4.3.5A). Results from all simulations, including these, are tabulated in Appendix 15.1 and summarise forecasts for five-year and 20-year periods. Definitions used to interpret the simulations are listed under the Methods section 8.3.10, page 101. The simulations assess the consequences of using different reference points and management strategies and the subsequent results are presented to allow the reader to evaluate the trade offs in performance. The results do not define a final reference point, management strategy or the future status of the scallop fishery, but rather they provide expected outcomes that may be used by decision makers to help select appropriate reference points to achieve the management objectives. It is important to note that the management objectives for the scallop fishery are yet to be defined.

Biological Performance

The model simulations suggested that higher biomass trajectories would be attained using the 80% CPUE reference point, under the heavy one-way management intervention (Figure 8.4.3.10). After 20 years, these biomass trajectories levelled at above $1.5B_{MSY}$ or $0.6-0.7 B_0$. The $2/3 F_{MSY}$, $3/4 F_{MSY}$, and other CPUE reference points, also resulted in relative increases in biomass and the 20-year biomass trajectories levelled at $1.25-1.5 B_{MSY}$ or $0.5-0.6 B_0$. Retaining the status quo (13 000 fishing nights), or adopting F_{MSY} as a reference point generally resulted in relatively lower biomass trajectories that fall below B_{MSY} after 20 years.

The probability trajectories for the biomass falling below 20% of the virgin stock biomass (B_0) and B_{MSY} were lowest under the CPUE reference points using a heavy one-way management strategy. Conversely, the probability of the biomass falling below 20% B_0 was highest with status quo fishing effort and when the F_{MSY} reference point was used. When the probability of $B_t < B_{MSY}$ equals 0.5, then the biomass approaches B_{MSY} .

All the $2/3 F_{MSY}$, $3/4 F_{MSY}$, and CPUE reference points and management strategies ensured the biomass was above B_{MSY} with greater than 60% confidence. The F_{MSY} and status quo strategies failed this.

Industry Performance

The simulations indicate that status quo fishing would likely lead to the best scallop catches for industry (Figure 8.4.3.11). Fishing according to the $3/4 F_{MSY}$ and $2/3 F_{MSY}$ reference points also produced similar catches after about ten years. Although, a drop in catch would likely result from the lower fishing effort applied in the first five to ten years. The CPUE reference points all resulted in lower catch trajectories after 10 to 20 years, but the 80% CPUE under the heavy one-way management scenario resulted in the highest trajectories for catch rate and the lowest trajectories for fishing effort.

Status quo fishing and the F_{MSY} reference point resulted in higher fishing effort and the lowest catch rates. The variations in total catches (CV) were smallest for the $3/4F_{MSY}$ and $2/3F_{MSY}$ fishing strategies. Overall, the catch-rate reference points, with annual management responses, appear to reduce fishing effort effectively even though the biomass trajectories are above $0.5B_0$ or $1.25B_{MSY}$ (Figure 8.4.3.10).

Management performance

The number of triggered CPUE reference points was higher for the 80% CPUE reference point and lower for the 60% CPUE reference point (Figure 8.4.3.12). In other words, the higher the CPUE reference point the more likely it was to trigger. The CPUE reference points resulted in three to eight corrections in fishing effort, over the 20-year forecast, depending on the response mechanism (moderate or heavy) and the reference point (60%, 70% or 80% CPUE). Generally, the $3/4$ and $2/3 F_{MSY}$ reference points resulted in one significant correction in fishing effort (Figure 8.4.3.11).

The CPUE reference points triggered at a wide range of biomasses, but typically ranged between 30% and 60% of virgin stock size (B_0) (Figure 8.4.3.13). All simulations of the CPUE reference points highlighted they can falsely trigger at large biomasses. The management performance of the 70% and 80% CPUE reference points often accurately triggered at low biomasses around 20% B_0 (Table 8.4.3.7). For example, the 70% moderate one-way management strategy only correctly triggered for 70% of the biomasses that were below 20% B_0 . Lower accuracy resulted from using the 60% CPUE reference point. The accuracies were again lower if CPUE reference points were used to manage biomasses falling below B_{MSY} (Table 8.4.3.7).

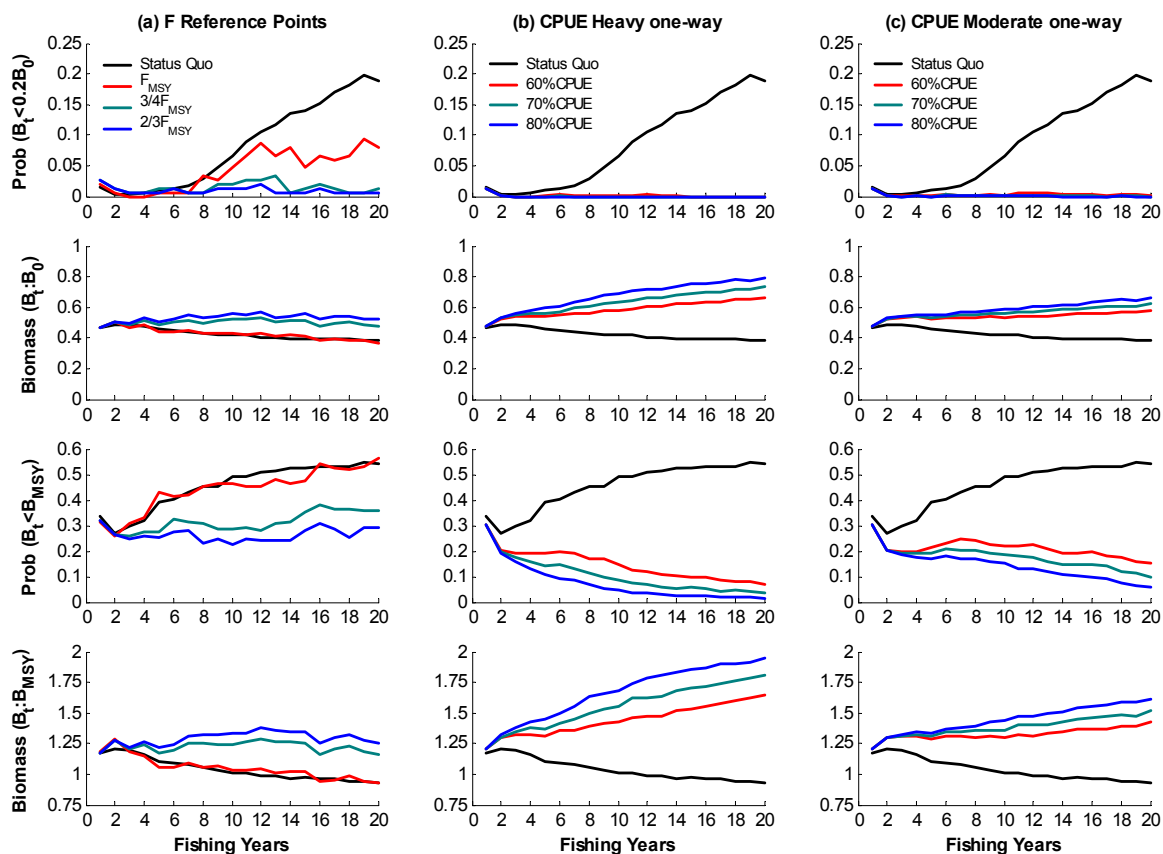

Figure 8.4.3.10 The expected biological outcomes for saucer scallops from managing fishing effort according to, (a) fishing mortality rates, (b) heavy one-way catch-rate, and (c) moderate one-way catch rate reference points. The first two rows of plots illustrate the outcomes in relation to virgin population size (B_0). Outcomes on the bottom two rows were measured against the population size, which supports maximum sustainable yield (B_{MSY}). Low probabilities (or risks) of the biomass falling below $0.2B_0$ were obtained for the 60–80% CPUE reference points, and for the $3/4 F_{MSY}$ and $2/3 F_{MSY}$ reference points. Similar results were obtained in relation to the biomass falling below B_{MSY} when effort was managed using the 60–80% CPUE reference points. The B_{MSY} probabilities at 0.5 represent the population sizes at B_{MSY} . The one-way and two-way catch rate management strategies performed alike. The results assume Beverton-Holt recruitment and median estimates of the annual increase in fishing power. Simulations for status quo and the fishing mortality reference points commenced at 13 000 nights of fishing effort. Simulations for the CPUE reference points commenced at 10 000 nights of fishing.

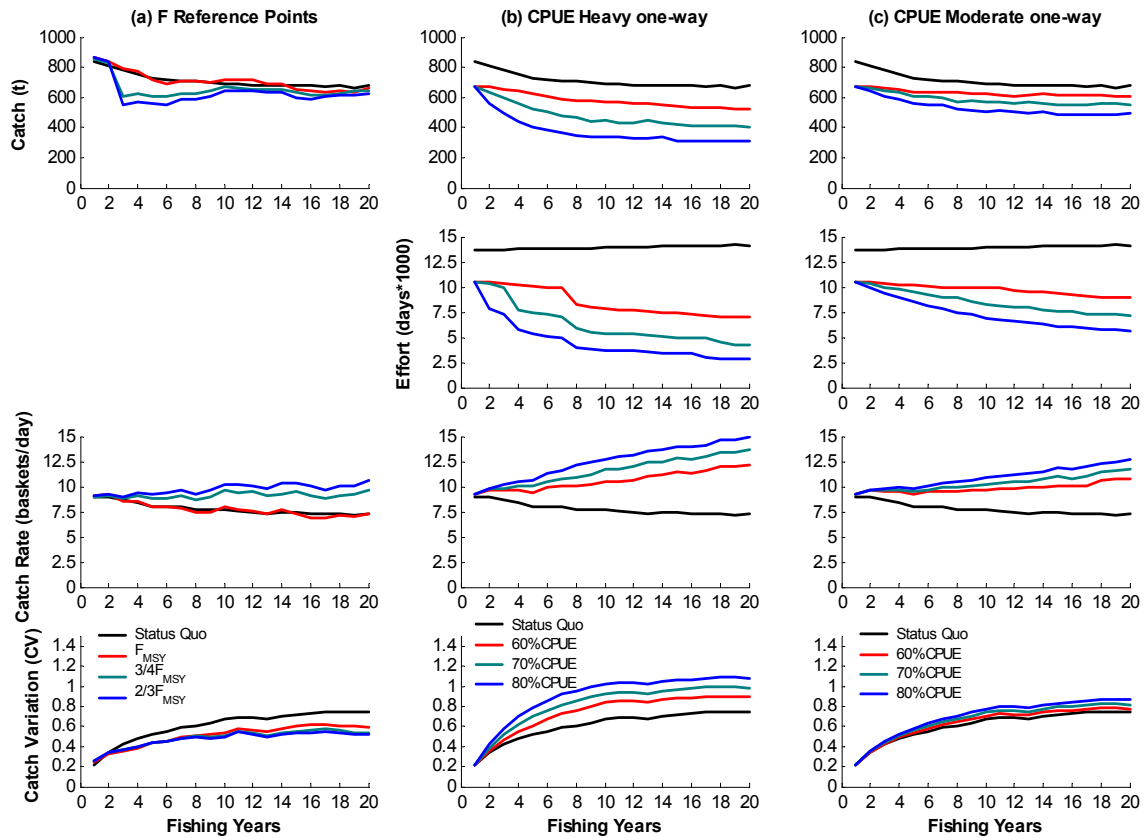

Figure 8.4.3.11 The expected industry outcomes from forecasting fishing effort in the scallop fishery according to, (a) fishing mortality, (b) heavy one-way catch-rate, and (c) moderate one-way catch-rate reference points. Industry outcomes were measured against total catches, fishing effort, catch-rates and variation in total catch (coefficient of variation). The management strategies of 3/4 MSY and 2/3 of MSY fishing effort resulted in equivalent long-term total catches and lower catch variations than retaining the status quo. However, the heavy one-way catch-rate reference points produced higher catch-rates in the long term. The one-way and two-way catch-rate management strategies performed alike. The forecasts assumed Beverton-Holt recruitment and the median annual increases in fishing power. Simulations for status quo and the fishing mortality reference points started at 13 000 nights of fishing effort. Simulations for the CPUE reference points commenced at 10 000 nights of fishing.

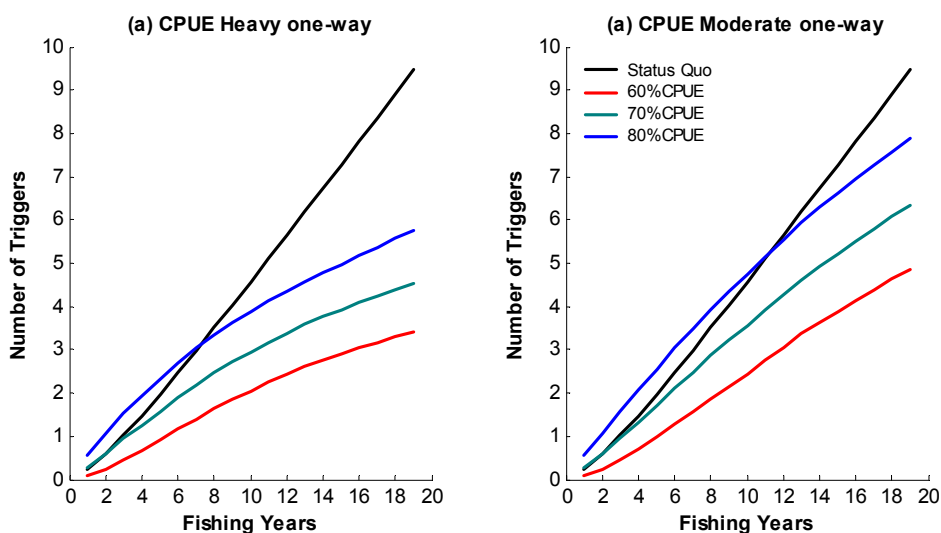

Figure 8.4.3.12 The average cumulative number of management changes (limit catch-rate triggers) for the (a) heavy one-way catch-rate, and (b) moderate one-way catch-rate reference points. Generally over twenty years, between three and six catch-rate triggers will occur under the heavy one-way management strategy, but up to six or eight may occur under the moderate one-way management strategy. Again, the one-way and two-way catch-rate management strategies performed alike. The results assume Beverton-Holt recruitment and median fishing power increases. Simulations for status quo commenced at 13 000 nights of fishing effort and represents the number of catch rates falling below 70% CPUE. Simulations for the CPUE reference points commenced at 10 000 nights of fishing.

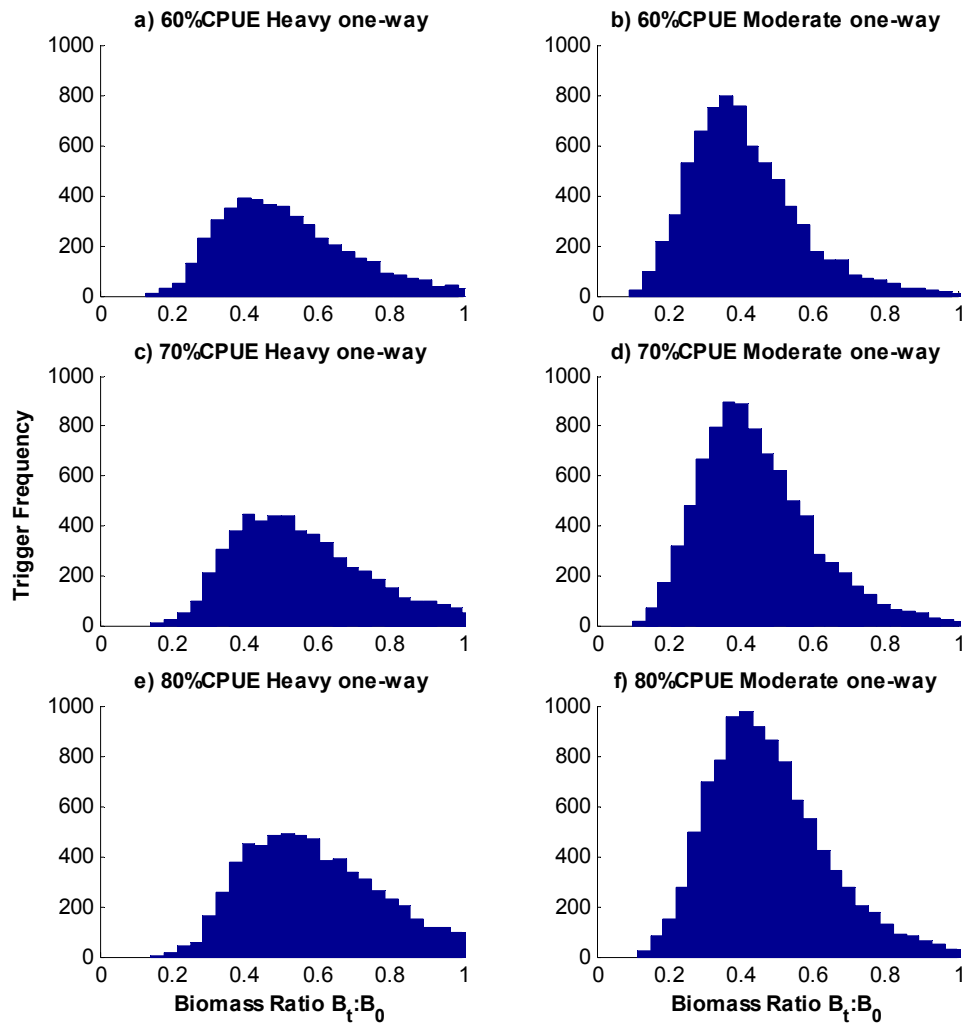

Figure 8.4.3.13 Distribution of the exploitable biomasses, expressed as a ratio of virgin biomasses, at which the catch-rate reference points triggered. The results are shown from the monthly age-structured model for 15 000 test-fishing days of effort, assuming Beverton-Holt recruitment. The catch-rate reference points triggered more frequently under the moderate one-way management strategy and trigger at marginally lower population sizes due to the slow response of this management strategy to change fishing effort.

Table 8.4.3.7 The accuracy of six catch-rate reference points measured from the monthly age-structured model for 15 000 test-fishing days of effort. The higher probabilities for the 80% CPUE and moderate one-way management strategy indicate better accuracy measured against the biomass reference levels of $0.2B_0$ and B_{MSY} .

Reference Point	Management Strategy	Proportion of Triggers Accurately detected when	Proportion of Triggers Accurately detected when	Actual Biomass (B_t/B_0) at Trigger		
		$B_t < 0.2B_0$	$B_t < B_{MSY}$	5%ile	Median	95%ile
60% CPUE	Heavy one-way	0.46	0.24	0.27	0.49	0.84
60% CPUE	Moderate one-way	0.64	0.39	0.20	0.39	0.70
70% CPUE	Heavy one-way	0.60	0.33	0.30	0.53	0.89
70% CPUE	Moderate one-way	0.70	0.50	0.23	0.42	0.74
80% CPUE	Heavy one-way	0.80	0.47	0.33	0.56	0.90
80% CPUE	Moderate one-way	0.83	0.62	0.25	0.46	0.77

8.5 DISCUSSION

8.5.1 Reference Points

The comparison of data-based (catch-rates) and model-based reference points has provided a basis for Queensland, New South Wales, and AFMA trawl managers, and their relevant committees to consider sustainable levels of fishing effort, reference points and their response mechanisms. The reference points and management responses considered here are only small subsets of the full range of possibilities. The results quantified the trade-offs of various management in relation to reference points, and will help set target management objectives for fishing eastern king prawns, Torres Strait tiger prawns and saucer scallops. The results do not define a final reference point, management strategy or the future status of the stocks, but rather they provide expected outcomes that may be used by decision makers to help select appropriate reference points to achieve the target objectives. The relevance of this work to management is very high, especially since the management objectives for trawling will continue to be revised. The current objectives in all three trawl-sectors do not define any reference points, together with management responses, that could be used to restrict fishing effort to levels that are sustainable. This research is timely and provides a starting point for discussion of potential reference points, management strategies and objectives. Fishery management advisory committees and working groups should participate fully to discuss and develop the strategies, and time lines to achieve the management objectives. These strategies should be assessed by the management strategy evaluation method. The continuation of this work is required for these trawl sectors to achieve optimal management.

The results across the trawl sectors suggest that for biomasses at B_{MSY} or below, the $2/3E_{MSY}$ target fishing effort tended to ensure future biomasses would increase above B_{MSY} with greater than 50% confidence over 20 years. Adopting the $2/3E_{MSY}$ over 20 years would also result in total catches not being reduced, catch rates would increase, the variation in total catches would be minimised and that only one major change to fishing effort would occur. Alternatively if biomasses were above B_{MSY} , fishing effort at $3/4E_{MSY}$ would also achieve the expected outcomes above. It should be noted that any stock assessment is prone to uncertainties and error. For this reason,

target fishing at E_{MSY} has high risk and performs poorly in relation to outcomes for sustainability, industry and management.

The simulations also show that catch-rate reference points can restrict fishing effort to levels that are sustainable, but cannot accurately manage these prawn and scallop trawl-sectors. The catch-rates can trigger at high population sizes, resulting in inappropriate changes in fishing effort. Similarly, low population sizes may not necessarily trigger the reference point. These results occurred primarily due to the observed variation in catch rates and uncertainty in measuring prawn or scallop catchability (q). Even after standardising the catch rates for changes in fishing power, it does not appear that catch-rate reference points are precise enough to correctly warrant a change in fishing effort. The simulations do assume that catch rates are proportional to abundance; however, for a given population size catch rates can still vary 20–30%. In addition, many different factors can affect commercial catch rates, and even if it was possible to allow for these factors the catch rate reference points are not fully predictable with abundance. When selecting an appropriate catch rate to use as a trigger point there is a trade-off between ensuring accurate detection of low biomasses with reduction of inappropriate triggering at high biomass levels.

A better approach to management than to modify effort using the current 70% CPUE limit reference points would be to target fishing at about $2/3E_{MSY}$ or $3/4E_{MSY}$ with revisions for increases in fishing power and new assessments. These fishing mortality reference points ($2/3E_{MSY}$ or $3/4E_{MSY}$) appear more effective at maintaining the stocks safely above B_{MSY} , but not exceedingly, resulting in lower risks of under or overfishing, improved yields and catch rates at lower fishing effort. The stock assessments are prone to uncertainties and error, but changes in fishing effort are likely to result from more justified reasons and eliminate any catch rate reference point triggers that can occur by chance. The catch rate reference points will work to ensure the effort is sustainable, but not necessarily to ensure the stocks are at B_{MSY} . As a consequence long-term reduced yields may result. The results do conflict with the suggested alternative to model based reference points – that is, that data-based approaches should be preferred (Hilborn 2002). But the role of catch rates as reference points is still unclear. Observation of linear trends in recruitment and spawner CPUE, such is done for setting the Queensland spanner crab total allowable catch, may be a more robust practice in conjunction with stock assessments every two years. Additional simulations, and clear management target objectives, are required to examine this linear regression of catch rates and other strategies in more detail. Management also need to decide whether they want frequent (greater than five times in 20 years) or infrequent (less than three times in 20 years) intervention benefits of $2/3E_{MSY}$.

All simulations show that the continuation of status quo levels of fishing effort will introduce long-term risks of overfishing in the three trawl sectors examined. Future alternate levels of fishing will depend on the target objectives for each trawl sector. When detailed management targets have been defined, simulations using these targets, as mathematical objective functions will help define clearer sustainable fishing effort. For example, (Francis 1993) defined an objective function to maximise average catch, and searched for a management option subject to the condition that the probability $P(B_t < 0.2B_0) < 0.1$ (Francis and Shotton 1997). Another example is the target objective defined for Australia's Northern Prawn Fishery. It was defined as 'In

determining milestones and performance measures for the fishery, NORMAC agreed that from 2002 and thereafter (annually) NORMAC will use the NPFAG accepted assessment model to estimate the performance of the previous year's stock relative to spawner target levels. The agreed target is a 70+% chance that the spawner population at the end of 2006 will be above or at spawner target levels. NORMAC will utilise the advice of the NPFAG (majority) to provide the advice to assess performance against the target. If the agreed target is not projected to be reached, NORMAC will recommend appropriate effort adjustment measures for implementation in 2004' (NORMAC 2001). The target spawner level was S_{MSY} , which is related to B_{MSY} . This target example is probably more appropriate than the first, given that MSY is now considered more to be a limit reference point (Garcia and Staples 2000). Many multiple objective functions could be defined and for example could combine the two above to cover both limit and target reference points. Irrespective of future management objectives for the prawn and scallop sectors, all simulations here show that with reduced levels of fishing, higher biomasses, higher catch rates, and equivalent status quo annual catches will result. The perception by many people that more nights of fishing effort equals more total catches does not hold true in the long-term. However, for a single vessel total catch is maximised by the number of nights fished, but not catch rates. Note that the results were highly dependent on the shape and magnitude of the spawner-recruitment relationship. Additional simulations assuming alternative spawner-recruitment relationships to those highlighted in the results section 8.4, are provided in the Appendices. Generally, these results refer to higher steepness in the spawner-recruitment curve, and therefore lower risks associated with higher fishing effort. The dependency of the spawner-recruitment relationship is discussed more in the next section 8.5.2, especially in relation to the effects of different fishing power increases. Tracking future changes in fishing power is an essential ongoing requirement for these fishing-effort (input controlled) managed fisheries.

Uncertainty still clouds the ideal reference fishing point for the eastern king prawn, Torres Strait tiger prawn and saucer scallop trawl sectors. This problem remains for most fisheries, as reference points depend on our knowing how many fish are in the ocean (Hilborn 2002). New types of data are essential to improve the accuracy of stock assessments, such as spatial indices of abundance collected through fishery independent sampling and VMS. More accurate and robust reference points may exist using these data. These pieces of information will aid in refining the stock assessment, interpretation of results, defining reference points and strengthen future management decisions.

8.5.2 Stock Assessment and Future Development

The stock assessments presented are the most comprehensive attempt to evaluate the status of eastern king prawns, Torres Strait tiger prawns and saucer scallops. The assessments were based on monthly time steps and captured the seasonal patterns in fishing effort and catches. The models brought together the biological relationships on prawn and scallop growth rates, natural mortality and spawning. They also included estimates of annual increases in fishing power, historical catch rates prior to the compulsory logbook system implemented in 1988, and spawner-recruitment relationships. In addition, the outcomes from these monthly models were compared alongside the more simplistic annual surplus production models. It should be noted

that the eastern king prawn and saucer scallop assessments were based on a time series of 13 years and a degree of uncertainty in relation to the estimated spawner-recruitment relationships remain. These spawner-recruitment relationships are key inputs to determine the status of these fisheries. They require regular updated analysis and should be discussed in detail by researchers, managers and industry. It was highlighted in the review of the 2001 assessment of tiger prawns in the Northern Prawn Fishery, that with 30 years of catch and effort data, the fishery was still only considered to have limited/moderate data (Deriso 2001).

Eastern King Prawns

The results for eastern king prawns indicate the 2001 biomass was at about B_{MSY} . Biomasses prior to 2001 were calculated to be below B_{MSY} . The stable biomass trends between 1989 and 1997 were similar to those calculated in 1998, but they were not scaled to virgin stock size (B_0) (Dichmont et al. 1999). The spawner-recruitment relationships were used to define the status of the eastern king prawns in relation to virgin stock sizes (B_0) and the biomasses (B_{MSY}) that support maximum sustainable yields. Sensitivities of assuming different spawner-recruitment relationships were reported utilising the historical pre-1988 and post-1987 catch rates and assuming three different rates of annual increases in fishing power; confirming past comments that there appears to be some decline in recruitment of eastern king prawns to the offshore ocean fishery (Williams 2002). The results across the sensitivity analyses suggested current levels of fishing effort are probably too high to promote higher biomasses in the future. However, the results are uncertain and dependent on the historical pre-1988 assumptions on fishing power increases, and that the standardised catch rates from November to February and May to August are linearly related to recruitment and spawning biomasses, respectively. It is unlikely that the assumed historical fishing power increases were constant through time at the 1989 to 1999 rate of increase, but were likely to vary over the entire history of the recorded catch rates.

Historical changes in the management of prawns in Queensland appear to have had little effect on catch rates of eastern king prawns. Research surveys conducted in 1982–83 and 1983–84 identified new deep water fishing grounds in southern and central Queensland (Potter and Dredge 1985). Coinciding with these findings the net head rope length increased in size significantly for the offshore deep waters. Whilst at the time the authors were cautious in promoting the newly discovered fishery as economically viable, the changes in management suggest that interest from a number of fishers probably led to the introduction of the new regulations regarding net sizes. Also worthy of note is the primary motivation for the exploratory study:

‘... If new grounds and resources were discovered, then some fishing effort might be diverted from the adjacent continental shelf trawl fisheries ... there is a general belief that the east coast prawn fishery is overcapitalised with too many vessels working on the established grounds.’ (Potter and Dredge 1985).

The above statement seems to be reflected in the declining standardised catch rates used in the spawner-recruitment relationships. Post-1988 catch rates are dramatically lower compared to pre-1988. This contrast was even evident in the unstandardised catch rates spawner-recruitment indices. It seems that the eastern king prawn sector

experienced increased fishing effort during the 1970–80s. Since 1989, catch rates have remained relatively constant.

The results as they stand provide the first credible hypothesis on the state of eastern king prawns. We are certain that these results and others in the future will need to be discussed in detail, as they should, but most probably to defend against the notion that the burden of proof lies with those who would claim it is safe to keep fishing at current effort levels, or higher (Walters and Martell 2002). The stock assessment still needs further work:

1. Fishing power and catch rate standardisation is of very high importance for eastern king prawns. Fishing gear and technology information on the pre-1988 vessels, which recorded catch rates, are needed. The data will reduce the uncertainty in the spawner-recruitment relationship and more clearly define the status of the stock. A more elegant method for including the pre-1988 catch rates into the assessment would be preferred, but is difficult given the lack of data on total catch or total fishing effort.
2. Spatially separate monthly standardised-catch-rates may improve accuracies of E_{MSY} estimates. This will take into account the spatial distribution of fishing, but may be difficult to develop given the uncertain spatial accuracy of the monthly catch reporting of eastern king prawns in New South Wales.
3. Fishery-independent eastern king prawn recruitment surveys on the offshore fishing grounds should be of high importance to improve estimates of prawn abundance (Courtney et al. 2002), and would also help with on-going catch-rate standardisation (i.e. monitoring fishing power increases). The importance of having a catch rate index that is linearly related to abundance cannot be over-emphasised. This can be improved by including survey estimates (Punt 2001).
4. Significant uncertainty remains regarding the status of eastern king prawn stocks in the first year of the assessment (1989). Historic data on total landings should be acquired (from industry/processors?) from 1978 to 1988. These data should be used to develop priors for starting stock biomass ratios.
5. It is recommended that landings estimates obtained with logbook data are validated. Historical commercial unloading data is probably available, at least for some vessels and could be used as a source of validation. If unloading data are obtained, even if it is only samples for some vessels, a generalised linear model can be run to validate the logbook catches determine the significance of correction factors for estimates of landings obtained from logbook data. Factors to be considered in the analysis could be month, year, area (may not be possible if vessels fish in more than one area during a single unloading period), and possibly type package used to pack prawns. The dependent variable should be the logbook catch for a vessel and the independent the unloading catch for the same vessel in the same period of time. If enough size-grade data is present in logbooks size grade could be also used as a factor.
6. Since aging of penaeid prawns is not possible at this time, size-graded prawn catches should be recorded, validated and used in the stock assessment (O'Neill et al. 1998).
7. Update, review and collaborate estimates of natural mortality M , especially in terms of M changing with prawn size, will improve accuracies of the calculated management related quantities (e.g. E_{MSY}).

8. Investigate the use of statistical priors on the spawner-recruitment steepness to improve accuracies of management related quantities (e.g. *Penaeus esculentus* and *P. semisulcatus* from (Dichmont et al. 2001; Ye 2000).
9. Seasonal closures to protect juvenile recruiting eastern king prawns should be investigated to increase spawning stock sizes.
10. Collaborative stock assessment and management should commence with Queensland and New South Wales, especially for setting target levels of fishing effort.

Torres Strait Tiger Prawns

The results for tiger prawns are timely and address the need to determine a level of fishing access that is sustainable and options for reduction of latent effort in the Torres Strait. Initially the Torres Strait had a very high level of latent effort that was reduced through reductions in the number of licences and allocation of fishing days to individual licences. The allocation of days was based on the highest effort recorded by individual vessels, which explains why the current cap (13 570 days of fishing) has never been reached. Effort in recent years has averaged about 10 200 days and the highest ever recorded was 11 907 days in 1991. The previous assessment by (Turnbull and Watson 1995), suggested that the maximum sustainable effort (E_{MSY}) was about 10 600 days using an assumed natural mortality rate of 0.2 per month. The authors also noted that due to the mobility of the fleet, fishing effort in Torres Strait was largely controlled by catch rates within Torres Strait and adjacent fisheries. They also noted that if in the future, fishing effort was 'locked into the fishery' then the current cap may need to be reviewed. Recent changes to management in adjacent fisheries are starting to restrict the ability of vessels to move freely between fisheries. In addition there are three licences reserved for use by Torres Strait Islanders and eight PNG endorsed vessels can fish in Australian waters under the current cross-board fishing arrangements. To date the islander and PNG cross-boarder entitlements have not been utilised but could be in the near future. Hence the need to determine a limit reference point for fishing effort that has a high probability of ensuring sustainable catch levels and accounts for the potential fishing effort of all sectors (Australian, Islander and PNG).

An assessment based on equilibrium and dynamic surplus production models was conducted during 2001–02 and presented to managers and industry for discussion. Industry was critical of the assessment including the 1980–89 logbook data and for focusing on the tiger prawn component of the catch. They considered that the early data was not representative of the fishery as it was only compulsory for the generally larger sized, NPF endorsed vessels to fill in logbooks. Industry also claimed that the fishery was largely an endeavour prawn fishery, especially in the southern section of Torres Strait. To address these concerns all available data were utilised to estimate changes in fishing power between 1980 and 2002. Four separate surplus production models using both the full (1980–2002) and restricted (1989–2002) time-series of catch and effort data were fitted (Figure 8.4.2.5). In addition associated endeavour prawn catch was included as a factor in the standardisation of catch rates to which the stock assessment models were fitted.

All data on Torres Strait vessels since 1980 were used to estimate changes in fishing power. The initial estimation of changes in fishing power in the Torres Strait prawn

fleet was only based on data for the years of full logbook records, 1989-2000. As the partial logbook data for the years 1980-88 represent the earlier stages of fishing, it was important to account for changes in fishing power during those years. In addition the pre-1988 data may represent the higher-fishing power subset of the fleet, as only NPF endorsed vessels were required to fill out logbooks. Some non-NPF endorsed vessels voluntarily filled in the NPF logbooks.

A variety of models were applied to the catch and effort data to compare estimates of the sustainable tiger prawn catch for the Torres Strait. Industry concerns that the early data may be biased were addressed by fitting some of the surplus production models to just the full logbook data (1989–2001). The estimates of MSY and E_{MSY} derived from the shorter time-series of data were similar to those from the full time-series.

The results from the Fox and Schaefer forms of the surplus production models and a monthly delay difference model based on a Ricker stock-recruitment relationship all suggest that from 1980 to 1994 tiger prawns stocks were fished down to the level estimated to produce the Maximum Sustainable Yield (B_{MSY}). Since 1994 the delay difference model suggested that stock size appears to have oscillated around B_{MSY} . Although the surplus production models also show an oscillation about B_{MSY} there was evidence of a continued decline suggesting a ‘one way trip’ effect when using annual catch rates in the assessment (Hilborn and Walters 1992).

The advantage of the delay difference model was that it utilised the large seasonal changes in catch and effort that provide good contrast to the time-series data. The yearly data used in the surplus production models lacked contrast. The problem with this type of data is that there is little information about management parameters such as optimum exploitation rate or MSY (Hilborn and Walters 1992). As a result the monthly delay difference model appeared to best reflect the dynamics of the data. As an example, the delay difference model indicated peak tiger prawn biomasses in 1992 and 1998 and lows in 1994 and 2000 that corresponded with highs and lows of commercial catch and catch rates. The model biomass estimates also match with recruitment indices from fishery independent surveys conducted during 1998–2002. The indices show a peak of recruitment in 1989 and a low in 2000. In contrast the biomass estimates of the surplus production models do not match as closely with the annual pattern of catch and effort (Figure 8.4.2.5).

All of the results indicate that the stock was harvested at MSY (~ 650t, CIs ~500 to 800t) and that any increase in fishing effort could reduce stock productivity. The MSY estimates were close to the Maximum Constant Yield for tiger prawn (682 t) estimated by (Turnbull and Watson 1995). Estimates of E_{MSY} were variable across the models, ranging from about 7200 to 14 500 nights (Table 8.4.2.2 to Table 8.4.2.5). The estimates of E_{MSY} were more variable as they are dependent on the estimate of catchability (q) for each optimal fit and assumption about the changes in fishing power over the time-series. The inherent variability in the estimation of E_{MSY} makes this model output imprecise. The management quantities estimated from the delay difference modelling were also highly dependent on the spawner-recruitment relationships, which were highly uncertain. To date the Torres Strait managers and industry have focused on using E_{MSY} as a starting point for discussions on reductions in fishing effort. A better approach may be to consider other alternatives such as

$3/4E_{MSY}$ or $2/3E_{MSY}$. Further development of the stock assessment through points one, three to eight, listed under the eastern king prawn assessment apply (page 161).

Saucer Scallops

The stock assessment results for saucer scallops are timely. Queensland scallop processors, scallop fishers and the fishery's managers have identified a strong need to evaluate the recent changes introduced in the Queensland East Coast Trawl Fishery. Prior to 2001, saucer scallop landings were valued at about \$30 million annually (Williams 2002). During 2002 and 2003 there was a significant drop (30–40%) in catch and fishing effort. In 2002 the Queensland Seafood Marketers' Association Inc. (QSMA) commissioned a report by Warwick Lee of the Queensland Fisheries Service to ascertain the status of marketers in the Tin Can Bay to Gladstone region (Lee 2002). The report (Lee 2002) confirmed a downturn in the profitability of the regional scallop processors. This has been accompanied by a decrease in the reported price paid to fishers, a 30% decline value to industry, seasonal reductions in processing staff numbers and days worked, and limited success from diversification strategies into other seafood species. Some processors have indicated that their business will be bankrupted as a result of the downturn. In March 2003, the Queensland Seafood Marketers' Association (QSMA) and the Queensland Seafood Industry Association (QSIA) called a special scallop management crisis meeting with DPI&F management and researchers to discuss the current state and nature of the trawl sector. A scallop working group was formed from this meeting. This working group has since called for the reduction in scallop minimum legal sizes to 90 mm all year and the abolition of the replenishment areas to improve catches and supplies of scallops to processors. This has created a strong need to determine the status of the saucer scallops and how management should be optimised to ensure the biological and economical sustainability of the fishery.

The biomass of saucer scallops was estimated at about B_{MSY} in 2001. In 1997, the biomass was notably below B_{MSY} , confirming the decline estimated in 1998 (Dichmont et al. 1999). The results also confirm the comments the resource is fully exploited (Williams 2002). Estimates of E_{MSY} from the age-structured model varied between one to two thousand nights less than the 13 000 nights fished in 2001. The estimates of E_{MSY} were at least one thousand nights less for the smaller 90 mm size limit, compared with the larger 95 mm size limit examined. The spawner-recruitment relationships were used to define the status of the saucer scallops in relation to virgin stock sizes (B_0) and the biomasses (B_{MSY}) that support maximum sustainable yields. Sensitivities of assuming different spawner-recruitment relationships were reported utilising the historical pre-1988 and post-1987 catch rates and assuming three different rates of fishing power increases. These results were sensitive to the shape of the spawner-recruitment curve, but not particularly sensitive to the estimates of annual increases in fishing power. It should be noted that management changes have potentially had an effect on the pre-1988 historical catch rates of scallops. Larger minimum shell size restrictions would have a negative effect on catch rates. However, from 1978 onwards fishers changed from primarily twin otter gear set ups to triple and quad nets. This change in configuration allowed fishing to be more safely conducted in areas with rougher bottoms and fast flowing tidal currents (Mike Dredge pers. comm. 2001). There is also anecdotal evidence that this change in configuration led to higher catch rates overall. In addition, increases in net length from 40 metres

(headrope) to 109 m (combined headrope and footrope) introduced in 1983 may have been expected to also increase catch rates. However, this is not evident from spawner-recruitment relationships, which show the catch rates spawner-recruitment indices general dropping. The increase in minimum shell size from 80 mm in 1981 to 85 mm in 1985 may have partially accounted for the reported declines. Similarly, the 1989 change to a seasonal minimum shell size of 95 mm from May to October, and 90 mm in the other months. However, the weighted log-likelihood used to fit the spawner-recruitment curves would partially allow for these significant effects of management changing catch rates.

There is still a strong need to determine how the trawl management changes including the allocation of trawl nights have affected the distribution of fishing effort, and how the management measures should be optimised to ensure the biological and economical sustainability of all the trawl sectors. To achieve this, economic data on the fishery are required. In addition, the assumed biological parameters on scallop natural mortality and growth need to be updated and corroborated. These parameters are currently based on tagging studies undertaken between 1976 and 1978, and may be biased as a result of non-tag-reporting issues (Dredge 1985a&b). Additional small tagging studies were carried out in 1993 and 1997 to estimate scallop growth, genetics and fishing mortality, but these data were not designed to estimate natural mortality (Dredge pers. comm. 2002). To further improve the current assessment the following is also needed:

- Additional fishing power and catch rate standardisation is of very high importance. Even though the effect of fishing power on the spawner-recruitment curve was not as marked as for eastern king prawns, fishing gear and technology information for the pre-1988 vessels are needed. The data will reduce the uncertainty in the spawner-recruitment relationship and more clearly define the status of the scallop stock.
- The full-scale fishery-independent saucer scallop surveys provided excellent data for the assessment between 1997 and 2000. Unfortunately the survey scale was reduced to only the replenishment areas after 2000. The full-scale survey should be used to improve estimates of scallop abundance and to help with on-going monitoring of fishing power (Dichmont et al. 2000). The importance of having a catch rate index that is linearly related to abundance cannot be over-emphasised. This can be improved by including survey estimates (Punt et al. 2001b).
- Further development of the stock assessment through the points listed under the eastern king prawn assessment apply (page 161).

8.5.3 Modelling

In this project stock assessment models as described by (Dichmont et al. 2001, Dichmont et al. 1999, and Haddon 2001) were used to analyse populations of eastern king prawns, Torres Strait tiger prawns and saucer scallops. The monthly delay-difference and age-structured models used lognormal likelihood's to estimate parameters on prawn and scallop catchability and recruitment, whereas the annual surplus production models estimated prawn catchability, annual population intrinsic growth rates and virgin stock sizes. Both models assumed standardised catch rates were a reliable index of population abundance. The monthly models were more

applicable as they accurately reflected the important within year pattern of fishing effort. The monthly models allowed for estimation of within year recruitment patterns of the prawns and scallops, and overall the analyses facilitated critical assessment of each trawl sector, thereby making more effective use of the catch and effort data and past biological work on the species. Further enhancements to the delay difference model should be made using the spatial compartmental structures in (Gordon et al. 1995; Hall and Watson 2000) to capture movement dynamics of eastern king prawns, particularly if spatial management strategies are to be assessed. The delay difference model for movement was programmed in Matlab utilising tagging data from Queensland and New South Wales, but was abandoned due to confounding between eastern king prawn movement rates and fishing mortality; further work is required. Difficulties still remain using surplus production models on the prawn and scallop stocks, because the models cannot accurately estimate the population intrinsic growth rate (r) with little contrast in annual catch rates. The parameter r had high correlation with estimated virgin stock size, clouding the status of the stocks. Ideally strong contrasts between catch rates and fishing effort, and a long time-series is required to estimate surplus production parameters with confidence (Hilborn and Walters 1992).

The Monte Carlo and Bootstrap methodologies used here were particularly applicable for evaluating the proposed catch rate reference points, as the simulations allowed for adequate levels of uncertainty in all model parameters and catch data (Haddon 2001; Richards et al. 1998). Overall, the simulation facilitated critical assessment of the important levels of risks associated with, and yields that can be taken from the eastern king prawn, Torres Strait tiger prawn and saucer scallop trawl sectors. It was important to simulate management strategies using appropriate parameter values in the operating population model. This was achieved by tuning parameters from the full stock assessments (Punt et al. 2001b). Outcomes were highly influenced by some parameters. The influence of annual fishing power increases upon the spawner recruitment relationships was particularly influential. The parameter values used provided contrast for assessing how fishing-mortality and catch-rate reference points performed at different population sizes. The results do not necessarily define the future status of the stocks. Some of the key population parameters are based on very old data and experiments, and should be re-measured. New research is needed to modernise estimates of natural mortality for different prawn and scallop sizes, including the use of more robust statistical methods to accurately quantify the uncertainty. This will improve the accuracy of the simulations. There is also uncertainty in regard to how to model the fleet dynamics mixing between trawl sectors. For example, vessels are currently allocated individual nights to fish. If fishing in one sector provided better catches and profits, total catches from other sectors will reduce and this may impact on stock sizes as well as some processors who are reliant on regional landings. Also, current management arrangements do not prevent high levels of fishing effort from being applied to certain trawl sectors, as the management is not sectorised on the Queensland east coast. The fleet dynamics and the pattern of fishing effort can impact on resulting catches and recruitment in following years. Including multiple fleets in the operating simulation model, linking east coast and Torres Strait, may permit trawl fleet dynamics to be assessed.

8.6 REFERENCES

- Annala, J.H. (1993) Report from the Fishery Assessment Plenary, May 1993: stock assessments and yield estimates.
- Bowen, B.K., Hancock, D.A. (1985) Review of penaeid prawn fishery management regimes in Australia. In 'Second Australian National Prawn Seminar'. (Ed. Rothlisberg, P.C., Hill, B.J., Staples, D.J.) pp. 221–29. (NPS2: Cleveland, Queensland).
- Brown, I.W., Dunning, M.C., Hansford, S., Gwynne, L. (2001) 'Ecological Assessment Queensland Spanner Crab Fishery'. Department of Primary Industries, Queensland.
- Courtney, A.J. (1997) Spawning stock dynamics of penaeid prawns in southeast Queensland and considerations for preventing recruitment overfishing. Doctor of Philosophy thesis, University of Queensland.
- Courtney, A.J., Cosgrove, M.G., Mayer, D., Vance, D.J. (2002) 'Developing indicators of recruitment and effective spawner stock levels in eastern king prawns (*Penaeus plebejus*).' Fisheries Research and Development Corporation (FRDC) Final Report, Department of Primary Industries, Queensland, Project #97/145, Brisbane.
- Courtney, A.J., Masel, J.M., Die, D.J. (1995) Temporal and spatial patterns in recruitment of three penaeid prawns in Moreton Bay, Queensland, Australia. *Estuarine, Coastal and Shelf Science* **41**.
- Deriso, R. (2001) 'A review of the 2001 Assessment of Tiger Prawns in the Northern Prawn Fishery.' Inter-American Tropical Tuna Commission, La Jolla, California.
- Deriso, R.B. (1980) Harvesting strategies and parameter estimation for an age-structured model. *Canadian Journal of Fisheries and Aquatic Sciences* **37**, 268–282.
- Dichmont, C.M., Die, D., Punt, A.E., Venables, W., Bishop, J., Deng, A., Dell, Q. (2001) 'Risk analysis and sustainability indicators for prawn stocks in the Northern Prawn Fishery.' CSIRO Marine Research, FRDC 98/109, Cleveland.
- Dichmont, C.M., Dredge, M.C.L., Yeomans, K. (2000) The first large-scale fishery-independent survey of the saucer scallop, *Amusium japonicum balloti* in Queensland, Australia. *Journal of Shellfish Research* **19**, 731–739.
- Dichmont, C.M., Haddon, M., Yeomans, K., Kelly, K. (1999) 'Proceedings of the South-East Queensland Stock Assessment Review Workshop.' Department of Primary Industries, Queensland, Brisbane.
- Die, D.J., Courtney, A.J., Cosgrove, M.G. (1999) 'Effects of Trawl Fishing Closures on Yield and Ex-Vessel Value on the Wide Bay Bar Eastern King Prawn Fishery.' Department of Primary Industries, Queensland, Q199059, Brisbane.

Dredge, M.C.L. (1981) Reproductive Biology of the Saucer Scallop *Amusium japonicum balloti* (Bernardi) in Central Queensland Waters. *Australian Journal of Marine and Freshwater Research* **32**, 775–787.

Dredge, M.C.L. (1985a) Estimates of natural mortality and yield-per-recruit for *Amusium japonicum balloti* Bernardi (Pectinidae) based on tag recoveries. *Journal of Shellfish Research [J. SHELLFISH RES.]* **5**, 103–109.

Dredge, M.C.L. (1985b) Growth and mortality in an isolated bed of saucer scallops, *{Amusium japonicum balloti}* (Bernardi). *Queensland Journal of Agricultural and Animal Sciences* **42**, 11–21.

Dredge, M.C.L. (1988) Recruitment overfishing in a tropical scallop fishery? *Journal of Shellfish Research* **7**, 233–239.

Dredge, M.C.L. (1994) Modelling management measures in the Queensland scallop fishery. *Memoirs of the Queensland Museum* **36**, 277–282.

Francis, R. (1993) Monte Carlo evaluation of risks for biological reference points used in New Zealand fishery assessments. In 'Risk Evaluation and Biological Reference Points for Fisheries Management'. (Eds Smith, S.J., Hunt, J.J. and Rivard, D.) pp. 221–230.

Francis RICC, Shotton, R. (1997) 'Risk' in fisheries management: a review. *Canadian Journal of Fisheries and Aquatic Sciences* **54**, 1699–1715.

Garcia, S. (1985) Reproduction, stock assessment models and population parameters in exploited penaeid shrimp populations. In 'Second Australian National Prawn Seminar'. (Eds Rothlisberg, P.C., Hill, B.J. and Staples, D.J.) pp. 139–158. (NPS2: Cleveland, Australia).

Garcia, S.M., Staples, D.J. (2000) Sustainability reference systems and indicators for responsible marine capture fisheries: a review of concepts and elements for a set of guidelines¹. *Marine & Freshwater Research* **51**, 385–426.

GENSTAT (2002) GENSTAT 6th Edition. In. (Lawes Agricultural Trust).

Glaister, J.P., Lau, T., McDonall, V.C. (1987) Growth and migration of tagged eastern Australian king prawns, *Penaeus plebejus* Hess. *Australian Journal of Marine and Freshwater Research* **38**, 225–242.

Glaister, J.P., Montgomery, S.S., McDonall, V.C. (1990) Yield-per-recruit analysis of eastern king prawns, *Penaeus plebejus* Hess, in eastern Australia. *Australian Journal of Marine and Freshwater Research* **41**, 175–197.

Gordon, G.N.G., Andrew, N.L., Montgomery, S.S. (1995) Deterministic compartmental model for the eastern king prawn (*Penaeus plebejus*) fishery in New South Wales. *Marine and Freshwater Resources* **46**, 793–807.

- Haddon, M. (2001) 'Modelling and Quantitative Methods in Fisheries.' (Chapman and Hall: New York).
- Haddon, M., Hodgson, K. (2000) 'Spatial and Seasonal stock dynamics of Northern Tiger Prawns using fine-scale commercial catch-effort data.' Fisheries Research and Development Corporation Final Report, FRDC 1999/100.
- Hall, N.G., Watson, R.A. (2000) A spatial representation of the tiger prawn (*Penaeus esculentus*) fishery in Shark Bay, Western Australia. In 'Fish Movement and Migration'. (Eds Hancock, D.A., Smith, D.C. and Koehn, J.D.) pp. 212–230. (Australian Society for Fish Biology: Albury).
- Hilborn, R. (2002) The dark side of reference points. *Bulletin of Marine Science* **70**, 403–408.
- Hilborn, R., Walters, C.J. (1992) 'Quantitative Fisheries Stock Assessment: Choice Dynamics and Uncertainty.' (Chapman and Hall: New York).
- Jebreen, E., Yeomans, K., Dredge, M., McGilvray, J., Smallwood, D., Bullock, C., Tonks, M., Dichmont, C. (2003) 'Abundance estimates and an evaluation of permanent scallop replenishment areas for the saucer scallop (*Amusium japonicum balloti*) in Queensland, 1997–2000.' Department of Primary Industries, Queensland, Information Series QI03049.
- Keating, J.A., Watson, R.A., Sterling, D.J. (1990) Reproductive biology of *Penaeus esculentus* (Haswell, 1879) and *Metapenaeus endeavouri* (Schmitt, 1926) in Torres Strait. In 'Torres Strait prawn project: a review of research 1986-1988.' (Ed. Mellors, J.E.) pp. 51–61. (Queensland Department of Primary Industries Information Series, Queensland Department of Primary Industries, QI90018: Brisbane, Australia).
- Kozan, E., Sier, D. (1999) 'Maximising Yield from Queensland's Scallop Resource.' (MISG: Brisbane).
- Leaman, B.M. (1993) Reference points for fisheries management: the western Canadian experience. In 'Risk Evaluation and Biological Reference Points for Fisheries Management' pp. 442. (Canadian Special Publication of Fisheries and Aquatic Sciences: Ottawa).
- Lee, W. (2002) Report on the production issues affecting regional scallop processors during the period 1 July 1999 to 30 June 2002. *Queensland Fisheries Service*, 18p.
- Lucas, C. (1974) Preliminary estimates of stocks of the king prawn, *Penaeus plebejus*, in south-east Queensland. *Aust. J. Mar. Freshwater Res.* **25**, 35–47.
- MATLAB (2002) MATLAB The Language of Technical Computing. In The Math Works Inc: Natick, Massachusetts.
- NORMAC (2001) Milestones and performance measures for the Northern Prawn Fishery. In (NORMAC 51).

O'Neill MF (2002) Use of binary and truncated regression models in the analysis of recreational fish catches. MPhil thesis, University of Queensland.

O'Neill, M.F., Die, D.J., Taylor, B.R., Faddy, M.J. (1998) Accuracy of at-sea commercial size grading of tiger prawns (*Penaeus esculentus* and *P. semisulcatus*) in the Australian northern prawn fishery. *Fishery Bulletin* **97**, 396–401.

Potter, M.A., Dredge, M.C.L. (1985) Deepwater prawn resources off southern and central Queensland. In 'Second Australian National Prawn Seminar'. (Eds Rothlisberg, P.C., Hill, B.J. and Staples, D.J.) pp. 221–29. (NPS2: Cleveland, Queensland).

Prager, M.H. (1994) A suite of extensions to a non-equilibrium surplus-production model. *Fishery Bulletin* **92**, 374–389.

Punt, A.E. (1993) 'PC-BA user's guide (version 1.20).' Department of Applied Mathematics, South Africa.

Punt, A.E., Campbell, R.A., Smith, A.D.M. (2001a) Evaluating empirical indicators and reference points for fisheries management: application to the broadbill swordfish fishery off eastern Australia. *Marine & Freshwater Research* **52**, 819–832.

Punt, A.E., Cui, G., Smith, A.D.M. (2001b) 'Defining robust harvest strategies, performance indicators and monitoring strategies for the SEF.' CSIRO Marine Research, FRDC 98/102, Hobart.

QECTMP (2001) 'Fisheries (East Coast Trawl) Management Plan 1999; *Fisheries Act* 1994.'

Queensland-Fish-Management-Authority (1989) Scallop management changes now in force. In 'Queensland Fisherman, December'.

Quinn, T.J., Deriso, R.B. (1999) 'Quantitative Fish Dynamics.' (Oxford University Press).

Restrepo, V.R., Thompson, G.G., et al. (1998) 'Technical Guidance on the use of Precautionary Approaches to Implementing National Standard 1 of the Magnuson-Stevens Fishery Conservation and Management Act.' National Marine Fisheries Service, NOAA Technical Memorandum NMFS-F/SPO-##.

Richards, L.J., Schnute, J.T., Olsen, N. (1998) A statistical framework for the analysis of limit reference points. In 'Fishery Stock Assessment models'. University of Alaska Fairbanks. (Eds Funk, F., Quinn II, T.J., Heifetz, J., Ianelli, J.N., Powers, J.E., Schweigert, J.F., Sullivan, P.J. and Zhang, C-I.)

Schnute, J. (1985) A general theory for analysis of catch and effort data. *Canadian Journal of Fisheries and Aquatic Sciences* **42**, 414–429.

- Smith, A. (1994) Management Strategy Evaluation — The light on the hill. *Australian Society for Fish Biology Proceedings* Population Dynamics for Fisheries Management, 249–253.
- Turnbull, C., Watson, R.A. (1995) ‘Torres Strait Prawns 1994, Stock Assessment Report, edited by the Torres Strait Fisheries Assessment Group.’ Australian Fisheries Management Authority, Canberra.
- Walters, C., Martell, S.J.D. (2002) Stock assessment needs for sustainable fisheries management. *Bulletin of Marine Science* **70**, 629–638.
- Watson, R.A. (1990) Prawn Fishery Simulation Yield Model. (Ed. Mellors, J.E.). In ‘Torres Strait prawn project: a review of research 1986-1988.’ pp. 125–134. (Queensland Department of Primary Industries Information Series, Queensland Department of Primary Industries, QI90018.: Brisbane, Australia).
- Watson, R.A., Turnbull, C.T. (1993) Migration and growth of two tropical penaeid shrimps within Torres Strait, Northern Australia. *Fisheries Research* **17**, 353–368.
- Williams, L.E. (2002) ‘Queensland Fisheries Resources: Current Condition and Recent Trends 1988–2000.’ Department of Primary Industries, QI02012, Brisbane.
- Williams, M.J., Dredge, M.C.L. (1981) Growth of the Saucer Scallop, *Amusium japonicum balloti* Habe in Central Eastern Queensland. *Aust. J. Mar. Freshwater Res.* **32**, 657–666.
- Ye, Y. (2000) Is recruitment related to spawning stock in penaeid shrimp fisheries? *ICES Journal of Marine Science [ICES J. Mar. Sci.]*. **57**, 1103–1109.

9 CONCLUSION

Summary of the project results and the extent that the objectives were met

Objective 1. Produce an in-depth description of the gear and technological improvements of a representative sample for: a) Torres Strait tiger prawn, b) Queensland eastern king prawn and c) south-east Queensland saucer scallop fisheries 1970 to present.

A detailed description of the changes in fishing gear and technology that have been adopted by vessel owners, operators and skippers in these sectors has been provided (Chapter 5). The types of technologies cover: a) general vessel characteristics (length, engine size, trawl speed, etc.), b) fishing nets (net configurations, net size, ground chains and otter boards, try gear, etc.) and c) electronics (navigational aids, GPS/DGPS, computer mapping software and telecommunications).

The objective was exceeded in that an additional sector, the north Queensland tiger/endeavour prawn sector, was included after the project commenced following a request by industry member Allan Hansen during the project's first Steering Committee meeting. Achievement of the objective was further exceeded because we obtained information on fishing gears and technologies back to the early 1960s — exceeding the initial planned period as defined in the objective.

Objective 2. Establish a standardised catch-per-unit effort series of the above fisheries.

The fishing gear and technology information from 344 past and present owner/operators was 'married' to their individual catch and effort data from the compulsory CFISH logbook database. The effects of changes were then quantified using generalised linear modelling, the details of which are described in Chapter 6. This modelling exercise produced estimates of the average annual increases in fishing power for each sector. Annual rates of increase in fishing power varied between the sectors; the highest rate occurred in the shallow water eastern king prawn fishery (1.6%) and the lowest occurred in the scallop fishery (0.2%). This equates to a 27% increase in fishing power in the shallow water king prawn fishery and a 4% increase in scallop fishery over the 11 fishing-year period 1989–1999. The results were published in *Fisheries Research* [Vol. 65 (2003) 309–321] and have been used to produce standardised time series of catch rates in each sector and to facilitate a comparison with unstandardised (nominal) catch rates. The annual increases in fishing power have been incorporated in stock assessment models and their effects on stock-recruitment relationships in each sector have also been considered. QFS staff are also using the annual fishing power increments to adjust catch rate time series reporting purposes. Over the past two years there have been marked changes in the composition of the Queensland trawl fleet, following the introduction of the Management Plan. The study has highlighted the need to continue initiatives designed to quantify changes in fishing power in the fleet and update fishing power estimates.

Objective 3. Compare present Management Plan reference points with the standardised and unstandardised catch-per-unit-effort series.

The Queensland Trawl Fishery Management Plan defines catch rate reference points for the major stocks, such that review events are required when catch rates fall below 70% of those reported for the period 1988–97. While the Plan specifies monthly periods of recruitment and spawning that the reference catch rates refer to for each stock, there is still considerable ambiguity in relation to how the reference points are to be derived (i.e. spatial definitions of stocks, whether monthly catch rates should be pooled, etc) and because of this uncertainty we compared the standardised and unstandardised catch rates for a range of possible interpretations. The exercise was limited to the eastern king prawn, scallop and north Queensland tiger prawns, as the Torres Strait fishery is managed separately from the Queensland east coast trawl fishery and at present has no specified reference points. Reference points were triggered for the 1998 and 2000 fishing year for scallops when catch rates were calculated by season and all grids combined, but only the 1998 fishing year was triggered if only the traditional scallop grids were used. Similar patterns arose when using monthly data. No review events were triggered for the eastern king prawn or north Queensland tiger prawns using seasonal catch rates. However, a review event was triggered when monthly catch rates were used in the eastern king prawn shallow sector using all grids for two out of four months for the 2000 fishing year. One month triggered a review event in the 2000 fishing year for north Queensland tiger prawn. No actions have been implemented in response to the catch rates falling below the reference points. The work has highlighted the need to: a) better define the catch rate reference points as they are currently stated in the Management Plan, b) determine an acceptable risk of catch rates falling below a reference point, and c) instigate a formal process of comparing standardised catch rates and reference points annually, and employ appropriate management strategies when a review event is triggered.

Objective 4. Investigate and establish robust reference points and response mechanisms through simulation modelling.

For this objective stock assessment models were developed that incorporated stock-recruitment relationships and the annual increases in fishing power to evaluate the Plan's 70% catch rate reference point and possible alternatives. The models tested management responses to the triggered reference points of 60%, 70%, and 80% of the average catch rate. Three model-based reference points targeting fishing effort at maximum sustainable yield (E_{MSY}), $3/4E_{MSY}$ and $2/3E_{MSY}$ were also examined. The catch rate reference points resulted in sustainable levels of fishing, but can trigger at high population sizes and cause inappropriate changes in fishing effort. Similarly, catch rates for low population sizes may not necessarily fall below the catch rate trigger. In general, we found that the reference points targeting fishing effort to $2/3E_{MSY}$ or $3/4E_{MSY}$ maintained populations slightly above the size that supports maximum sustainable yield. These reference points resulted in lower risks of under or overfishing, improved catches and higher catch rates. The stock assessments suggest all three stocks (eastern king prawn, Torres Strait tiger prawn, and saucer scallop) were fished to the limit of maximum sustainable yields, but eastern king prawn population sizes prior to 2001 may have been lower than this. All results were sensitive to the spawner-recruitment relationships and the estimates of annual increases in fishing power. The work has highlighted the need to: a) undertake fishery

independent estimates of abundance (i.e. surveys) that can be incorporated in the assessments, b) apply the vessel monitoring system (VMS) data to improve the spatial definition of stocks, c) continually update estimates of annual increases in fishing power as a result of the fleet adopting new technology, and, importantly, d) promote greater industry and management involvement (primarily through the TrawlMAC) to identify the most effective reference points for the stocks and to set acceptable levels of risk. This industry and management involvement is necessary because until specific management strategies are defined there can be no explicit answer to the likelihood that managers and industry will achieve objectives of sustaining the stock and maximise value from the resource.

Objective 5. Disseminate results to TrawlMAC, the QFMA (since changed to Queensland Fisheries Service, QFS) trawl fishery manager and fishers.

The results have been presented and provided to TrawlMAC and the scientific advisory group (SAG), the fishing industry, fishery managers, the science community and members of the GBRMPA. A summary of presentations is provided in Table 9.1.

We have provided presentations of the work to: a) the Torres Strait Working Group and included the Torres Strait Prawn Entitlement Holders Association (TSPEHA) and both state (QFS) and federal (AFMA) fishery managers, b) the Queensland TrawlMAC and scientific advisory group (SAG), c) special management meetings with scallop fishers, processors and QFS trawl managers, d) a Mooloolaba branch meeting of the Queensland Seafood Industry Association (QSIA) whose members principally target eastern king prawns, and e) the Project's Steering Committee, which comprised industry representatives, the fishery managers and project staff.

Table 9.1 The list of meetings where project results were presented.

	Meeting details	Date
1	First steering committee meeting, Deception Bay	September–99
2	Second steering committee meeting, Deception Bay	October–00
3	Genstat Conference, Surfers Paradise	January–01
4	Torres Strait fishers boat replacement policy, Cairns	February–01
5	Southern Fisheries Centre seminar, Deception Bay	March–01
6	TrawlMAC, Brisbane	March–01
7	Special QFS presentation, Brisbane	June–01
8	EDFAM in A Coruna, Spain	October–01
9	Special TrawlMAC subcommittee for reviewing reference points, Deception Bay	June–02
10	Trawl Fishery SAG, Brisbane	November–02
11	QFS General Effort Review (GER) meeting, Brisbane	January–03
12	Moreton Bay boat replacement policy review, Deception Bay	March–03
13	Special QFS scallop meeting, Brisbane	April–03
14	Mooloolaba meeting of QSIA branch members	April–03
15	Moreton Bay boat replacement policy meeting, Deception Bay	May–03
16	Third steering committee meeting, Deception Bay	July–03
17	QFS scallop crisis meeting, Brisbane	October–03
18	Torres Strait prawn fishers and AFMA and QFS managers, Cairns	October–03
19	QFS meeting of scallop processors and fishers, Brisbane	November–03
20	TrawlMAC (eastern king prawn stock assessment), Brisbane	December–03

Aspects of the study were also presented by M. O'Neill at: a) 'Life Histories, Assessment and Management of Crustacean Fisheries Conference' organised by EDFAM in A Coruna, Spain, October 2001 and b) the 'Australian Genstat Conference (GENSTAT 2001)' in Surfers Paradise, Queensland, Australia, January 2001. The stock assessment of the Torres Strait prawn fishery was independently reviewed by Dr. David Die (University of Miami, USA) in October 2003 as contracted by the AFMA (report of the review available through AFMA).

10 BENEFITS AND ADOPTION

The beneficiaries of the research are a) members of the Queensland Seafood Industry Association (QSIA), especially trawl fishers and processors who are reliant upon the eastern king prawn, saucer scallop and tiger prawn stocks for their income, b) Torres Strait trawl fishers and c) the state (QFS) and commonwealth agencies (AFMA) responsible for the management of these fisheries. The eastern king prawn fishery is based on a single migratory stock that is shared by Queensland and New South Wales and since the standardisation of catch rates and the stock assessment model included the New South Wales catch and effort data, there are also benefits for New South Wales trawl fishers and managers.

It is difficult to quantify the benefits of the research in terms of price or value of the stocks. However, the collective value of the Torres Strait tiger prawn, Queensland scallop and the eastern king prawn stocks is currently in the order of \$60 million annually and so it is important to note that even small increases in the yield of these stocks, or conversely, small decreases in the risk of overfishing as a result of the research, can have potential fiscal benefits of several million dollars.

The research provided a number of benefits and added to our understanding and assessment of the stocks. The project has:

- quantified rates of change in fishing gear and technology and more importantly, their influence on fishing power. We now have quantitative annual estimates of increases in fishing power in each of the major trawl sectors.
- produced standardised time series of catch per unit effort (rather than unstandardised). The annual fishing power increments are also being considered by the Great Barrier Reef Marine Park Authority for the purposes of capping and reducing annual trawl effort levels within the Park.
- developed stock assessment models for the major trawl stocks in Queensland and Torres Strait that consider the influence of annual increases in fishing power on catch rates and stock-recruitment relationships.
- evaluated the Management Plan's catch rate reference point and put forward alternative reference points that may offer greater resource security and less risk of overfishing.
- identified future research needs for the stocks.

11 FURTHER DEVELOPMENT

There is a need to continually update the catalogue for trawler fishing gears and technologies to estimate average annual increases in fishing power and standardise catch rates. Fishing power estimates were estimated up to the calendar year 2000 and are now being applied to standardise data, improve stock-recruitment relationships and to forecast and evaluate management strategies. It is, therefore, imperative that the most up-to-date data and accurate estimates are used. Since 1999, and following the introduction of the Management Plan, there have been major changes in the structure fleet, including a reduction in licensed vessels from around 800 to about 500. This has affected each sector differently. There is, therefore, a need to update the average annual increases in fishing power and this could be achieved using a similar questionnaire approach as used herein, or using 'gear sheets' that are completed by fishers with logbook returns, or possibly a combination of the two.

There is a strong need for the TrawlMAC and the SAG to become more actively involved in the stock assessment process, specifically in regard to identifying target reference points and in setting acceptable levels of risk of overfishing. This can be achieved by continuing to present the project results to TrawlMAC and by educating the committee's members to become familiar with stock assessment terms and objectives. There is also a need for TrawlMAC to acknowledge that Queensland east coast and Torres Strait trawl fisheries comprise separate and distinguish stocks that require individual assessments and management. There is also a need for Queensland and New South Wales fishery managers to jointly assess and manage the eastern king prawn fishery as a single stock.

The project has produced the first stock-recruitment relationships (SRRs) for the Torres Strait tiger prawns, saucer scallops and eastern king prawn stocks. The eastern king prawn and saucer scallop SRRs in particular, could be improved by further standardising the pre-1989 catch rate data.

12 ACKNOWLEDGMENTS

The project was jointly funded by the Fisheries Research and Development Corporation (FRDC Project #99/120) and the Queensland Department of Primary Industries and we gratefully acknowledge their support. The work would not have been possible without the efforts of many people and special thanks go to the trawler owners and skippers who provided details on their vessels' fishing gears and technologies.

We would also like to thank the members of project's steering committee: Allan Hansen (QSIA), Robin Hansen (QSIA), Duncan Souter (QSIA), David Sterling (D.J. Sterling Trawl Gear Services), Brigid Kerrigan (QFS), Andrew Thwaites (QFS), Janet Bishop (CSIRO), Cathy Dichmont (CSIRO) and Yemin Ye (CSIRO). Their guidance helped greatly in designing the fishing technology questionnaire and in interpreting results from all the modelling. Cathy also played a leading role in the initial development of the project proposal.

Janet Bishop, Cathy Dichmont, and David Mayer (DPI&F/AFFS) provided statistical and modelling advice. The long term monitoring team from the QFS provided data from their annual scallop survey, which provided essential information to improve the

scallop stock assessment. Mike Dredge, George Leigh and James Scandol made constructive comments on earlier versions of this report. We thank David Die (University of Miami, Florida, USA) for constructively reviewing the Torres Strait component of the work, as part of the independent review that was jointly funded by the QFS and AFMA.

We also thank the Southern Fisheries Centre staff of Tony White, Natalie Judson, Keely Moran, Kelly Deering and Bob Cooper for administrative and financial assistance associated with the project.

13 INTELLECTUAL PROPERTY

No intellectual property has arisen from the work.

14 STAFF

Staff engaged on the project were:

Tony Courtney and Michael O'Neill (joint project Principal Investigators)

Clive Turnbull (Co-investigator)

Norm Good

Michael Cosgrove

Kate Yeomans

Jonathon Staunton-Smith

Celeste Shootingstar

David Mayer

15 APPENDICES

15.1 REFERENCE POINT RESULTS FOR 5 AND 20 YEAR PROJECTIONS

15.1.1 Eastern King Prawns

Table 15.1.1.1 Performance of the 60% CPUE reference points and one-way management responses measured against different biological and fishing industry objectives. Table (a) outlines the simulation details, Table (b) summaries the overfishing probabilities and expected median population sizes; the shaded cells indicated scenarios where 5-year biomass ratios B_{t+5}/B_{MSY} , are above one, and Table (c) summaries the expected median catch statistics and mean number of triggered reference points; the shaded cells highlight the scenarios that result in the best catches, lowest catch variation, highest fishing effort and catch rates, and the lowest number of catch-rate triggers.

(a) Simulation Details

Trawl Sector: Eastern King Prawns; **Model:** Monthly Delay Difference; **Recruitment Models:** Beverton-Holt; **Reference Points:** Limit - 60% CPUE; Upper - None.
Management Response to Triggered Reference Points: 10% – reduce fishing effort by 10%; 30% - reduce fishing effort by 30%

(b) Biological Measures

Management Response for Ref. Pts	Test Fishing Nights	5yr Probability $B_{t+5}<20\%K$	20yr Probability $B_{t+20}<20\%K$	5yr Probability $B_{t+5}<B_{MSY}$	20yr Probability $B_{t+20}<B_{MSY}$	5yr Biomass Ratio B_{t+5}/K	20yr Biomass Ratio B_{t+20}/K	5yr Biomass Ratio B_{t+5}/B_{MSY}	20yr Biomass Ratio B_{t+20}/B_{MSY}
30%	45 000	0.27	0.16	0.72	0.59	0.29	0.34	0.76	0.89
30%	40 000	0.23	0.17	0.65	0.60	0.32	0.33	0.84	0.87
30%	35 000	0.14	0.16	0.59	0.61	0.35	0.33	0.92	0.86
30%	30 000	0.08	0.09	0.49	0.54	0.40	0.36	1.05	0.95
30%	25 000	0.04	0.04	0.37	0.40	0.46	0.42	1.21	1.09
30%	20 000	0.01	0.01	0.24	0.24	0.53	0.49	1.39	1.29
30%	15 000	0.00	0.00	0.14	0.08	0.62	0.58	1.62	1.54
10%	45 000	0.34	0.31	0.75	0.75	0.25	0.26	0.68	0.70
10%	40 000	0.26	0.28	0.68	0.72	0.29	0.27	0.77	0.72
10%	35 000	0.17	0.22	0.61	0.68	0.33	0.30	0.89	0.77
10%	30 000	0.10	0.12	0.51	0.58	0.38	0.34	1.02	0.90
10%	25 000	0.05	0.05	0.38	0.43	0.45	0.40	1.18	1.06
10%	20 000	0.02	0.01	0.25	0.25	0.52	0.48	1.37	1.27
10%	15 000	0.01	0.00	0.15	0.09	0.61	0.57	1.61	1.52

(c) Fishing Industry Measures

Management Response for Ref. Pts	Test Fishing Nights	5yr Catch (t)	20yr Catch (t)	5yr Catch Variation	20yr Catch Variation	5yr Fishing Nights	20yr Fishing Nights	5yr CPUE (kg/boat day)	20yr CPUE (kg/boat day)	5yr No. Limit Triggers	20yr No. Limit Triggers
30%	45 000	2841	2939	0.15	0.22	44 999	31 499	67	78	0.7	1.5
30%	40 000	2873	2970	0.14	0.21	39 999	27 999	72	76	0.5	1.1
30%	35 000	2873	3028	0.14	0.20	35 000	34 999	81	76	0.3	0.7
30%	30 000	2809	3069	0.15	0.19	29 999	29 999	93	83	0.3	0.5
30%	25 000	2689	3027	0.15	0.19	24 999	24 999	109	96	0.2	0.3
30%	20 000	2501	2900	0.16	0.20	19 999	19 999	126	116	0.2	0.3
30%	15 000	2213	2623	0.17	0.20	14 999	14 999	148	140	0.2	0.3
10%	45 000	2883	2889	0.13	0.20	44 999	36 449	60	63	0.9	2.7
10%	40 000	2908	2952	0.13	0.20	39 999	35 999	68	64	0.5	1.8
10%	35 000	2905	3029	0.14	0.19	35 000	34 999	78	69	0.4	1.0
10%	30 000	2842	3066	0.14	0.19	29 999	29 999	91	79	0.3	0.6
10%	25 000	2730	3034	0.15	0.19	24 999	24 999	106	94	0.2	0.4
10%	20 000	2544	2925	0.16	0.20	19 999	19 999	123	114	0.2	0.3
10%	15 000	2238	2649	0.17	0.20	14 999	14 999	146	139	0.2	0.3

Table 15.1.1.2 Performance of the 70% CPUE reference points and one-way management responses measured against different biological and fishing industry objectives. Table (a) outlines the simulation details, Table (b) summaries the overfishing probabilities and expected median population sizes; the shaded cells indicated scenarios where 5-year biomass ratios B_{t+5}/B_{MSY} , are above one, and Table (c) summaries the expected median catch statistics and mean number of triggered reference points; the shaded cells highlight the scenarios that result in the best catches, lowest catch variation, highest fishing effort and catch rates, and the lowest number of catch-rate triggers.

(a) Simulation details

Trawl Sector: Eastern King Prawns; **Model:** Monthly Delay Difference; **Recruitment Models:** Beverton-Holt; **Reference Points:** Limit –70% CPUE; Upper - None.
Management Response to Triggered Reference Points: 10% – reduce fishing effort by 10%; 30% - reduce fishing effort by 30%;.

(b) Biological Measures

Management Response for Ref. Pts	Test Fishing Nights	5yr Probability $B_{t+5} < 20\%K$	20yr Probability $B_{t+20} < 20\%K$	5yr Probability $B_{t+5} < B_{MSY}$	20yr Probability $B_{t+20} < B_{MSY}$	5yr Biomass Ratio B_{t+5}/K	20yr Biomass Ratio B_{t+20}/K	5yr Biomass Ratio B_{t+5}/B_{MSY}	20yr Biomass Ratio B_{t+20}/B_{MSY}
30%	45 000	0.20	0.07	0.66	0.46	0.33	0.40	0.86	1.07
30%	40 000	0.15	0.08	0.61	0.48	0.35	0.38	0.93	1.01
30%	35 000	0.10	0.09	0.54	0.50	0.38	0.38	1.01	1.00
30%	30 000	0.06	0.07	0.45	0.45	0.42	0.40	1.13	1.06
30%	25 000	0.03	0.03	0.32	0.34	0.48	0.44	1.28	1.18
30%	20 000	0.01	0.01	0.22	0.19	0.55	0.52	1.46	1.36
30%	15 000	0.00	0.00	0.12	0.07	0.63	0.60	1.67	1.59
10%	45 000	0.31	0.21	0.74	0.68	0.27	0.30	0.72	0.79
10%	40 000	0.23	0.20	0.67	0.66	0.31	0.30	0.81	0.80
10%	35 000	0.15	0.16	0.60	0.64	0.35	0.32	0.91	0.84
10%	30 000	0.09	0.11	0.50	0.55	0.40	0.35	1.04	0.93
10%	25 000	0.05	0.05	0.37	0.41	0.45	0.41	1.19	1.09
10%	20 000	0.02	0.01	0.25	0.24	0.53	0.49	1.38	1.28
10%	15 000	0.01	0.00	0.14	0.09	0.62	0.58	1.63	1.53

(c) Fishing Industry Measures

Management Response for Ref. Pts	Test Fishing Nights	5yr Catch (t)	20yr Catch (t)	5yr Catch Variation	20yr Catch Variation	5yr Fishing Nights	20yr Fishing Nights	5yr CPUE (kg/boat day)	20yr CPUE (kg/boat day)	5yr No. Limit Triggers	20yr No. Limit Triggers
30%	45 000	2755	2947	0.16	0.22	31 499	22 050	77	92	1.1	2.0
30%	40 000	2784	2983	0.15	0.21	28 000	27 999	82	89	0.9	1.6
30%	35 000	2795	3021	0.15	0.20	34999	24 499	89	89	0.7	1.2
30%	30 000	2742	3053	0.15	0.20	29 999	21 000	99	93	0.5	0.8
30%	25 000	2627	2977	0.16	0.20	24 999	24 999	113	104	0.4	0.7
30%	20 000	2409	2831	0.17	0.20	19 999	19 999	130	120	0.4	0.6
30%	15 000	2124	2535	0.17	0.20	14 999	14 999	150	143	0.4	0.5
10%	45 000	2858	2934	0.13	0.20	40 499	29 524	65	72	1.5	3.8
10%	40 000	2896	2978	0.13	0.20	36 000	32 399	71	72	1.1	2.8
10%	35 000	2887	3036	0.14	0.19	34 999	31 499	81	76	0.8	1.8
10%	30 000	2830	3062	0.14	0.19	29 999	27 000	93	83	0.6	1.1
10%	25 000	2712	3031	0.15	0.19	24 999	24 999	107	97	0.5	0.8
10%	20 000	2512	2910	0.16	0.20	19 999	19 999	125	116	0.4	0.6
10%	15 000	2218	2626	0.17	0.20	14 999	14 999	147	140	0.4	0.5

Table 15.1.1.3 Performance of the 80% CPUE reference points and one-way management responses measured against different biological and fishing industry objectives. Table (a) outlines the simulation details, Table (b) summaries the overfishing probabilities and expected median population sizes; the shaded cells indicated scenarios where 5-year biomass ratios B_{t+5}/B_{MSY} , are above one, and Table (c) summaries the expected median catch statistics and mean number of triggered reference points; the shaded cells highlight the scenarios that result in the best catches, lowest catch variation, highest fishing effort and catch rates, and the lowest number of catch-rate triggers.

(a) Simulation details.

Trawl Sector: Eastern King Prawns; **Model:** Monthly Delay Difference; **Recruitment Models:** Beverton-Holt; **Reference Points:** Limit - 80% CPUE; Upper - None. **Management Response to Triggered Reference Points:** 10% – reduce fishing effort by 10%; 30% – reduce fishing effort by 30%.

(b) Biological Measures

Management Response for Ref. Pts	Test Fishing Nights	5yr Probability $B_{t+5} < 20\%K$	20yr Probability $B_{t+20} < 20\%K$	5yr Probability $B_{t+5} < B_{MSY}$	20yr Probability $B_{t+20} < B_{MSY}$	5yr Biomass Ratio B_{t+5}/K	20yr Biomass Ratio B_{t+20}/K	5yr Biomass Ratio B_{t+5}/B_{MSY}	20yr Biomass Ratio B_{t+20}/B_{MSY}
30%	45 000	0.14	0.04	0.60	0.36	0.39	0.43	1.03	1.15
30%	40 000	0.11	0.04	0.54	0.37	0.39	0.44	1.04	1.16
30%	35 000	0.08	0.04	0.49	0.39	0.42	0.43	1.10	1.14
30%	30 000	0.04	0.03	0.40	0.36	0.46	0.44	1.21	1.17
30%	25 000	0.02	0.01	0.28	0.27	0.50	0.48	1.34	1.26
30%	20 000	0.01	0.00	0.19	0.16	0.57	0.54	1.51	1.43
30%	15 000	0.00	0.00	0.11	0.06	0.65	0.63	1.72	1.65
10%	45 000	0.3	0.1	0.7	0.6	0.3	0.3	0.8	0.9
10%	40 000	0.2	0.1	0.6	0.6	0.3	0.3	0.8	0.9
10%	35 000	0.1	0.1	0.6	0.6	0.4	0.3	1.0	0.9
10%	30 000	0.1	0.1	0.5	0.5	0.4	0.4	1.1	1.0
10%	25 000	0.0	0.0	0.4	0.4	0.5	0.4	1.2	1.1
10%	20 000	0.0	0.0	0.2	0.2	0.5	0.5	1.4	1.3
10%	15 000	0.0	0.0	0.1	0.1	0.6	0.6	1.6	1.6

(c) Fishing Industry Measures

Management Response for Ref. Pts	Test Fishing Nights	5yr Catch (t)	20yr Catch (t)	5yr Catch Variation	20yr Catch Variation	5yr Fishing Nights	20yr Fishing Nights	5yr CPUE (kg/boat day)	20yr CPUE (kg/boat day)	5yr No. Limit Triggers	20yr No. Limit Triggers
30%	45 000	2628	2935	0.17	0.22	22 050	22 049	90	102	1.6	2.4
30%	40 000	2679	2949	0.16	0.21	27 999	19 600	93	101	1.3	2.1
30%	35 000	2701	2966	0.16	0.21	24 499	24 499	98	101	1.0	1.7
30%	30 000	2662	2986	0.16	0.21	20 999	20 999	106	104	0.9	1.3
30%	25 000	2547	2921	0.17	0.20	17 500	17 500	120	112	0.7	1.0
30%	20 000	2337	2782	0.17	0.20	14 000	14 000	135	127	0.6	0.9
30%	15 000	2012	2459	0.18	0.21	14 999	14 999	156	149	0.6	0.8
10%	45 000	2819	2965	0.14	0.21	36 449	26 572	70	81	2.3	4.9
10%	40 000	2867	2991	0.13	0.20	35 999	29 159	76	81	1.7	3.8
10%	35 000	2862	3029	0.14	0.20	31 499	28 349	84	83	1.3	2.8
10%	30 000	2810	3052	0.15	0.19	26 999	26 999	96	89	1.0	1.8
10%	25 000	2682	3024	0.15	0.19	22 500	22 500	110	99	0.8	1.3
10%	20 000	2494	2896	0.16	0.20	18 000	18 000	126	118	0.7	1.0
10%	15 000	2204	2604	0.17	0.20	14 999	14 999	148	141	0.6	0.8

Table 15.1.1.4 Performance of the 60% CPUE reference points and two-way management responses measured against different biological and fishing industry objectives. Table (a) outlines the simulation details, Table (b) summaries the overfishing probabilities and expected median population sizes; the shaded cells indicated scenarios where 5-year biomass ratios B_{t+5}/B_{MSY} , are above one, and Table (c) summaries the expected median catch statistics and mean number of triggered reference points; the shaded cells highlight the scenarios that result in the best catches, lowest catch variation, highest fishing effort and catch rates, and the lowest number of catch-rate triggers.

(a) Simulation details.

Trawl Sector: Eastern King Prawns; **Model:** Monthly Delay Difference; **Recruitment Models:** Beverton-Holt; **Reference Points:** Limit - 60% CPUE; Upper – 95% percentile. **Management Response to Triggered Reference Points:** 10/5% – reduce fishing effort by 10% or increase by 5%; 30/15% – reduce fishing effort by 30% or increase by 15%.

(b) Biological Measures

Management Response for Ref. Pts	Test Fishing Nights	5yr Probability $B_{t+5} < 20\%K$	20yr Probability $B_{t+20} < 20\%K$	5yr Probability $B_{t+5} < B_{MSY}$	20yr Probability $B_{t+20} < B_{MSY}$	5yr Biomass Ratio B_{t+5}/K	20yr Biomass Ratio B_{t+20}/K	5yr Biomass Ratio B_{t+5}/B_{MSY}	20yr Biomass Ratio B_{t+20}/B_{MSY}
30/15%	45 000	0.27	0.25	0.72	0.68	0.28	0.29	0.76	0.77
30/15%	40 000	0.23	0.25	0.66	0.69	0.30	0.29	0.81	0.78
30/15%	35 000	0.14	0.25	0.60	0.69	0.33	0.29	0.87	0.76
30/15%	30 000	0.08	0.26	0.51	0.68	0.36	0.29	0.96	0.76
30/15%	25 000	0.04	0.25	0.41	0.68	0.41	0.29	1.07	0.77
30/15%	20 000	0.02	0.25	0.29	0.68	0.45	0.29	1.18	0.77
30/15%	15 000	0.01	0.28	0.17	0.68	0.52	0.28	1.37	0.75
10/5%	45 000	0.34	0.33	0.75	0.76	0.25	0.26	0.68	0.69
10/5%	40 000	0.26	0.31	0.68	0.74	0.29	0.26	0.76	0.69
10/5%	35 000	0.17	0.29	0.61	0.71	0.33	0.28	0.87	0.74
10/5%	30 000	0.10	0.24	0.52	0.67	0.37	0.29	0.99	0.77
10/5%	25 000	0.05	0.21	0.40	0.63	0.43	0.31	1.14	0.81
10/5%	20 000	0.02	0.18	0.27	0.58	0.49	0.33	1.30	0.87
10/5%	15 000	0.01	0.09	0.16	0.49	0.58	0.37	1.52	0.98

(c) Fishing Industry Measures

Management Response for Ref. Pts	Test Fishing Nights	5yr Catch (t)	20yr Catch (t)	5yr Catch Variation	20yr Catch Variation	5yr Fishing Nights	20yr Fishing Nights	5yr CPUE (kg/boat day)	20yr CPUE (kg/boat day)	5yr No. Limit Triggers	20yr No. Limit Triggers	5yr No. Upper Triggers	20yr No. Upper Triggers
30/15%	45 000	2847	2924	0.15	0.23	44 999	31 499	66	69	0.7	1.8	0.1	1.4
30/15%	40 000	2876	2952	0.14	0.22	39 999	30 772	71	69	0.5	1.4	0.2	1.4
30/15%	35 000	2893	2996	0.15	0.22	35 000	32 401	79	68	0.3	1.2	0.5	1.6
30/15%	30 000	2854	3007	0.15	0.22	30 000	31 938	87	69	0.3	1.0	0.9	2.4
30/15%	25 000	2806	3015	0.17	0.23	28 749	30 607	96	70	0.2	1.0	1.4	3.4
30/15%	20 000	2737	3028	0.20	0.24	26 449	30 417	106	70	0.2	0.9	2.2	4.8
30/15%	15 000	2562	3002	0.24	0.26	22 813	30 170	123	70	0.2	0.8	2.8	6.5
10/5%	45 000	2883	2885	0.13	0.21	44 999	36 449	60	62	0.9	2.8	0.1	0.4
10/5%	40 000	2908	2945	0.13	0.20	39 999	35 999	68	62	0.5	1.9	0.2	0.7
10/5%	35 000	2907	3011	0.14	0.20	35 000	34 999	77	64	0.4	1.2	0.4	1.4
10/5%	30 000	2854	3057	0.14	0.20	30 000	32 818	89	68	0.3	0.8	0.8	2.9
10/5%	25 000	2772	3066	0.15	0.20	26 250	31 659	101	72	0.2	0.5	1.4	5.1
10/5%	20 000	2626	3059	0.17	0.21	22 050	29 549	117	77	0.2	0.4	2.2	8.1
10/5%	15 000	2361	2990	0.19	0.23	17 364	26 937	137	88	0.2	0.3	2.9	11.5

Table 15.1.1.5 Performance of the 70% CPUE reference points and two-way management responses measured against different biological and fishing industry objectives. Table (a) outlines the simulation details, Table (b) summaries the overfishing probabilities and expected median population sizes; the shaded cells indicated scenarios where 5-year biomass ratios B_{t+5}/B_{MSY} , are above one, and Table (c) summaries the expected median catch statistics and mean number of triggered reference points; the shaded cells highlight the scenarios that result in the best catches, lowest catch variation, highest fishing effort and catch rates, and the lowest number of catch-rate triggers.

(a) Simulation details.

Trawl Sector: Eastern King Prawns; **Model:** Monthly Delay Difference; **Recruitment Models:** Beverton-Holt; **Reference Points:** Limit - 70% CPUE; Upper – 95% percentile. **Management Response to Triggered Reference Points:** 10/5% – reduce fishing effort by 10% or increase by 5%; 30/15% – reduce fishing effort by 30% or increase by 15%.

(b) Biological Measures.

Management Response for Ref. Pts	Test Fishing Nights	5yr Probability $B_{t+5} < 20\%K$	20yr Probability $B_{t+20} < 20\%K$	5yr Probability $B_{t+5} < B_{MSY}$	20yr Probability $B_{t+20} < B_{MSY}$	5yr Biomass Ratio B_{t+5}/K	20yr Biomass Ratio B_{t+20}/K	5yr Biomass Ratio B_{t+5}/B_{MSY}	20yr Biomass Ratio B_{t+20}/B_{MSY}
30/15%	45 000	0.20	0.18	0.66	0.62	0.32	0.32	0.85	0.83
30/15%	40 000	0.16	0.18	0.61	0.61	0.34	0.32	0.91	0.86
30/15%	35 000	0.11	0.18	0.56	0.62	0.36	0.32	0.95	0.85
10/5%	45 000	0.31	0.23	0.74	0.69	0.27	0.29	0.72	0.76
10/5%	40 000	0.23	0.24	0.67	0.69	0.30	0.29	0.80	0.77
10/5%	35 000	0.16	0.23	0.60	0.68	0.34	0.30	0.90	0.79

(c) Fishing Industry Measures

Management Response for Ref. Pts	Test Fishing Nights	5yr Catch (t)	20yr Catch (t)	5yr Catch Variation	20yr Catch Variation	5yr Fishing Nights	20yr Fishing Nights	5yr CPUE (kg/boat day)	20yr CPUE (kg/boat day)	5yr No. Limit Triggers	20yr No. Limit Triggers	5yr No. Upper Triggers	20yr No. Upper Triggers
30/15%	45 000	2766	2951	0.16	0.24	31 499	29 161	76	77	1.1	2.5	0.2	2.4
30/15%	40 000	2827	2974	0.15	0.24	32 200	27 999	79	78	0.9	2.2	0.4	2.4
30/15%	35 000	2846	2996	0.15	0.23	34 999	28 174	83	77	0.7	1.9	0.6	2.6
30/15%	30 000	2818	3007	0.16	0.23	29 999	29 353	90	76	0.5	1.7	1.0	3.2
30/15%	25 000	2768	3022	0.18	0.24	26 615	28 334	100	78	0.5	1.6	1.6	4.1
30/15%	20 000	2660	3017	0.21	0.25	24 486	28 159	110	77	0.4	1.5	2.3	5.4
30/15%	15 000	2470	3002	0.25	0.27	22 813	27 930	127	76	0.4	1.3	2.9	7.0
10/5%	45 000	2858	2921	0.13	0.21	40 499	32 550	65	70	1.5	4.0	0.1	0.8
10/5%	40 000	2896	2972	0.13	0.20	36 000	32 399	70	69	1.1	3.0	0.2	1.1
10/5%	35 000	2889	3018	0.14	0.20	34 999	31 500	80	70	0.8	2.1	0.4	1.8
10/5%	30 000	2846	3057	0.15	0.20	29 999	31 255	90	71	0.6	1.5	0.9	3.2
10/5%	25 000	2758	3073	0.16	0.20	26 046	30 387	103	74	0.5	1.1	1.5	5.4
10/5%	20 000	2602	3063	0.17	0.21	21 879	29 320	118	78	0.4	0.8	2.3	8.4
10/5%	15 000	2336	2989	0.19	0.23	17 364	26 937	138	89	0.4	0.6	2.9	11.7

Table 15.1.1.6 Performance of the 80% CPUE reference points and two-way management responses measured against different biological and fishing industry objectives. Table (a) outlines the simulation details, Table (b) summaries the overfishing probabilities and expected median population sizes; the shaded cells indicated scenarios where 5-year biomass ratios B_{t+5}/B_{MSY} , are above one, and Table (c) summaries the expected median catch statistics and mean number of triggered reference points; the shaded cells highlight the scenarios that result in the best catches, lowest catch variation, highest fishing effort and catch rates, and the lowest number of catch-rate triggers.

(a) Simulation Details

Trawl Sector: Eastern King Prawns; **Model:** Monthly Delay Difference; **Recruitment Models:** Beverton-Holt; **Reference Points:** Limit - 80% CPUE; Upper - 95% percentile. **Management Response to Triggered Reference Points:** 10/5% - reduce fishing effort by 10% or increase by 5%; 30/15% - reduce fishing effort by 30% or increase by 15%.

(b) Biological Measures

Management Response for Ref. Pts	Test Fishing Nights	5yr Probability $B_{t+5} < 20\%K$	20yr Probability $B_{t+20} < 20\%K$	5yr Probability $B_{t+5} < B_{MSY}$	20yr Probability $B_{t+20} < B_{MSY}$	5yr Biomass Ratio B_{t+5}/K	20yr Biomass Ratio B_{t+20}/K	5yr Biomass Ratio B_{t+5}/B_{MSY}	20yr Biomass Ratio B_{t+20}/B_{MSY}
30/15%	45 000	0.14	0.12	0.60	0.57	0.37	0.35	0.99	0.94
30/15%	40 000	0.12	0.14	0.55	0.56	0.38	0.35	0.99	0.94
30/15%	35 000	0.08	0.12	0.51	0.56	0.39	0.35	1.03	0.93
30/15%	30 000	0.05	0.12	0.43	0.56	0.41	0.35	1.08	0.92
30/15%	25 000	0.02	0.12	0.33	0.55	0.44	0.36	1.16	0.95
30/15%	20 000	0.01	0.12	0.24	0.56	0.48	0.35	1.29	0.93
30/15%	15 000	0.00	0.13	0.14	0.58	0.56	0.35	1.46	0.93
10/5%	45 000	0.27	0.18	0.71	0.63	0.29	0.32	0.78	0.85
10/5%	40 000	0.21	0.19	0.65	0.62	0.32	0.32	0.84	0.85
10/5%	35 000	0.14	0.19	0.59	0.62	0.35	0.32	0.94	0.85
10/5%	30 000	0.08	0.19	0.50	0.61	0.39	0.32	1.04	0.85
10/5%	25 000	0.04	0.18	0.37	0.59	0.44	0.33	1.16	0.88
10/5%	20 000	0.01	0.15	0.25	0.56	0.51	0.34	1.34	0.91
10/5%	15 000	0.01	0.07	0.15	0.48	0.59	0.38	1.54	0.99

(c) Fishing Industry Measures

Management Response for Ref. Pts	Test Fishing Nights	5yr Catch (t)	20yr Catch (t)	5yr Catch Variation	20yr Catch Variation	5yr Fishing Nights	20yr Fishing Nights	5yr CPUE (kg/boat day)	20yr CPUE (kg/boat day)	5yr No. Limit Triggers	20yr No. Limit Triggers	5yr No. Upper Triggers	20yr No. Upper Triggers
30/15%	45 000	2663	2957	0.17	0.26	29 161	25 357	88	84	1.6	3.4	0.4	3.7
30/15%	40 000	2714	2978	0.17	0.25	27 999	25 920	89	85	1.3	3.0	0.6	3.7
30/15%	35 000	2758	2992	0.17	0.25	28 174	26 083	91	85	1.1	2.8	0.9	3.9
30/15%	30 000	2748	3002	0.18	0.25	27 772	25 710	95	85	0.9	2.5	1.3	4.5
30/15%	25 000	2732	3013	0.20	0.26	26 615	25 615	104	85	0.7	2.4	1.8	5.2
30/15%	20 000	2596	3003	0.23	0.26	22 999	24 486	114	85	0.6	2.2	2.4	6.3
30/15%	15 000	2410	2998	0.26	0.29	18 364	24 287	131	85	0.6	2.0	3.0	7.6
10/5%	45 000	2819	2966	0.14	0.21	36 449	29 295	69	76	2.3	5.2	0.1	1.5
10/5%	40 000	2867	2992	0.13	0.21	35 999	29 159	75	76	1.7	4.2	0.2	1.8
10/5%	35 000	2865	3029	0.14	0.20	31 500	29 536	83	76	1.3	3.2	0.5	2.5
10/5%	30 000	2823	3049	0.15	0.20	28 350	29 536	93	77	1.0	2.5	0.9	3.8
10/5%	25 000	2742	3070	0.16	0.21	24 999	28 940	105	77	0.8	1.8	1.6	5.9
10/5%	20 000	2588	3059	0.17	0.22	20 837	28 142	120	81	0.7	1.3	2.3	8.7
10/5%	15 000	2321	2978	0.19	0.24	16 409	26 729	141	90	0.6	0.9	2.9	11.9

APPENDICES

Table 15.1.1.7 Performance of the fishing mortality reference points and status quo fishing (34 800 nights) measured against different biological and fishing industry objectives. Table (a) outlines the simulation details, Table (b) summaries the overfishing probabilities and expected median population sizes; the shaded cells indicated scenarios where 5-year biomass ratios B_{t+5}/B_{MSY} , are above one, and Table (c) summaries the expected median catch statistics and mean number of triggered reference points; the shaded cells highlight the scenarios that result in the best catches, lowest catch variation, highest fishing effort and catch rates, and the lowest number of catch-rate triggers.

(a) Simulation Details

Trawl Sector: Eastern King Prawn; **Model:** Monthly Delay Difference; **Recruitment Models:** Beverton-Holt.
Reference Points: Fishing at E_{MSY} , Fishing at $3/4E_{MSY}$ and Fishing at $2/3E_{MSY}$; Status quo – 34 800 fishing nights and no reference points.
Management Response to Triggered Reference Points: Stock assessment ever second year with fishing effort adjusted as required; Only for E_{MSY} , $3/4 E_{MSY}$ and $2/3E_{MSY}$.

(b) Biological Measures

Test Fishing Effort	5yr	20yr	5yr	20yr	5yr	20yr	5yr	20yr
	Probability $B_{t+5} < 20\%K$	Probability $B_{t+20} < 20\%K$	Probability $B_{t+5} < B_{MSY}$	Probability $B_{t+20} < B_{MSY}$	Biomass Ratio B_{t+5}/K	Biomass Ratio B_{t+20}/K	Biomass Ratio B_{t+5}/B_{MSY}	Biomass Ratio B_{t+20}/B_{MSY}
E_{MSY}	0.30	0.58	0.64	0.80	0.27	0.15	0.69	0.40
$3/4E_{MSY}$	0.20	0.27	0.51	0.55	0.38	0.34	1.02	0.91
$2/3E_{MSY}$	0.16	0.19	0.47	0.44	0.42	0.40	1.12	1.11
34 800	0.18	0.29	0.62	0.71	0.33	0.28	0.87	0.74

(c) Fishing Industry Measures

Test Fishing Nights	5yr	20yr	5yr	20yr	5yr	20yr
	Catch (t)	Catch (t)	Catch Variation	Catch Variation	CPUE (kg/boat day)	CPUE (kg/boat day)
E_{MSY}	2955	2723	0.18	0.26	63	37
$3/4E_{MSY}$	2785	3162	0.18	0.23	89	78
$2/3E_{MSY}$	2696	3186	0.18	0.23	97	92
34 800	2912	3011	0.13	0.19	76	64

Table 15.1.1.8 Performance of the 60% CPUE reference points and one-way management responses measured against different biological and fishing industry objectives. Table (a) outlines the simulation details, Table (b) summaries the overfishing probabilities and expected median population sizes; the shaded cells indicated scenarios where 5-year biomass ratios B_{t+5}/B_{MSY} , are above one, and Table (c) summaries the expected median catch statistics and mean number of triggered reference points; the shaded cells highlight the scenarios that result in the best catches, lowest catch variation, highest fishing effort and catch rates, and the lowest number of catch-rate triggers.

(a) Simulation Details

Trawl Sector: Eastern King Prawns; **Model:** Surplus Production Model - Schaefer; **Reference Points:** Limit - 60% CPUE; Upper - None.
Management Response to Triggered Reference Points: 10% – reduce fishing effort by 10%; 30% – reduce fishing effort by 30%;

(b) Biological Measures

Management Response for Ref. Pts	Test Fishing Nights	5yr Probability $B_{t+5}<20\%K$	20yr Probability $B_{t+20}<20\%K$	5yr Probability $B_{t+5}<B_{MSY}$	20yr Probability $B_{t+20}<B_{MSY}$	5yr Biomass Ratio B_{t+5}/K	20yr Biomass Ratio B_{t+20}/K	5yr Biomass Ratio B_{t+5}/B_{MSY}	20yr Biomass Ratio B_{t+20}/B_{MSY}
30%	45 000	0.00	0.00	0.39	0.22	0.54	0.55	1.07	1.11
30%	40 000	0.00	0.00	0.24	0.42	0.53	0.53	1.07	1.05
30%	35 000	0.00	0.00	0.04	0.36	0.59	0.52	1.18	1.04
30%	30 000	0.00	0.00	0.01	0.09	0.64	0.58	1.29	1.16
30%	25 000	0.00	0.00	0.02	0.01	0.69	0.65	1.37	1.30
30%	20 000	0.00	0.00	0.03	0.00	0.71	0.73	1.42	1.46
30%	15 000	0.00	0.01	0.03	0.01	0.72	0.83	1.44	1.66
10%	45 000	0.00	0.00	0.55	0.74	0.49	0.47	0.99	0.94
10%	40 000	0.00	0.00	0.24	0.69	0.53	0.47	1.06	0.95
10%	35 000	0.00	0.00	0.04	0.39	0.59	0.51	1.18	1.03
10%	30 000	0.00	0.00	0.01	0.09	0.64	0.58	1.28	1.16
10%	25 000	0.00	0.00	0.01	0.01	0.69	0.65	1.37	1.30
10%	20 000	0.00	0.00	0.03	0.00	0.71	0.73	1.43	1.46
10%	15 000	0.00	0.00	0.02	0.00	0.72	0.83	1.44	1.66

(c) Fishing Industry Measures

Management Response for Ref. Pts	Test Fishing Nights	5yr Catch (t)	20yr Catch (t)	5yr Catch Variation	20yr Catch Variation	5yr Fishing Nights	20yr Fishing Nights	5yr CPUE (kg/boat day)	20yr CPUE (kg/boat day)	5yr No. Limit Triggers	20yr No. Limit Triggers
30%	45 000	2633	2559	0.15	0.08	44 044	31 394	62	82	0.5	1.1
30%	40 000	2639	2600	0.07	0.04	39 972	38 747	65	72	0.0	0.6
30%	35 000	2527	2564	0.02	0.01	34 981	34 885	72	75	0.0	0.1
30%	30 000	2341	2439	0.03	0.03	30 027	29 981	79	85	0.0	0.0
30%	25 000	2095	2232	0.08	0.06	25 017	24 985	84	95	0.0	0.0
30%	20 000	1777	1938	0.17	0.09	20 021	19 996	86	107	0.0	0.0
30%	15 000	1398	1560	0.26	0.15	14 984	14 983	88	121	0.0	0.1
10%	45 000	2672	2615	0.15	0.07	44 023	37 185	60	68	0.5	1.8
10%	40 000	2640	2614	0.07	0.03	39 943	38 853	65	69	0.0	0.7
10%	35 000	2527	2567	0.02	0.01	34 988	34 918	72	75	0.0	0.1
10%	30 000	2340	2439	0.03	0.03	29 995	30 002	79	85	0.0	0.0
10%	25 000	2093	2232	0.08	0.06	25 013	24 980	84	95	0.0	0.0
10%	20 000	1775	1940	0.15	0.09	20 016	20 002	86	107	0.0	0.0
10%	15 000	1397	1562	0.21	0.16	14 988	14 986	88	121	0.0	0.1

Table 15.1.1.9 Performance of the 70% CPUE reference points and one-way management responses measured against different biological and fishing industry objectives. Table (a) outlines the simulation details, Table (b) summaries the overfishing probabilities and expected median population sizes; the shaded cells indicated scenarios where 5-year biomass ratios B_{t+5}/B_{MSY} , are above one, and Table (c) summaries the expected median catch statistics and mean number of triggered reference points; the shaded cells highlight the scenarios that result in the best catches, lowest catch variation, highest fishing effort and catch rates, and the lowest number of catch-rate triggers.

(a) Simulation Details

Trawl Sector: Eastern King Prawns; **Model:** Surplus Production Model - Schaefer; **Reference Points:** Limit - 70% CPUE; Upper – None.
Management Response to Triggered Reference Points: 10% – reduce fishing effort by 10%; 30% – reduce fishing effort by 30%.

(b) Biological Measures

Management Response for Ref. Pts	Test Fishing Nights	5yr Probability $B_{t+5} < 20\%K$	20yr Probability $B_{t+20} < 20\%K$	5yr Probability $B_{t+5} < B_{MSY}$	20yr Probability $B_{t+20} < B_{MSY}$	5yr Biomass Ratio B_{t+5}/K	20yr Biomass Ratio B_{t+20}/K	5yr Biomass Ratio B_{t+5}/B_{MSY}	20yr Biomass Ratio B_{t+20}/B_{MSY}
30%	45 000	0.00	0.00	0.06	0.03	0.67	0.63	1.35	1.26
30%	40 000	0.00	0.00	0.15	0.04	0.56	0.62	1.12	1.23
30%	35 000	0.00	0.00	0.04	0.13	0.59	0.59	1.18	1.19
30%	30 000	0.00	0.00	0.01	0.06	0.64	0.59	1.29	1.18
30%	25 000	0.00	0.00	0.01	0.01	0.69	0.65	1.37	1.30
30%	20 000	0.00	0.00	0.02	0.00	0.71	0.74	1.42	1.47
30%	15 000	0.00	0.01	0.03	0.02	0.72	0.84	1.43	1.67
10%	45 000	0.00	0.00	0.20	0.24	0.54	0.53	1.08	1.07
10%	40 000	0.00	0.00	0.17	0.22	0.54	0.53	1.09	1.07
10%	35 000	0.00	0.00	0.04	0.20	0.59	0.54	1.18	1.08
10%	30 000	0.00	0.00	0.01	0.07	0.64	0.58	1.29	1.17
10%	25 000	0.00	0.00	0.01	0.01	0.69	0.65	1.37	1.31
10%	20 000	0.00	0.00	0.03	0.00	0.71	0.73	1.42	1.46
10%	15 000	0.00	0.00	0.03	0.01	0.71	0.83	1.43	1.66

(c) Fishing Industry Measures

Management Response for Ref. Pts	Test Fishing Nights	5yr Catch (t)	20yr Catch (t)	5yr Catch Variation	20yr Catch Variation	5yr Fishing Nights	20yr Fishing Nights	5yr CPUE (kg/boat day)	20yr CPUE (kg/boat day)	5yr No. Limit Triggers	20yr No. Limit Triggers
30%	45 000	2414	2361	0.22	0.11	30 902	22 968	80	90	1.4	1.5
30%	40 000	2594	2490	0.08	0.05	39 437	27 852	67	90	0.4	1.2
30%	35 000	2527	2529	0.02	0.01	35 032	25 471	72	82	0.0	0.7
30%	30 000	2342	2434	0.03	0.03	30 010	29 942	79	85	0.0	0.1
30%	25 000	2090	2227	0.08	0.06	24 983	24 993	84	95	0.0	0.0
30%	20 000	1774	1932	0.18	0.09	20 002	19 988	87	107	0.0	0.1
30%	15 000	1396	1555	0.25	0.15	14 982	14 978	88	121	0.0	0.2
10%	45 000	2622	2594	0.16	0.07	39 749	32 940	66	78	1.4	3.0
10%	40 000	2624	2594	0.07	0.04	39 432	32 645	67	78	0.4	1.9
10%	35 000	2527	2556	0.02	0.01	34 970	33 021	72	79	0.0	0.8
10%	30 000	2343	2438	0.03	0.03	30 006	29 922	79	85	0.0	0.1
10%	25 000	2091	2230	0.08	0.06	24 978	24 971	84	95	0.0	0.0
10%	20 000	1774	1937	0.15	0.09	19 990	19 997	87	107	0.0	0.1
10%	15 000	1398	1557	0.20	0.15	14 976	14 961	88	121	0.0	0.2

Table 15.1.1.10 Performance of the 80% CPUE reference points and one-way management responses measured against different biological and fishing industry objectives. Table (a) outlines the simulation details, Table (b) summaries the overfishing probabilities and expected median population sizes; the shaded cells indicated scenarios where 5-year biomass ratios B_{t+5}/B_{MSY} , are above one, and Table (c) summaries the expected median catch statistics and mean number of triggered reference points; the shaded cells highlight the scenarios that result in the best catches, lowest catch variation, highest fishing effort and catch rates, and the lowest number of catch-rate triggers.

(a) Simulation details.

Trawl Sector: Eastern King Prawns; **Model:** Surplus Production Model - Schaefer; **Reference Points:** Limit - 80% CPUE; Upper - None.
Management Response to Triggered Reference Points: 10% – reduce fishing effort by 10%; 30% – reduce fishing effort by 30%.

(b) Biological Measures.

Management Response for Ref. Pts	Test Fishing Nights	5yr Probability $B_{t+5}<20\%K$	20yr Probability $B_{t+20}<20\%K$	5yr Probability $B_{t+5}<B_{MSY}$	20yr Probability $B_{t+20}<B_{MSY}$	5yr Biomass Ratio B_{t+5}/K	20yr Biomass Ratio B_{t+20}/K	5yr Biomass Ratio B_{t+5}/B_{MSY}	20yr Biomass Ratio B_{t+20}/B_{MSY}
30%	45 000	0.00	0.00	0.00	0.01	0.78	0.70	1.57	1.39
30%	40 000	0.00	0.00	0.03	0.01	0.69	0.68	1.38	1.36
30%	35 000	0.00	0.00	0.03	0.01	0.61	0.67	1.21	1.35
30%	30 000	0.00	0.00	0.01	0.01	0.64	0.66	1.29	1.31
30%	25 000	0.00	0.00	0.01	0.01	0.69	0.70	1.38	1.40
30%	20 000	0.00	0.00	0.02	0.01	0.71	0.75	1.43	1.50
30%	15 000	0.00	0.01	0.01	0.02	0.71	0.84	1.43	1.67
10%	45 000	0.00	0.00	0.04	0.03	0.58	0.60	1.16	1.20
10%	40 000	0.00	0.00	0.04	0.02	0.59	0.60	1.18	1.20
10%	35 000	0.00	0.00	0.03	0.02	0.60	0.60	1.19	1.20
10%	30 000	0.00	0.00	0.01	0.02	0.64	0.61	1.28	1.22
10%	25 000	0.00	0.00	0.01	0.01	0.69	0.66	1.37	1.32
10%	20 000	0.00	0.00	0.02	0.00	0.71	0.74	1.43	1.48
10%	15 000	0.00	0.00	0.02	0.01	0.72	0.84	1.44	1.68

(c) Fishing Industry Measures

Management Response for Ref. Pts	Test Fishing Nights	5yr Catch (t)	20yr Catch (t)	5yr Catch Variation	20yr Catch Variation	5yr Fishing Nights	20yr Fishing Nights	5yr CPUE (kg/boat day)	20yr CPUE (kg/boat day)	5yr No. Limit Triggers	20yr No. Limit Triggers
30%	45 000	2267	2152	0.28	0.14	22 054	21 995	96	101	2.0	2.1
30%	40 000	2322	2213	0.17	0.09	27 539	19 934	83	98	1.4	1.7
30%	35 000	2494	2352	0.02	0.04	34 650	24 295	73	98	0.4	1.2
30%	30 000	2340	2377	0.03	0.02	29 949	21 598	79	92	0.0	0.7
30%	25 000	2090	2230	0.08	0.05	24 992	24 890	84	96	0.0	0.2
30%	20 000	1771	1917	0.17	0.09	19 990	19 902	87	107	0.1	0.3
30%	15 000	1391	1540	0.24	0.14	14 963	14 915	89	121	0.1	0.6
10%	45 000	2559	2511	0.17	0.08	33 710	29 020	71	87	2.7	4.5
10%	40 000	2553	2508	0.09	0.04	35 082	28 888	72	87	1.6	3.4
10%	35 000	2510	2497	0.02	0.01	34 655	28 381	73	88	0.4	2.1
10%	30 000	2342	2417	0.03	0.03	29 989	27 635	79	88	0.1	0.8
10%	25 000	2093	2226	0.08	0.06	24 975	24 906	84	96	0.0	0.2
10%	20 000	1773	1929	0.15	0.09	19 982	19 900	87	107	0.1	0.3
10%	15 000	1394	1545	0.20	0.15	14 954	14 919	88	122	0.1	0.6

Table 15.1.11 Performance of the 60% CPUE reference points and two-way management responses measured against different biological and fishing industry objectives. Table (a) outlines the simulation details, Table (b) summaries the overfishing probabilities and expected median population sizes; the shaded cells indicated scenarios where 5-year biomass ratios B_{t+5}/B_{MSY} , are above one, and Table (c) summaries the expected median catch statistics and mean number of triggered reference points; the shaded cells highlight the scenarios that result in the best catches, lowest catch variation, highest fishing effort and catch rates, and the lowest number of catch-rate triggers.

(a) Simulation Details

Trawl Sector: Eastern King Prawns; **Model:** Surplus Production - Schaefer; **Reference Points:** Limit - 60% CPUE; Upper – 95% percentile.
Management Response to Triggered Reference Points: 10/5% – reduce fishing effort by 10% or increase by 5%; 30/15% – reduce fishing effort by 30% or increase by 15%.

(b) Biological Measures

Management Response for Ref. Pts	Test Fishing Nights	5yr Probability $B_{t+5} < 20\%K$	20yr Probability $B_{t+20} < 20\%K$	5yr Probability $B_{t+5} < B_{MSY}$	20yr Probability $B_{t+20} < B_{MSY}$	5yr Biomass Ratio B_{t+5}/K	20yr Biomass Ratio B_{t+20}/K	5yr Biomass Ratio B_{t+5}/B_{MSY}	20yr Biomass Ratio B_{t+20}/B_{MSY}
30/15%	45 000	0.00	0.00	0.39	0.22	0.53	0.55	1.07	1.11
30/15%	40 000	0.00	0.00	0.23	0.41	0.53	0.52	1.07	1.05
30/15%	35 000	0.00	0.00	0.04	0.36	0.59	0.52	1.18	1.04
30/15%	30 000	0.00	0.00	0.01	0.08	0.64	0.58	1.29	1.16
30/15%	25 000	0.00	0.00	0.01	0.01	0.69	0.65	1.37	1.30
30/15%	20 000	0.00	0.00	0.03	0.00	0.68	0.68	1.36	1.36
30/15%	15 000	0.00	0.01	0.02	0.01	0.65	0.70	1.30	1.40
10/5%	45 000	0.00	0.00	0.54	0.74	0.49	0.47	0.99	0.94
10/5%	40 000	0.00	0.00	0.24	0.69	0.53	0.47	1.06	0.95
10/5%	35 000	0.00	0.00	0.04	0.40	0.59	0.51	1.18	1.03
10/5%	30 000	0.00	0.00	0.01	0.09	0.64	0.58	1.29	1.16
10/5%	25 000	0.00	0.00	0.01	0.01	0.68	0.65	1.37	1.30
10/5%	20 000	0.00	0.00	0.03	0.00	0.70	0.72	1.41	1.44
10/5%	15 000	0.00	0.00	0.03	0.00	0.69	0.76	1.38	1.52

(c) Fishing Industry Measures

Management Response for Ref. Pts	Test Fishing Nights	5yr Catch (t)	20yr Catch (t)	5yr Catch Variation	20yr Catch Variation	5yr Fishing Nights	20yr Fishing Nights	5yr CPUE (kg/boat day)	20yr CPUE (kg/boat day)	5yr No. Limit Triggers	20yr No. Limit Triggers	5yr No. Upper Triggers	20yr No. Upper Triggers
30/15%	45 000	2633	2563	0.15	0.07	44 079	31 436	63	82	0.5	1.1	0.0	0.1
30/15%	40 000	2636	2600	0.08	0.04	39 931	38 653	65	72	0.1	0.6	0.0	0.0
30/15%	35 000	2529	2565	0.02	0.01	34 995	34 916	72	75	0.0	0.1	0.0	0.0
30/15%	30 000	2342	2439	0.03	0.03	29 996	29 993	79	85	0.0	0.0	0.0	0.0
30/15%	25 000	2095	2239	0.08	0.06	25 055	25 049	84	94	0.0	0.0	0.1	0.2
30/15%	20 000	1902	2099	0.18	0.10	22 952	23 016	84	99	0.0	0.1	1.0	1.3
30/15%	15 000	1595	2352	0.26	0.15	19 722	22 402	80	105	0.1	0.2	1.9	2.9
10/5%	45 000	2670	2614	0.15	0.07	44 017	37 223	60	68	0.5	1.8	0.0	0.0
10/5%	40 000	2643	2616	0.07	0.03	39 946	38 745	65	68	0.0	0.7	0.0	0.0
10/5%	35 000	2529	2567	0.02	0.01	35 003	34 892	73	75	0.0	0.1	0.0	0.0
10/5%	30 000	2344	2439	0.03	0.03	29 995	29 976	79	85	0.0	0.0	0.0	0.0
10/5%	25 000	2093	2231	0.08	0.06	25 034	24 986	84	95	0.0	0.0	0.0	0.0
10/5%	20 000	1801	1978	0.14	0.09	20 548	20 550	86	104	0.0	0.0	0.7	1.0
10/5%	15 000	1466	1728	0.21	0.14	16 408	17 978	85	112	0.0	0.1	1.7	3.8

Table 15.1.1.12 Performance of the 70% CPUE reference points and two-way management responses measured against different biological and fishing industry objectives. Table (a) outlines the simulation details, Table (b) summaries the overfishing probabilities and expected median population sizes; the shaded cells indicated scenarios where 5-year biomass ratios B_{t+5}/B_{MSY} , are above one, and Table (c) summaries the expected median catch statistics and mean number of triggered reference points; the shaded cells highlight the scenarios that result in the best catches, lowest catch variation, highest fishing effort and catch rates, and the lowest number of catch-rate triggers.

(a) Simulation Details

Trawl Sector: Eastern King Prawns; **Model:** Surplus Production - Schaefer; **Reference Points:** Limit - 70% CPUE; Upper – 95% percentile.
Management Response to Triggered Reference Points: 10/5% – reduce fishing effort by 10% or increase by 5%; 30/15% – reduce fishing effort by 30% or increase by 15%.

(b) Biological Measures

Management Response for Ref. Pts	Test Fishing Nights	5yr Probability $B_{t+5} < 20\%K$	20yr Probability $B_{t+20} < 20\%K$	5yr Probability $B_{t+5} > B_{MSY}$	20yr Probability $B_{t+20} < B_{MSY}$	5yr Biomass Ratio B_{t+5}/K	20yr Biomass Ratio B_{t+20}/K	5yr Biomass Ratio B_{t+5}/B_{MSY}	20yr Biomass Ratio B_{t+20}/B_{MSY}
30/15%	45 000	0.00	0.00	0.07	0.04	0.67	0.62	1.34	1.25
30/15%	40 000	0.00	0.00	0.15	0.05	0.56	0.62	1.12	1.23
30/15%	35 000	0.00	0.00	0.04	0.12	0.59	0.59	1.18	1.18
30/15%	30 000	0.00	0.00	0.01	0.06	0.64	0.59	1.29	1.18
30/15%	25 000	0.00	0.00	0.01	0.01	0.69	0.65	1.38	1.30
30/15%	20 000	0.00	0.00	0.03	0.01	0.69	0.68	1.38	1.36
30/15%	15 000	0.00	0.01	0.03	0.01	0.66	0.70	1.32	1.40
10/5%	45 000	0.00	0.00	0.21	0.23	0.54	0.53	1.09	1.07
10/5%	40 000	0.00	0.00	0.18	0.22	0.54	0.53	1.08	1.07
10/5%	35 000	0.00	0.00	0.03	0.20	0.59	0.54	1.18	1.08
10/5%	30 000	0.00	0.00	0.01	0.07	0.64	0.58	1.29	1.17
10/5%	25 000	0.00	0.00	0.02	0.01	0.69	0.65	1.37	1.30
10/5%	20 000	0.00	0.00	0.03	0.00	0.69	0.70	1.39	1.40
10/5%	15 000	0.00	0.00	0.03	0.01	0.69	0.75	1.38	1.49

(c) Fishing Industry Measures

Management Response for Ref. Pts	Test Fishing Nights	5yr Catch (t)	20yr Catch (t)	5yr Catch Variation	20yr Catch Variation	5yr Fishing Nights	20yr Fishing Nights	5yr CPUE (kg/boat day)	20yr CPUE (kg/boat day)	5yr No. Limit Triggers	20yr No. Limit Triggers	5yr No. Upper Triggers	20yr No. Upper Triggers
30/15%	45 000	2418	2369	0.22	0.11	30 919	25 710	79	90	1.4	1.6	0.1	0.3
30/15%	40 000	2594	2497	0.08	0.05	39 518	27 885	67	90	0.4	1.2	0.0	0.1
30/15%	35 000	2524	2530	0.02	0.01	34 959	26 002	73	81	0.0	0.7	0.0	0.1
30/15%	30 000	2342	2432	0.03	0.03	29 998	29 926	79	85	0.0	0.1	0.0	0.0
30/15%	25 000	2092	2233	0.08	0.06	25 039	25 047	84	95	0.0	0.1	0.1	0.3
30/15%	20 000	1890	2074	0.18	0.10	22 812	22 829	84	100	0.1	0.3	1.0	1.5
30/15%	15 000	1590	1926	0.25	0.15	19 634	21 620	81	103	0.1	0.4	1.9	3.2
10/5%	45 000	2622	2593	0.16	0.07	39 799	32 967	66	78	1.4	3.0	0.0	0.0
10/5%	40 000	2627	2596	0.08	0.04	39 507	32 704	67	78	0.4	1.9	0.0	0.0
10/5%	35 000	2527	2557	0.02	0.01	34 958	32 943	72	78	0.0	0.8	0.0	0.0
10/5%	30 000	2344	2438	0.03	0.03	30 016	29 899	79	85	0.0	0.1	0.0	0.0
10/5%	25 000	2093	2234	0.08	0.06	25 096	25 042	84	95	0.0	0.1	0.1	0.2
10/5%	20 000	1820	2013	0.15	0.09	21 176	21 360	84	102	0.0	0.1	1.2	1.8
10/5%	15 000	1464	1764	0.21	0.15	16 470	18 937	85	110	0.1	0.2	1.9	5.1

Table 15.1.1.13 Performance of the 80% CPUE reference points and two-way management responses measured against different biological and fishing industry objectives. Table (a) outlines the simulation details, Table (b) summaries the overfishing probabilities and expected median population sizes; the shaded cells indicated scenarios where 5-year biomass ratios B_{t+5}/B_{MSY} , are above one, and Table (c) summaries the expected median catch statistics and mean number of triggered reference points; the shaded cells highlight the scenarios that result in the best catches, lowest catch variation, highest fishing effort and catch rates, and the lowest number of catch-rate triggers.

(a) Simulation Details

Trawl Sector: Eastern King Prawns; **Model:** Surplus Production – Schaefer; **Reference Points:** Limit - 80% CPUE; Upper – 95% percentile.
Management Response to Triggered Reference Points: 10/5% – reduce fishing effort by 10% or increase by 5%; 30/15% – reduce fishing effort by 30% or increase by 15%.

(b) Biological Measures

Management Response for Ref. Pts	Test Fishing Nights	5yr Probability $B_{t+5} < 20\%K$	20yr Probability $B_{t+20} < 20\%K$	5yr Probability $B_{t+5} < B_{MSY}$	20yr Probability $B_{t+20} < B_{MSY}$	5yr Biomass Ratio B_{t+5}/K	20yr Biomass Ratio B_{t+20}/K	5yr Biomass Ratio B_{t+5}/B_{MSY}	20yr Biomass Ratio B_{t+20}/B_{MSY}
30/15%	45 000	0.00	0.00	0.00	0.01	0.78	0.69	1.57	1.39
30/15%	40 000	0.00	0.00	0.02	0.01	0.70	0.68	1.40	1.35
30/15%	35 000	0.00	0.00	0.03	0.01	0.61	0.67	1.21	1.34
30/15%	30 000	0.00	0.00	0.01	0.01	0.65	0.66	1.29	1.32
30/15%	25 000	0.00	0.00	0.01	0.01	0.69	0.67	1.39	1.34
30/15%	20 000	0.00	0.01	0.02	0.01	0.71	0.73	1.41	1.46
30/15%	15 000	0.00	0.01	0.02	0.02	0.67	0.78	1.34	1.56
10/5%	45 000	0.00	0.00	0.04	0.02	0.58	0.60	1.16	1.20
10/5%	40 000	0.00	0.00	0.05	0.02	0.59	0.60	1.18	1.20
10/5%	35 000	0.00	0.00	0.03	0.02	0.59	0.60	1.19	1.20
10/5%	30 000	0.00	0.00	0.01	0.02	0.64	0.61	1.28	1.22
10/5%	25 000	0.00	0.00	0.01	0.01	0.69	0.65	1.37	1.31
10/5%	20 000	0.00	0.00	0.02	0.00	0.70	0.71	1.40	1.42
10/5%	15 000	0.00	0.00	0.02	0.01	0.69	0.76	1.38	1.52

(c) Fishing Industry Measures

Management Response for Ref. Pts	Test Fishing Nights	5yr Catch (t)	20yr Catch (t)	5yr Catch Variation	20yr Catch Variation	5yr Fishing Nights	20yr Fishing Nights	5yr CPUE (kg/boat day)	20yr CPUE (kg/boat day)	5yr No. Limit Triggers	20yr No. Limit Triggers	5yr No. Upper Triggers	20yr No. Upper Triggers
30/15%	45 000	2270	2159	0.28	0.14	22 181	22 050	96	101	2.0	2.3	0.1	0.6
30/15%	40 000	2324	2237	0.17	0.09	27 441	22 232	83	97	1.4	1.8	0.1	0.5
30/15%	35 000	2490	2355	0.02	0.04	34 663	24 322	73	98	0.4	1.3	0.0	0.3
30/15%	30 000	2343	2380	0.03	0.02	29 964	21 806	79	92	0.0	0.8	0.0	0.2
30/15%	25 000	2090	2375	0.08	0.06	24 970	24 892	84	95	0.1	0.3	0.1	0.4
30/15%	20 000	1864	2191	0.17	0.10	21 996	21 177	87	103	0.2	0.6	0.9	1.8
30/15%	15 000	1572	2197	0.24	0.14	19 468	19 828	84	111	0.3	0.9	1.8	3.8
10/5%	45 000	2556	2509	0.17	0.08	33 654	28 939	71	87	2.7	4.5	0.0	0.0
10/5%	40 000	2553	2509	0.09	0.04	35 185	28 767	72	88	1.6	3.4	0.0	0.0
10/5%	35 000	2513	2498	0.02	0.01	34 667	28 371	73	88	0.4	2.1	0.0	0.0
10/5%	30 000	2343	2419	0.03	0.03	29 978	27 625	79	89	0.0	0.8	0.0	0.0
10/5%	25 000	2091	2226	0.08	0.06	24 991	24 909	84	95	0.1	0.3	0.1	0.2
10/5%	20 000	1817	2000	0.15	0.09	20 984	20 986	85	103	0.1	0.4	1.1	1.9
10/5%	15 000	1461	1742	0.20	0.15	16 419	18 173	85	111	0.2	0.6	1.9	5.2

15.1.2 Torres Strait Tiger Prawns

Table 15.1.2.1 Performance of status quo (no) management responses measured against different biological and fishing industry objectives. Table (a) outlines the simulation details, Table (b) summaries the overfishing probabilities and expected median population sizes; the shaded cells indicated scenarios where 5-year biomass ratios B_{t+5}/B_{MSY} are above one, and Table (c) summaries the expected median catch statistics and mean number of triggered reference points; the shaded cells highlight the scenarios that result in the best catches, lowest catch variation, highest fishing effort and catch rates, and the lowest number of catch-rate triggers.

(a) Simulation Details

Trawl Sector: Torres Strait Tiger Prawns; **Model:** Monthly Delay Difference; **Recruitment Models:** Ricker and Beverton-Holt.
Reference Points: None.
Management Response to Triggered Reference Points: None.

(b) Biological Measures

Recruitment Model	Test Fishing Effort	5yr Probability $B_{t+5} < 20\%K$	20yr Probability $B_{t+20} < 20\%K$	5yr Probability $B_{t+5} < B_{MSY}$	20yr Probability $B_{t+20} < B_{MSY}$	5yr Biomass Ratio B_{t+5}/K	20yr Biomass Ratio B_{t+20}/K	5yr Biomass Ratio B_{t+5}/B_{MSY}	20yr Biomass Ratio B_{t+20}/B_{MSY}
Ricker	11 000	0.23	0.51	0.78	0.94	0.28	0.20	0.76	0.53
Ricker	9 000	0.07	0.22	0.44	0.71	0.38	0.31	1.05	0.82
Ricker	7 000	0.02	0.08	0.18	0.37	0.48	0.41	1.31	1.10
Ricker	5 000	0.01	0.03	0.06	0.15	0.57	0.51	1.55	1.36
Ricker	4 000	0.00	0.01	0.01	0.04	0.66	0.61	1.77	1.62
BH	11 000	0.13	0.31	0.30	0.48	0.30	0.24	1.27	1.03
BH	9 000	0.03	0.08	0.11	0.21	0.39	0.33	1.64	1.39
BH	7 000	0.01	0.02	0.05	0.08	0.47	0.41	1.98	1.74
BH	5 000	0.00	0.01	0.01	0.03	0.55	0.49	2.32	2.09
BH	4 000	0.00	0.00	0.01	0.01	0.63	0.58	2.67	2.45

(c) Fishing Industry Measures

Recruitment Model	Test Fishing Nights	5yr Catch (t)	20yr Catch (t)	5yr Catch Variation	20yr Catch Variation	5yr CPUE (kg/boat day)	20yr CPUE (kg/boat day)	5yr No. Limit Triggers	20yr No. Limit Triggers	5yr No. Upper Triggers	20yr No. Upper Triggers
Ricker	11 000	650	561	0.37	0.54	41	34	2.0	11.8	0.1	0.1
Ricker	9 000	646	624	0.32	0.42	56	53	1.2	8.1	0.2	0.3
Ricker	7 000	607	623	0.29	0.35	71	71	0.7	4.9	0.4	0.9
Ricker	5 000	544	585	0.27	0.31	84	90	0.4	2.7	0.7	1.9
Ricker	4 000	462	512	0.25	0.28	96	106	0.2	1.5	1.0	3.2
BH	11 000	694	695	0.28	0.30	45	44	1.9	10.5	0.0	0.1
BH	9 000	657	679	0.27	0.29	58	59	1.1	6.8	0.2	0.3
BH	7 000	603	640	0.26	0.27	70	74	0.7	4.1	0.4	0.8
BH	5 000	533	580	0.26	0.27	83	90	0.3	2.3	0.6	1.7
BH	4 000	451	499	0.25	0.26	95	105	0.2	1.3	1.0	3.0

Table 15.1.2.2 Performance of the 70% CPUE reference points and heavy one-way management responses measured against different biological and fishing industry objectives. Table (a) outlines the simulation details, Table (b) summaries the overfishing probabilities and expected median population sizes; the shaded cells indicated scenarios where 5-year biomass ratios B_{t+5}/B_{MSY} , are above one, and Table (c) summaries the expected median catch statistics and mean number of triggered reference points; the shaded cells highlight the scenarios that result in the best catches, lowest catch variation, highest fishing effort and catch rates, and the lowest number of catch-rate triggers.

(a) Simulation details

Trawl Sector: Torres Strait; **Model:** Monthly Delay Difference; **Recruitment Models:** Ricker and Beverton-Holt; **Reference Points:** Limit 70% CPUE; Upper – None. **Management Response to Triggered Reference Points:** For Limit, reduce fishing effort by 30%; For Upper, no increase in fishing effort.

(b) Biological Measures

Recruitment Model	Test Fishing Effort	5yr Probability $B_{t+5} < 20\%K$	20yr Probability $B_{t+20} < 20\%K$	5yr Probability $B_{t+5} < B_{MSY}$	20yr Probability $B_{t+20} < B_{MSY}$	5yr Biomass Ratio B_{t+5}/K	20yr Biomass Ratio B_{t+20}/K	5yr Biomass Ratio B_{t+5}/B_{MSY}	20yr Biomass Ratio B_{t+20}/B_{MSY}
Ricker	11 000	0.02	0.00	0.46	0.28	0.37	0.48	1.02	1.28
Ricker	9 000	0.01	0.00	0.28	0.22	0.43	0.49	1.19	1.32
Ricker	7 000	0.00	0.00	0.12	0.11	0.50	0.51	1.37	1.39
Ricker	5 000	0.00	0.00	0.04	0.05	0.58	0.56	1.58	1.53
Ricker	4 000	0.00	0.00	0.01	0.01	0.66	0.63	1.80	1.73
BH	11 000	0.01	0.01	0.14	0.11	0.38	0.44	1.64	1.89
BH	9 000	0.00	0.00	0.06	0.07	0.43	0.46	1.83	1.94
BH	7 000	0.00	0.00	0.03	0.04	0.49	0.50	2.07	2.08
BH	5 000	0.00	0.00	0.01	0.02	0.56	0.54	2.37	2.27
BH	4 000	0.00	0.00	0.01	0.01	0.63	0.60	2.70	2.54

(c) Fishing Industry Measures

Recruitment Model	Test Fishing Nights	5yr Catch (t)	20yr Catch (t)	5yr Catch Variation	20yr Catch Variation	5yr Fishing Nights	20yr Fishing Nights	5yr CPUE (kg/boat day)	20yr CPUE (kg/boat day)	5yr No. Limit Triggers	20yr No. Limit Triggers	5yr No. Upper Triggers	20yr No. Upper Triggers
Ricker	11 000	567	580	0.47	0.49	9 447	6 616	55	83	1.6	2.6	0.1	0.1
Ricker	9 000	609	574	0.42	0.47	8 836	6 711	62	85	1.0	1.8	0.2	0.3
Ricker	7 000	599	587	0.36	0.44	7 361	6 436	72	88	0.6	1.3	0.4	0.9
Ricker	5 000	542	570	0.32	0.40	5 850	5 393	84	96	0.3	0.9	0.7	1.9
Ricker	4 000	461	508	0.28	0.36	4 423	4 244	96	108	0.2	0.6	1.0	3.2
BH	11 000	614	606	0.40	0.46	9 900	7 324	58	79	1.4	2.3	0.0	0.1
BH	9 000	622	598	0.37	0.44	8 911	7 231	64	83	0.8	1.6	0.2	0.3
BH	7 000	594	593	0.34	0.42	7 361	6 510	72	87	0.5	1.2	0.4	0.8
BH	5 000	530	564	0.31	0.39	5 852	5 413	83	95	0.3	0.8	0.6	1.7
BH	4 000	450	495	0.29	0.35	4 422	4 240	95	107	0.2	0.5	1.0	3.0

Table 15.1.2.3 Performance of the 70% CPUE reference points and moderate one-way management responses measured against different biological and fishing industry objectives. Table (a) outlines the simulation details, Table (b) summaries the overfishing probabilities and expected median population sizes; the shaded cells indicated scenarios where 5-year biomass ratios B_{t+5}/B_{MSY} , are above one, and Table (c) summaries the expected median catch statistics and mean number of triggered reference points; the shaded cells highlight the scenarios that result in the best catches, lowest catch variation, highest fishing effort and catch rates, and the lowest number of catch-rate triggers.

(a) Simulation Details

Trawl Sector: Torres Strait; **Model:** Monthly Delay Difference; **Recruitment Models:** Ricker and Beverton-Holt; **Reference Points:** Limit 70% CPUE; Upper – None. **Management Response to Triggered Reference Points:** For Limit, reduce fishing effort by 10%; For Upper, no increase in fishing effort.

(b) Biological Measures

Recruitment Model	Test Fishing Effort	5yr Probability $B_{t+5} < 20\%K$	20yr Probability $B_{t+20} < 20\%K$	5yr Probability $B_{t+5} < B_{MSY}$	20yr Probability $B_{t+20} < B_{MSY}$	5yr Biomass Ratio B_{t+5}/K	20yr Biomass Ratio B_{t+20}/K	5yr Biomass Ratio B_{t+5}/B_{MSY}	20yr Biomass Ratio B_{t+20}/B_{MSY}
Ricker	11 000	0.11	0.01	0.70	0.40	0.31	0.40	0.86	1.11
Ricker	9 000	0.03	0.00	0.37	0.29	0.40	0.44	1.10	1.19
Ricker	7 000	0.01	0.00	0.15	0.14	0.49	0.48	1.32	1.31
Ricker	5 000	0.00	0.00	0.05	0.06	0.57	0.54	1.56	1.48
Ricker	4 000	0.00	0.00	0.01	0.02	0.66	0.62	1.79	1.69
BH	11 000	0.05	0.01	0.21	0.15	0.33	0.38	1.40	1.65
BH	9 000	0.01	0.00	0.09	0.09	0.40	0.42	1.71	1.77
BH	7 000	0.00	0.00	0.04	0.05	0.48	0.46	2.01	1.97
BH	5 000	0.00	0.00	0.01	0.02	0.55	0.52	2.34	2.20
BH	4 000	0.00	0.00	0.01	0.01	0.63	0.59	2.67	2.50

(c) Fishing Industry Measures

Recruitment Model	Test Fishing Nights	5yr Catch (t)	20yr Catch (t)	5yr Catch Variation	20yr Catch Variation	5yr Fishing Nights	20yr Fishing Nights	5yr CPUE (kg/boat day)	20yr CPUE (kg/boat day)	5yr No. Limit Triggers	20yr No. Limit Triggers	5yr No. Upper Triggers	20yr No. Upper Triggers
Ricker	11 000	622	602	0.39	0.43	11 805	7 941	46	71	2.0	6.1	0.1	0.1
Ricker	9 000	639	604	0.35	0.42	9 584	7 771	58	76	1.2	4.1	0.2	0.3
Ricker	7 000	603	608	0.31	0.39	7 681	6 825	71	82	0.7	2.6	0.4	0.9
Ricker	5 000	542	575	0.28	0.36	5 963	5 569	84	92	0.4	1.6	0.7	1.9
Ricker	4 000	462	509	0.26	0.32	4 470	4 332	96	107	0.2	1.0	1.0	3.2
BH	11 000	669	638	0.31	0.39	11 922	8 613	49	70	1.8	5.3	0.0	0.1
BH	9 000	647	633	0.30	0.38	9 625	8 075	59	75	1.0	3.5	0.2	0.3
BH	7 000	598	617	0.29	0.36	7 686	6 886	71	81	0.6	2.2	0.4	0.8
BH	5 000	531	569	0.27	0.33	5 968	5 605	83	92	0.3	1.4	0.6	1.7
BH	4 000	451	496	0.26	0.31	4 470	4 335	95	105	0.2	0.8	1.0	3.0

Table 15.1.2.4 Performance of the 70% CPUE reference points and heavy two-way management responses measured against different biological and fishing industry objectives. Table (a) outlines the simulation details, Table (b) summaries the overfishing probabilities and expected median population sizes; the shaded cells indicated scenarios where 5-year biomass ratios B_{t+5}/B_{MSY} , are above one, and Table (c) summaries the expected median catch statistics and mean number of triggered reference points; the shaded cells highlight the scenarios that result in the best catches, lowest catch variation, highest fishing effort and catch rates, and the lowest number of catch-rate triggers.

(a) Simulation Details

Trawl Sector: Torres Strait; **Model:** Monthly Delay Difference; **Recruitment Models:** Ricker and Beverton-Holt; **Reference Points:** Limit 70% CPUE; Upper – 95 percentile. **Management Response to Triggered Reference Points:** For Limit, reduce fishing effort by 30%; For Upper, increase fishing effort by 15%.

(b) Biological Measures

Recruitment Model	Test Fishing Effort	5yr Probability $B_{t+5} < 20\%K$	20yr Probability $B_{t+20} < 20\%K$	5yr Probability $B_{t+5} < B_{MSY}$	20yr Probability $B_{t+20} < B_{MSY}$	5yr Biomass Ratio B_{t+5}/K	20yr Biomass Ratio B_{t+20}/K	5yr Biomass Ratio B_{t+5}/B_{MSY}	20yr Biomass Ratio B_{t+20}/B_{MSY}
Ricker	11 000	0.02	0.00	0.48	0.28	0.37	0.47	1.02	1.28
Ricker	9 000	0.01	0.00	0.29	0.25	0.42	0.47	1.17	1.30
Ricker	7 000	0.00	0.00	0.13	0.17	0.49	0.49	1.34	1.34
Ricker	5 000	0.00	0.00	0.05	0.11	0.56	0.53	1.53	1.43
Ricker	4 000	0.00	0.00	0.02	0.07	0.63	0.57	1.74	1.55
BH	11 000	0.01	0.01	0.14	0.11	0.38	0.44	1.64	1.88
BH	9 000	0.01	0.00	0.07	0.08	0.43	0.45	1.81	1.93
BH	7 000	0.00	0.00	0.04	0.05	0.48	0.48	2.02	2.01
BH	5 000	0.00	0.00	0.01	0.03	0.54	0.51	2.30	2.15
BH	4 000	0.00	0.00	0.01	0.02	0.61	0.55	2.58	2.31

(c) Fishing Industry Measures

Recruitment Model	Test Fishing Nights	5yr Catch (t)	20yr Catch (t)	5yr Catch Variation	20yr Catch Variation	5yr Fishing Nights	20yr Fishing Nights	5yr CPUE (kg/boat day)	20yr CPUE (kg/boat day)	5yr No. Limit Triggers	20yr No. Limit Triggers	5yr No. Upper Triggers	20yr No. Upper Triggers
Ricker	11 000	567	582	0.47	0.49	9 496	6 613	55	82	1.6	2.6	0.0	
Ricker	9 000	609	574	0.43	0.48	9 076	6 742	62	84	1.0	1.8	0.1	0.2
Ricker	7 000	603	588	0.39	0.47	7 691	6 753	71	87	0.6	1.3	0.3	0.4
Ricker	5 000	549	579	0.38	0.46	6 313	5 974	83	93	0.3	0.9	0.5	0.7
Ricker	4 000	473	524	0.38	0.47	4 959	5 010	95	100	0.2	0.6	0.9	1.3
BH	11 000	614	606	0.40	0.46	9 970	7 324	58	78	1.4	2.3	0.0	
BH	9 000	622	598	0.38	0.45	9 123	7 269	64	82	0.8	1.6	0.1	0.1
BH	7 000	598	598	0.36	0.44	7 677	6 821	72	86	0.5	1.2	0.3	0.3
BH	5 000	535	574	0.36	0.43	6 267	5 958	82	93	0.3	0.8	0.5	0.7
BH	4 000	460	509	0.38	0.45	4 939	4 914	94	100	0.2	0.5	0.8	1.2

Table 15.1.2.5 Performance of the 70% CPUE reference points and moderate two-way management responses measured against different biological and fishing industry objectives. Table (a) outlines the simulation details, Table (b) summaries the overfishing probabilities and expected median population sizes; the shaded cells indicated scenarios where 5-year biomass ratios B_{t+5}/B_{MSY} , are above one, and Table (c) summaries the expected median catch statistics and mean number of triggered reference points; the shaded cells highlight the scenarios that result in the best catches, lowest catch variation, highest fishing effort and catch rates, and the lowest number of catch-rate triggers.

(a) Simulation Details

Trawl Sector: Torres Strait; **Model:** Monthly Delay Difference; **Recruitment Models:** Ricker and Beverton-Holt; **Reference Points:** Limit 70% CPUE; Upper – 95 percentile. **Management Response to Triggered Reference Points:** For Limit, reduce fishing effort by 10%; For Upper, increase fishing effort by 5%.

(b) Biological Measures

Recruitment Model	Test Fishing Effort	5yr Probability $B_{t+5} < 20\%K$	20yr Probability $B_{t+20} < 20\%K$	5yr Probability $B_{t+5} < B_{MSY}$	20yr Probability $B_{t+20} < B_{MSY}$	5yr Biomass Ratio B_{t+5}/K	20yr Biomass Ratio B_{t+20}/K	5yr Biomass Ratio B_{t+5}/B_{MSY}	20yr Biomass Ratio B_{t+20}/B_{MSY}
Ricker	11 000	0.11	0.01	0.70	0.41	0.31	0.40	0.86	1.10
Ricker	9 000	0.03	0.00	0.37	0.30	0.40	0.43	1.09	1.17
Ricker	7 000	0.01	0.00	0.16	0.17	0.49	0.47	1.32	1.27
Ricker	5 000	0.00	0.00	0.05	0.08	0.57	0.52	1.54	1.41
Ricker	4 000	0.00	0.00	0.02	0.03	0.65	0.59	1.76	1.59
BH	11 000	0.05	0.01	0.22	0.15	0.33	0.38	1.40	1.65
BH	9 000	0.01	0.00	0.09	0.10	0.40	0.42	1.70	1.75
BH	7 000	0.00	0.00	0.04	0.06	0.48	0.46	1.99	1.92
BH	5 000	0.00	0.00	0.01	0.03	0.55	0.51	2.30	2.13
BH	4 000	0.00	0.00	0.01	0.01	0.62	0.57	2.63	2.36

(c) Fishing Industry Measures

Recruitment Model	Test Fishing Nights	5yr Catch (t)	20yr Catch (t)	5yr Catch Variation	20yr Catch Variation	5yr Fishing Nights	20yr Fishing Nights	5yr CPUE (kg/boat day)	20yr CPUE (kg/boat day)	5yr No. Limit Triggers	20yr No. Limit Triggers	5yr No. Upper Triggers	20yr No. Upper Triggers
Ricker	11 000	620	602	0.39	0.43	11 816	7 941	46	71	2.0	6.2	0.1	0.1
Ricker	9 000	639	604	0.35	0.43	9 659	7 856	58	75	1.2	4.1	0.2	0.2
Ricker	7 000	605	609	0.33	0.41	7 781	7 050	71	81	0.7	2.6	0.3	0.6
Ricker	5 000	546	578	0.31	0.40	6 164	5 960	84	91	0.4	1.6	0.6	1.2
Ricker	4 000	468	519	0.29	0.41	4 702	4 857	96	104	0.2	1.0	1.0	2.2
BH	11 000	669	638	0.31	0.39	11 936	8 617	49	69	1.8	5.3	0.0	0.0
BH	9 000	647	634	0.30	0.38	9 683	8 213	59	74	1.0	3.5	0.1	0.2
BH	7 000	600	617	0.30	0.37	7 779	7 087	70	81	0.6	2.2	0.3	0.5
BH	5 000	534	572	0.30	0.37	6 161	5 944	83	91	0.3	1.4	0.6	1.1
BH	4 000	455	504	0.30	0.39	4 694	4 764	94	103	0.2	0.8	0.9	2.1

Table 15.1.2.6 Performance of the 60% CPUE reference points and heavy one-way management responses measured against different biological and fishing industry objectives. Table (a) outlines the simulation details, Table (b) summaries the overfishing probabilities and expected median population sizes; the shaded cells indicated scenarios where 5-year biomass ratios B_{t+5}/B_{MSY} , are above one, and Table (c) summaries the expected median catch statistics and mean number of triggered reference points; the shaded cells highlight the scenarios that result in the best catches, lowest catch variation, highest fishing effort and catch rates, and the lowest number of catch-rate triggers.

(a) Simulation Details

Trawl Sector: Torres Strait; **Model:** Monthly Delay Difference; **Recruitment Models:** Ricker and Beverton-Holt; **Reference Points:** Limit 60% CPUE; Upper – None. **Management Response to Triggered Reference Points:** For Limit, reduce fishing effort by 30%; For Upper, no increase fishing effort.

(b) Biological Measures

Recruitment Model	Test Fishing Effort	5yr	20yr	5yr	20yr	5yr	20yr	5yr	20yr	5yr	20yr
		Probability $B_{t+5} < 20\%K$	Probability $B_{t+20} < 20\%K$	Probability $B_{t+5} < B_{MSY}$	Probability $B_{t+20} < B_{MSY}$	Biomass Ratio B_{t+5}/K	Biomass Ratio B_{t+20}/K	Biomass Ratio B_{t+5}/B_{MSY}	Biomass Ratio B_{t+20}/B_{MSY}		
Ricker	11 000	0.05	0.01	0.61	0.41	0.33	0.40	0.93	1.09		
Ricker	9 000	0.01	0.00	0.34	0.32	0.41	0.43	1.11	1.16		
Ricker	7 000	0.00	0.00	0.14	0.17	0.49	0.47	1.32	1.29		
Ricker	5 000	0.00	0.00	0.05	0.07	0.57	0.53	1.56	1.45		
Ricker	4 000	0.00	0.00	0.01	0.02	0.66	0.62	1.79	1.67		
BH	11 000	0.03	0.02	0.20	0.18	0.34	0.37	1.47	1.61		
BH	9 000	0.01	0.00	0.08	0.11	0.41	0.40	1.73	1.70		
BH	7 000	0.00	0.00	0.04	0.06	0.48	0.45	2.02	1.92		
BH	5 000	0.00	0.00	0.01	0.02	0.55	0.51	2.34	2.17		
BH	4 000	0.00	0.00	0.01	0.01	0.63	0.59	2.68	2.49		

(c) Fishing Industry Measures

Recruitment Model	Test Fishing Nights	5yr	20yr	5yr	20yr	5yr	20yr	5yr	20yr	5yr	20yr	5yr	20yr
		Catch (t)	Catch (t)	Catch Variation	Catch Variation	Fishing Nights	Fishing Nights	CPUE (kg/boat day)	CPUE (kg/boat day)	No. Limit Triggers	No. Limit Triggers	No. Upper Triggers	No. Upper Triggers
Ricker	11 000	610	597	0.44	0.44	11 106	8 088	49	71	1.1	1.9	0.1	0.1
Ricker	9 000	639	611	0.38	0.43	9 478	8 029	58	74	0.6	1.2	0.2	0.3
Ricker	7 000	604	613	0.33	0.40	7 651	6 987	71	81	0.3	0.8	0.4	0.9
Ricker	5 000	543	583	0.29	0.36	5 957	5 734	84	92	0.2	0.5	0.7	1.9
Ricker	4 000	462	510	0.26	0.32	4 475	4 396	96	107	0.1	0.3	1.0	3.2
BH	11 000	662	647	0.36	0.39	11 534	9 189	51	67	0.8	1.5	0.0	0.1
BH	9 000	652	644	0.33	0.38	9 578	8 435	60	72	0.5	1.0	0.2	0.3
BH	7 000	599	627	0.30	0.35	7 669	7 121	70	80	0.2	0.6	0.4	0.8
BH	5 000	531	576	0.28	0.32	5 961	5 780	83	91	0.1	0.4	0.6	1.7
BH	4 000	451	497	0.27	0.30	4 477	4 410	95	105	0.1	0.2	1.0	3.0

Table 15.1.2.7 Performance of the 60% CPUE reference points and moderate one-way management responses measured against different biological and fishing industry objectives. Table (a) outlines the simulation details, Table (b) summaries the overfishing probabilities and expected median population sizes; the shaded cells indicated scenarios where 5-year biomass ratios B_{t+5}/B_{MSY} , are above one, and Table (c) summaries the expected median catch statistics and mean number of triggered reference points; the shaded cells highlight the scenarios that result in the best catches, lowest catch variation, highest fishing effort and catch rates, and the lowest number of catch-rate triggers.

(a) Simulation Details

Trawl Sector: Torres Strait; **Model:** Monthly Delay Difference; **Recruitment Models:** Ricker and Beverton-Holt; **Reference Points:** Limit 60% CPUE; Upper – None. **Management Response to Triggered Reference Points:** For Limit, reduce fishing effort by 10%; For Upper, no increase fishing effort.

(b) Biological Measures

Recruitment Model	Test Fishing Effort	5yr	20yr	5yr	20yr	5yr	20yr	5yr	20yr	5yr	20yr
		Probability $B_{t+5} < 20\%K$	Probability $B_{t+20} < 20\%K$	Probability $B_{t+5} < B_{MSY}$	Probability $B_{t+20} < B_{MSY}$	Biomass Ratio B_{t+5}/K	Biomass Ratio B_{t+20}/K	Biomass Ratio B_{t+5}/B_{MSY}	Biomass Ratio B_{t+20}/B_{MSY}		
Ricker	11 000	0.14	0.01	0.74	0.56	0.30	0.35	0.82	0.95		
Ricker	9 000	0.04	0.00	0.41	0.42	0.39	0.39	1.07	1.07		
Ricker	7 000	0.01	0.00	0.17	0.20	0.48	0.45	1.32	1.22		
Ricker	5 000	0.00	0.00	0.05	0.08	0.57	0.52	1.55	1.43		
Ricker	4 000	0.00	0.00	0.01	0.02	0.66	0.61	1.77	1.65		
BH	11 000	0.07	0.04	0.24	0.23	0.31	0.33	1.34	1.42		
BH	9 000	0.02	0.01	0.09	0.12	0.39	0.38	1.66	1.59		
BH	7 000	0.00	0.00	0.04	0.06	0.47	0.44	1.99	1.84		
BH	5 000	0.00	0.00	0.01	0.02	0.55	0.50	2.33	2.14		
BH	4 000	0.00	0.00	0.01	0.01	0.63	0.58	2.67	2.47		

(c) Fishing Industry Measures

Recruitment Model	Test Fishing Nights	5yr	20yr	5yr	20yr	5yr	20yr	5yr	20yr	5yr	20yr	5yr	20yr
		Catch (t)	Catch (t)	Catch Variation	Catch Variation	Fishing Nights	Fishing Nights	CPUE (kg/boat day)	CPUE (kg/boat day)	No. Limit Triggers	No. Limit Triggers	No. Upper Triggers	No. Upper Triggers
Ricker	11 000	635	606	0.38	0.41	12 288	9 392	43	62	1.4	4.6	0.1	0.1
Ricker	9 000	642	614	0.34	0.40	9 897	8 562	56	66	0.7	2.8	0.2	0.3
Ricker	7 000	606	618	0.30	0.37	7 798	7 195	71	76	0.3	1.6	0.4	0.9
Ricker	5 000	544	583	0.28	0.33	6 020	5 800	84	90	0.2	0.9	0.7	1.9
Ricker	4 000	462	510	0.25	0.30	4 513	4 427	96	106	0.1	0.5	1.0	3.2
BH	11 000	688	672	0.30	0.35	12 495	10 291	46	60	1.1	3.4	0.0	0.1
BH	9 000	656	664	0.29	0.34	9 949	8 896	58	66	0.5	2.0	0.2	0.3
BH	7 000	602	632	0.27	0.32	7 810	7 400	70	77	0.3	1.1	0.4	0.8
BH	5 000	533	576	0.26	0.30	6 046	5 887	83	90	0.1	0.6	0.6	1.7
BH	4 000	451	498	0.26	0.28	4 524	4 442	95	105	0.1	0.4	1.0	3.0

Table 15.1.2.8 Performance of the 60% CPUE reference points and heavy two-way management responses measured against different biological and fishing industry objectives. Table (a) outlines the simulation details, Table (b) summaries the overfishing probabilities and expected median population sizes; the shaded cells indicated scenarios where 5-year biomass ratios B_{t+5}/B_{MSY} , are above one, and Table (c) summaries the expected median catch statistics and mean number of triggered reference points; the shaded cells highlight the scenarios that result in the best catches, lowest catch variation, highest fishing effort and catch rates, and the lowest number of catch-rate triggers.

(a) Simulation Details

Trawl Sector: Torres Strait; **Model:** Monthly Delay Difference; **Recruitment Models:** Ricker and Beverton-Holt; **Reference Points:** Limit 60% CPUE; Upper – 95% percentile. **Management Response to Triggered Reference Points:** For Limit, reduce fishing effort by 30%; For Upper, increase fishing effort by 15%.

(b) Biological Measures

Recruitment Model	Test Fishing Effort	5yr Probability $B_{t+5} < 20\%K$	20yr Probability $B_{t+20} < 20\%K$	5yr Probability $B_{t+5} < B_{MSY}$	20yr Probability $B_{t+20} < B_{MSY}$	5yr Biomass Ratio B_{t+5}/K	20yr Biomass Ratio B_{t+20}/K	5yr Biomass Ratio B_{t+5}/B_{MSY}	20yr Biomass Ratio B_{t+20}/B_{MSY}
Ricker	11 000	0.05	0.00	0.62	0.42	0.33	0.40	0.92	1.09
Ricker	9 000	0.01	0.00	0.36	0.35	0.40	0.42	1.10	1.14
Ricker	7 000	0.00	0.00	0.16	0.23	0.48	0.45	1.30	1.23
Ricker	5 000	0.00	0.00	0.06	0.13	0.55	0.50	1.52	1.36
Ricker	4 000	0.00	0.00	0.02	0.07	0.63	0.55	1.72	1.52
BH	11 000	0.03	0.02	0.20	0.18	0.34	0.37	1.46	1.61
BH	9 000	0.01	0.00	0.08	0.12	0.41	0.40	1.71	1.65
BH	7 000	0.00	0.00	0.04	0.07	0.47	0.43	1.98	1.84
BH	5 000	0.00	0.00	0.01	0.04	0.54	0.48	2.26	2.04
BH	4 000	0.00	0.00	0.01	0.02	0.61	0.54	2.56	2.26

(c) Fishing Industry Measures

Recruitment Model	Test Fishing Nights	5yr Catch (t)	20yr Catch (t)	5yr Catch Variation	20yr Catch Variation	5yr Fishing Nights	20yr Fishing Nights	5yr CPUE (kg/boat day)	20yr CPUE (kg/boat day)	5yr No. Limit Triggers	20yr No. Limit Triggers	5yr No. Upper Triggers	20yr No. Upper Triggers
Ricker	11 000	610	597	0.44	0.44	11 253	8 089	48	71	1.1	1.9	0.0	0.1
Ricker	9 000	639	610	0.39	0.44	9 740	8 316	58	73	0.6	1.2	0.1	0.2
Ricker	7 000	607	614	0.36	0.42	7 962	7 486	71	79	0.3	0.8	0.3	0.4
Ricker	5 000	551	587	0.35	0.41	6 429	6 367	83	89	0.2	0.5	0.5	0.7
Ricker	4 000	475	526	0.36	0.43	5 021	5 137	95	99	0.1	0.3	0.9	1.3
BH	11 000	662	647	0.36	0.39	11 595	9 219	51	67	0.8	1.5	0.0	0.0
BH	9 000	653	645	0.34	0.38	9 786	8 696	60	72	0.5	1.0	0.1	0.1
BH	7 000	603	631	0.33	0.37	7 973	7 582	70	79	0.2	0.6	0.3	0.3
BH	5 000	538	583	0.34	0.37	6 391	6 305	82	89	0.1	0.4	0.5	0.7
BH	4 000	461	512	0.36	0.41	4 979	5 109	94	99	0.1	0.2	0.8	1.2

Table 15.1.2.9 Performance of the 60% CPUE reference points and moderate two-way management responses measured against different biological and fishing industry objectives. Table (a) outlines the simulation details, Table (b) summaries the overfishing probabilities and expected median population sizes; the shaded cells indicated scenarios where 5-year biomass ratios B_{t+5}/B_{MSY} , are above one, and Table (c) summaries the expected median catch statistics and mean number of triggered reference points; the shaded cells highlight the scenarios that result in the best catches, lowest catch variation, highest fishing effort and catch rates, and the lowest number of catch-rate triggers.

(a) Simulation Details

Trawl Sector: Torres Strait; **Model:** Monthly Delay Difference; **Recruitment Models:** Ricker and Beverton-Holt; **Reference Points:** Limit 60% CPUE; Upper – 95% percentile. **Management Response to Triggered Reference Points:** For Limit, reduce fishing effort by 10%; For Upper, increase fishing effort by 5%.

(b) Biological Measures

Recruitment Model	Test Fishing Effort	5yr Probability $B_{t+5} < 20\%K$	20yr Probability $B_{t+20} < 20\%K$	5yr Probability $B_{t+5} < B_{MSY}$	20yr Probability $B_{t+20} < B_{MSY}$	5yr Biomass Ratio B_{t+5}/K	20yr Biomass Ratio B_{t+20}/K	5yr Biomass Ratio B_{t+5}/B_{MSY}	20yr Biomass Ratio B_{t+20}/B_{MSY}
Ricker	11 000	0.14	0.02	0.74	0.57	0.30	0.35	0.82	0.95
Ricker	9 000	0.04	0.00	0.41	0.43	0.39	0.39	1.06	1.05
Ricker	7 000	0.01	0.00	0.17	0.23	0.48	0.44	1.31	1.20
Ricker	5 000	0.00	0.00	0.05	0.10	0.56	0.51	1.54	1.37
Ricker	4 000	0.00	0.00	0.02	0.04	0.65	0.58	1.76	1.56
BH	11 000	0.07	0.04	0.24	0.23	0.31	0.33	1.33	1.41
BH	9 000	0.02	0.01	0.10	0.13	0.39	0.37	1.66	1.58
BH	7 000	0.00	0.00	0.04	0.06	0.47	0.43	1.97	1.82
BH	5 000	0.00	0.00	0.01	0.03	0.54	0.49	2.29	2.06
BH	4 000	0.00	0.00	0.01	0.01	0.62	0.56	2.62	2.33

(c) Fishing Industry Measures

Recruitment Model	Test Fishing Nights	5yr Catch (t)	20yr Catch (t)	5yr Catch Variation	20yr Catch Variation	5yr Fishing Nights	20yr Fishing Nights	5yr CPUE (kg/boat day)	20yr CPUE (kg/boat day)	5yr No. Limit Triggers	20yr No. Limit Triggers	5yr No. Upper Triggers	20yr No. Upper Triggers
Ricker	11 000	635	606	0.38	0.41	12 324	9 422	43	61	1.4	4.7	0.1	0.1
Ricker	9 000	643	614	0.34	0.40	9 954	8 712	56	66	0.7	2.8	0.2	0.2
Ricker	7 000	607	619	0.32	0.39	7 935	7 468	71	76	0.3	1.6	0.3	0.6
Ricker	5 000	549	585	0.30	0.37	6 232	6 218	84	89	0.2	0.9	0.6	1.2
Ricker	4 000	469	519	0.29	0.38	4 739	4 918	96	104	0.1	0.5	1.0	2.2
BH	11 000	688	672	0.30	0.35	12 519	10 321	46	60	1.1	3.5	0.0	0.0
BH	9 000	656	664	0.29	0.34	9 990	8 991	58	66	0.5	2.0	0.1	0.2
BH	7 000	602	632	0.29	0.33	7 953	7 612	70	76	0.3	1.1	0.3	0.5
BH	5 000	537	579	0.29	0.34	6 237	6 176	83	89	0.1	0.6	0.6	1.1
BH	4 000	456	505	0.29	0.36	4 738	4 904	94	103	0.1	0.4	0.9	2.1

Table 15.1.2.10 Performance of the 80% CPUE reference points and heavy one-way management responses measured against different biological and fishing industry objectives. Table (a) outlines the simulation details, Table (b) summaries the overfishing probabilities and expected median population sizes; the shaded cells indicated scenarios where 5-year biomass ratios B_{t+5}/B_{MSY} , are above one, and Table (c) summaries the expected median catch statistics and mean number of triggered reference points; the shaded cells highlight the scenarios that result in the best catches, lowest catch variation, highest fishing effort and catch rates, and the lowest number of catch-rate triggers.

(a) Simulation Details

Trawl Sector: Torres Strait; **Model:** Monthly Delay Difference; **Recruitment Models:** Ricker and Beverton-Holt; **Reference Points:** Limit 80% CPUE; Upper – None.
Management Response to Triggered Reference Points: For Limit, reduce fishing effort by 30%; For Upper, no increase in fishing effort.

(b) Biological Measures

Recruitment Model	Test Fishing Effort	5yr Probability $B_{t+5} < 20\%K$	20yr Probability $B_{t+20} < 20\%K$	5yr Probability $B_{t+5} < B_{MSY}$	20yr Probability $B_{t+20} < B_{MSY}$	5yr Biomass Ratio B_{t+5}/K	20yr Biomass Ratio B_{t+20}/K	5yr Biomass Ratio B_{t+5}/B_{MSY}	20yr Biomass Ratio B_{t+20}/B_{MSY}
Ricker	11 000	0.01	0.00	0.36	0.16	0.42	0.54	1.13	1.48
Ricker	9 000	0.00	0.00	0.21	0.14	0.47	0.55	1.27	1.48
Ricker	7 000	0.00	0.00	0.09	0.08	0.52	0.57	1.44	1.54
Ricker	5 000	0.00	0.00	0.03	0.03	0.59	0.60	1.62	1.65
Ricker	4 000	0.00	0.00	0.01	0.01	0.67	0.66	1.82	1.78
BH	11 000	0.00	0.00	0.09	0.06	0.42	0.52	1.82	2.23
BH	9 000	0.00	0.00	0.04	0.04	0.46	0.52	1.97	2.26
BH	7 000	0.00	0.00	0.02	0.03	0.51	0.55	2.18	2.29
BH	5 000	0.00	0.00	0.01	0.01	0.57	0.58	2.42	2.46
BH	4 000	0.00	0.00	0.01	0.01	0.64	0.63	2.71	2.63

(c) Fishing Industry Measures

Recruitment Model	Test Fishing Nights	5yr Catch (t)	20yr Catch (t)	5yr Catch Variation	20yr Catch Variation	5yr Fishing Nights	20yr Fishing Nights	5yr CPUE (kg/boat day)	20yr CPUE (kg/boat day)	5yr No. Limit Triggers	20yr No. Limit Triggers	5yr No. Upper Triggers	20yr No. Upper Triggers
Ricker	11 000	510	537	0.50	0.55	7 528	5 354	63	95	2.1	3.4	0.1	0.1
Ricker	9 000	567	537	0.46	0.54	7 749	5 475	68	95	1.4	2.6	0.2	0.3
Ricker	7 000	570	537	0.41	0.52	6 916	5 411	75	99	0.9	2.0	0.4	0.9
Ricker	5 000	533	536	0.36	0.47	5 591	4 990	85	104	0.6	1.5	0.7	1.9
Ricker	4 000	459	499	0.32	0.42	4 318	4 018	96	113	0.4	1.0	1.0	3.2
BH	11 000	546	536	0.44	0.54	7 866	5 575	65	92	2.0	3.3	0.0	0.1
BH	9 000	576	534	0.42	0.53	7 777	5 524	70	93	1.4	2.5	0.2	0.3
BH	7 000	564	536	0.39	0.51	6 827	5 483	75	97	0.9	1.9	0.4	0.8
BH	5 000	522	525	0.35	0.47	5 546	4 921	84	103	0.6	1.5	0.6	1.7
BH	4 000	447	487	0.32	0.43	4 295	4 001	95	111	0.4	1.1	1.0	3.0

Table 15.1.2.11 Performance of the 80% CPUE reference points and moderate one-way management responses measured against different biological and fishing industry objectives. Table (a) outlines the simulation details, Table (b) summaries the overfishing probabilities and expected median population sizes; the shaded cells indicated scenarios where 5-year biomass ratios B_{t+5}/B_{MSY} , are above one, and Table (c) summaries the expected median catch statistics and mean number of triggered reference points; the shaded cells highlight the scenarios that result in the best catches, lowest catch variation, highest fishing effort and catch rates, and the lowest number of catch-rate triggers.

(a) Simulation Details

Trawl Sector: Torres Strait; **Model:** Monthly Delay Difference; **Recruitment Models:** Ricker and Beverton-Holt; **Reference Points:** Limit 80% CPUE; Upper – None.
Management Response to Triggered Reference Points: For Limit, reduce fishing effort by 10%; For Upper, no increase in fishing effort.

(b) Biological Measures

Recruitment Model	Test Fishing Effort	5yr Probability $B_{t+5} < 20\%K$	20yr Probability $B_{t+20} < 20\%K$	5yr Probability $B_{t+5} < B_{MSY}$	20yr Probability $B_{t+20} < B_{MSY}$	5yr Biomass Ratio B_{t+5}/K	20yr Biomass Ratio B_{t+20}/K	5yr Biomass Ratio B_{t+5}/B_{MSY}	20yr Biomass Ratio B_{t+20}/B_{MSY}
Ricker	11 000	0.10	0.00	0.65	0.27	0.33	0.46	0.90	1.25
Ricker	9 000	0.02	0.00	0.33	0.20	0.42	0.49	1.13	1.32
Ricker	7 000	0.01	0.00	0.14	0.10	0.50	0.52	1.34	1.42
Ricker	5 000	0.00	0.00	0.04	0.04	0.58	0.57	1.57	1.56
Ricker	4 000	0.00	0.00	0.01	0.01	0.66	0.63	1.80	1.73
BH	11 000	0.04	0.00	0.18	0.08	0.34	0.44	1.45	1.90
BH	9 000	0.01	0.00	0.08	0.06	0.41	0.47	1.75	1.99
BH	7 000	0.00	0.00	0.03	0.03	0.48	0.50	2.04	2.14
BH	5 000	0.00	0.00	0.01	0.01	0.56	0.55	2.35	2.32
BH	4 000	0.00	0.00	0.01	0.01	0.63	0.61	2.67	2.57

(c) Fishing Industry Measures

Recruitment Model	Test Fishing Nights	5yr Catch (t)	20yr Catch (t)	5yr Catch Variation	20yr Catch Variation	5yr Fishing Nights	20yr Fishing Nights	5yr CPUE (kg/boat day)	20yr CPUE (kg/boat day)	5yr No. Limit Triggers	20yr No. Limit Triggers	5yr No. Upper Triggers	20yr No. Upper Triggers
Ricker	11 000	609	577	0.39	0.46	11 253	6 616	49	81	2.6	7.7	0.1	0.1
Ricker	9 000	622	575	0.36	0.45	9 202	6 626	61	85	1.7	5.6	0.2	0.3
Ricker	7 000	596	576	0.32	0.43	7 442	6 232	72	90	1.1	3.9	0.4	0.9
Ricker	5 000	541	561	0.30	0.40	5 866	5 265	84	97	0.7	2.6	0.7	1.9
Ricker	4 000	461	502	0.27	0.36	4 429	4 142	96	109	0.4	1.7	1.0	3.2
BH	11 000	651	591	0.32	0.43	11 300	6 961	53	80	2.5	7.3	0.0	0.1
BH	9 000	631	589	0.31	0.43	9 217	6 803	62	84	1.6	5.3	0.2	0.3
BH	7 000	589	582	0.30	0.41	7 440	6 270	72	89	1.1	3.7	0.4	0.8
BH	5 000	528	549	0.29	0.39	5 867	5 254	83	97	0.7	2.6	0.6	1.7
BH	4 000	448	489	0.27	0.36	4 426	4 110	95	107	0.4	1.7	1.0	3.0

Table 15.1.2.12 Performance of the 80% CPUE reference points and heavy two-way management responses measured against different biological and fishing industry objectives. Table (a) outlines the simulation details, Table (b) summaries the overfishing probabilities and expected median population sizes; the shaded cells indicated scenarios where 5-year biomass ratios B_{t+5}/B_{MSY} , are above one, and Table (c) summaries the expected median catch statistics and mean number of triggered reference points; the shaded cells highlight the scenarios that result in the best catches, lowest catch variation, highest fishing effort and catch rates, and the lowest number of catch-rate triggers.

(a) Simulation details.

Trawl Sector: Torres Strait; **Model:** Monthly Delay Difference; **Recruitment Models:** Ricker and Beverton-Holt; **Reference Points:** Limit 80% CPUE; Upper – None.
Management Response to Triggered Reference Points: For Limit, reduce fishing effort by 30%; For Upper, increase fishing effort by 15%.

(b) Biological Measures.

Recruitment Model	Test Fishing Effort	5yr Probability $B_{t+5} < 20\%K$	20yr Probability $B_{t+20} < 20\%K$	5yr Probability $B_{t+5} < B_{MSY}$	20yr Probability $B_{t+20} < B_{MSY}$	5yr Biomass Ratio B_{t+5}/K	20yr Biomass Ratio B_{t+20}/K	5yr Biomass Ratio B_{t+5}/B_{MSY}	20yr Biomass Ratio B_{t+20}/B_{MSY}
Ricker	11 000	0.01	0.00	0.37	0.17	0.41	0.54	1.13	1.48
Ricker	9 000	0.00	0.00	0.22	0.16	0.46	0.54	1.25	1.48
Ricker	7 000	0.00	0.00	0.10	0.13	0.51	0.55	1.41	1.50
Ricker	5 000	0.00	0.00	0.04	0.09	0.57	0.56	1.58	1.54
Ricker	4 000	0.00	0.00	0.01	0.06	0.64	0.59	1.76	1.61
BH	11 000	0.00	0.00	0.09	0.06	0.42	0.51	1.81	2.21
BH	9 000	0.00	0.00	0.05	0.06	0.46	0.52	1.96	2.22
BH	7 000	0.00	0.00	0.03	0.04	0.50	0.52	2.14	2.25
BH	5 000	0.00	0.00	0.01	0.02	0.55	0.55	2.35	2.36
BH	4 000	0.00	0.00	0.01	0.02	0.62	0.57	2.60	2.43

(c) Fishing Industry Measures

Recruitment Model	Test Fishing Nights	5yr Catch (t)	20yr Catch (t)	5yr Catch Variation	20yr Catch Variation	5yr Fishing Nights	20yr Fishing Nights	5yr CPUE (kg/boat day)	20yr CPUE (kg/boat day)	5yr No. Limit Triggers	20yr No. Limit Triggers	5yr No. Upper Triggers	20yr No. Upper Triggers
Ricker	11 000	510	538	0.50	0.55	7 545	5 354	63	94	2.2	3.4	0.0	0.1
Ricker	9 000	567	537	0.47	0.54	7 948	5 442	68	94	1.4	2.6	0.1	0.2
Ricker	7 000	570	537	0.43	0.54	7 224	5 449	75	96	0.9	2.0	0.3	0.4
Ricker	5 000	540	540	0.41	0.52	6 066	5 389	84	99	0.6	1.5	0.5	0.7
Ricker	4 000	470	518	0.40	0.52	4 861	4 768	95	104	0.4	1.0	0.9	1.3
BH	11 000	545	536	0.44	0.54	7 866	5 584	65	92	2.0	3.3	0.0	0.0
BH	9 000	577	534	0.43	0.54	7 972	5 524	70	92	1.4	2.5	0.1	0.1
BH	7 000	565	538	0.41	0.53	7 141	5 535	75	95	0.9	1.9	0.3	0.3
BH	5 000	528	530	0.41	0.52	5 977	5 296	83	99	0.6	1.5	0.5	0.7
BH	4 000	457	502	0.41	0.52	4 787	4 639	94	104	0.4	1.1	0.8	1.2

Table 15.1.2.13 Performance of the 80% CPUE reference points and moderate two-way management responses measured against different biological and fishing industry objectives. Table (a) outlines the simulation details, Table (b) summaries the overfishing probabilities and expected median population sizes; the shaded cells indicated scenarios where 5-year biomass ratios B_{t+5}/B_{MSY} , are above one, and Table (c) summaries the expected median catch statistics and mean number of triggered reference points; the shaded cells highlight the scenarios that result in the best catches, lowest catch variation, highest fishing effort and catch rates, and the lowest number of catch-rate triggers.

(a) Simulation Details

Trawl Sector: Torres Strait; **Model:** Monthly Delay Difference; **Recruitment Models:** Ricker and Beverton-Holt; **Reference Points:** Limit 80% CPUE; Upper – None.
Management Response to Triggered Reference Points: For Limit, reduce fishing effort by 10%; For Upper, increase fishing effort by 5%.

(b) Biological Measures

Recruitment Model	Test Fishing Effort	5yr Probability $B_{t+5} < 20\%K$	20yr Probability $B_{t+20} < 20\%K$	5yr Probability $B_{t+5} < B_{MSY}$	20yr Probability $B_{t+20} < B_{MSY}$	5yr Biomass Ratio B_{t+5}/K	20yr Biomass Ratio B_{t+20}/K	5yr Biomass Ratio B_{t+5}/B_{MSY}	20yr Biomass Ratio B_{t+20}/B_{MSY}
Ricker	11 000	0.10	0.00	0.65	0.27	0.33	0.45	0.90	1.25
Ricker	9 000	0.02	0.00	0.34	0.21	0.41	0.48	1.12	1.29
Ricker	7 000	0.01	0.00	0.14	0.13	0.49	0.51	1.34	1.38
Ricker	5 000	0.00	0.00	0.04	0.06	0.57	0.55	1.55	1.50
Ricker	4 000	0.00	0.00	0.02	0.03	0.65	0.60	1.77	1.63
BH	11 000	0.04	0.00	0.18	0.08	0.34	0.44	1.45	1.89
BH	9 000	0.01	0.00	0.08	0.06	0.41	0.46	1.74	1.98
BH	7 000	0.00	0.00	0.03	0.04	0.48	0.49	2.03	2.09
BH	5 000	0.00	0.00	0.01	0.02	0.55	0.53	2.32	2.23
BH	4 000	0.00	0.00	0.01	0.01	0.63	0.58	2.63	2.43

(c) Fishing Industry Measures

Recruitment Model	Test Fishing Nights	5yr Catch (t)	20yr Catch (t)	5yr Catch Variation	20yr Catch Variation	5yr Fishing Nights	20yr Fishing Nights	5yr CPUE (kg/boat day)	20yr CPUE (kg/boat day)	5yr No. Limit Triggers	20yr No. Limit Triggers	5yr No. Upper Triggers	20yr No. Upper Triggers
Ricker	11 000	609	577	0.39	0.46	11 298	6 615	49	81	2.6	7.8	0.1	0.1
Ricker	9 000	622	575	0.36	0.46	9 287	6 632	61	84	1.7	5.6	0.2	0.2
Ricker	7 000	597	576	0.34	0.45	7 577	6 419	72	90	1.1	3.9	0.3	0.6
Ricker	5 000	542	563	0.32	0.44	6 010	5 657	84	96	0.7	2.6	0.6	1.2
Ricker	4 000	467	512	0.30	0.44	4 655	4 627	96	106	0.4	1.7	1.0	2.2
BH	11 000	651	591	0.32	0.43	11 341	6 961	53	80	2.5	7.3	0.0	0.0
BH	9 000	631	589	0.31	0.43	9 307	6 833	62	84	1.6	5.3	0.1	0.2
BH	7 000	592	583	0.31	0.43	7 546	6 458	72	88	1.1	3.7	0.3	0.5
BH	5 000	531	553	0.31	0.42	6 001	5 544	83	96	0.7	2.6	0.6	1.1
BH	4 000	453	499	0.31	0.43	4 635	4 552	94	105	0.4	1.7	0.9	2.1

Table 15.1.2.14 Performance of the fishing mortality reference points measured against different biological and fishing industry objectives. Table (a) outlines the simulation details, Table (b) summaries the overfishing probabilities and expected median population sizes; the shaded cells indicated scenarios where 5-year biomass ratios B_{t+5}/B_{MSY} , are above one, and Table (c) summaries the expected median catch statistics and mean number of triggered reference points; the shaded cells highlight the scenarios that result in the best catches, lowest catch variation, highest fishing effort and catch rates, and the lowest number of catch-rate triggers.

(a) Simulation Details

Trawl Sector: Torres Strait; **Model:** Monthly Delay Difference; **Recruitment Models:** Ricker.
Reference Points: Fishing at E_{MSY} , Fishing at $3/4E_{MSY}$ and Fishing at $2/3E_{MSY}$.
Management Response to Triggered Reference Points: Stock assessment every second year with fishing effort adjusted as required.

(b) Biological Measures

Test Fishing Effort	5yr	20yr	5yr	20yr	5yr	20yr	5yr	20yr
	Probability $B_{t+5} < 20\%K$	Probability $B_{t+20} < 20\%K$	Probability $B_{t+5} < B_{MSY}$	Probability $B_{t+20} < B_{MSY}$	Biomass Ratio B_{t+5}/K	Biomass Ratio B_{t+20}/K	Biomass Ratio B_{t+5}/B_{MSY}	Biomass Ratio B_{t+20}/B_{MSY}
E_{MSY}	0.17	0.41	0.54	0.63	0.35	0.27	0.96	0.74
$3/4E_{MSY}$	0.10	0.28	0.33	0.45	0.44	0.40	1.21	1.10
$2/3E_{MSY}$	0.09	0.28	0.25	0.43	0.48	0.42	1.28	1.17

(c) Fishing Industry Measures

Test Fishing Nights	5yr	20yr	5yr	20yr	5yr	20yr
	Catch (t)	Catch (t)	Catch Variation	Catch Variation	CPUE (kg/boat day)	CPUE (kg/boat day)
E_{MSY}	633	483	0.38	0.59	52.0	46.3
$3/4E_{MSY}$	590	490	0.37	0.53	65.0	68.6
$2/3E_{MSY}$	580	471	0.36	0.54	70.7	75.5

Table 15.1.2.15 Performance of status quo (no) management responses measured against different biological and fishing industry objectives. Table (a) outlines the simulation details, Table (b) summaries the overfishing probabilities and expected median population sizes; the shaded cells indicated scenarios where 5-year biomass ratios B_{t+5}/B_{MSY} , are above one, and Table (c) summaries the expected median catch statistics and mean number of triggered reference points; the shaded cells highlight the scenarios that result in the best catches, lowest catch variation, highest fishing effort and catch rates, and the lowest number of catch-rate triggers.

(a) Simulation details

Trawl Sector: Torres Strait; **Model:** Surplus Production Model - Fox with $B_0 < K$ penalty (constrained) and Fox unconstrained; all data **Reference Points:** None
Management Responses to Triggered Reference Points: status quo – None.

(b) Biological Measures

Model	Test Fishing Effort	5yr Probability $B_{t+5} < 20\%K$	20yr Probability $B_{t+20} < 20\%K$	5yr Probability $B_{t+5} < B_{MSY}$	20yr Probability $B_{t+20} < B_{MSY}$	5yr Biomass Ratio B_{t+5}/K	20yr Biomass Ratio B_{t+20}/K	5yr Biomass Ratio B_{t+5}/B_{MSY}	20yr Biomass Ratio B_{t+20}/B_{MSY}
constrained	12 000	0.02	0.17	0.98	1.00	0.29	0.23	0.76	0.60
constrained	10 000	0.00	0.03	0.63	0.99	0.34	0.28	0.91	0.75
constrained	8 000	0.00	0.00	0.14	0.53	0.41	0.35	1.08	0.92
constrained	6 000	0.00	0.00	0.00	0.08	0.49	0.43	1.29	1.15
constrained	4 000	0.00	0.00	0.00	0.00	0.58	0.54	1.54	1.43
Unconstrained	12 000	0.00	0.00	0.29	0.77	0.40	0.33	1.05	0.86
Unconstrained	10 000	0.00	0.00	0.02	0.35	0.45	0.39	1.19	1.02
Unconstrained	8 000	0.00	0.00	0.00	0.01	0.52	0.46	1.35	1.21
Unconstrained	6 000	0.00	0.00	0.00	0.00	0.59	0.54	1.54	1.42
Unconstrained	4 000	0.00	0.00	0.00	0.00	0.67	0.65	1.76	1.69

(c) Fishing Industry Measures

Model	Test Fishing Nights	5yr Catch (t)	20yr Catch (t)	5yr Catch Variation	20yr Catch Variation	5yr CPUE (kg/boat day)	20yr CPUE (kg/boat day)
constrained	12 000	656	626	0.05	0.04	51	48
constrained	10 000	631	636	0.03	0.01	61	60
constrained	8 000	586	627	0.10	0.06	73	74
constrained	6 000	519	589	0.16	0.10	87	93
constrained	4 000	423	507	0.22	0.13	105	116
Unconstrained	12 000	749	716	0.06	0.04	57	56
Unconstrained	10 000	688	693	0.01	0.01	64	66
Unconstrained	8 000	612	649	0.04	0.04	73	78
Unconstrained	6 000	516	577	0.09	0.08	83	92
Unconstrained	4 000	400	473	0.13	0.11	94	109

Table 15.1.2.16 Performance of the 60% CPUE and one-way management responses measured against different biological and fishing industry objectives. Table (a) outlines the simulation details, Table (b) summaries the overfishing probabilities and expected median population sizes; the shaded cells indicated scenarios where 5-year biomass ratios B_{t+5}/B_{MSY} , are above one, and Table (c) summaries the expected median catch statistics and mean number of triggered reference points; the shaded cells highlight the scenarios that result in the best catches, lowest catch variation, highest fishing effort and catch rates, and the lowest number of catch-rate triggers.

(a) Simulation Details											
Trawl Sector: Torres Strait; Model: Surplus Production Model - Fox with $B_0 < K$ penalty (constrained); all data Reference Points: Limit 60% CPUE; Upper – None.											
Management Responses to Triggered Reference Points: For Limit reduce effort by 10%, compared to reduce effort by 30%.											
(b) Biological Measures											
Percentage effort reduction	Test Fishing Effort	5yr Probability $B_{t+5} < 20\%K$	20yr Probability $B_{t+20} < 20\%K$	5yr Probability $B_{t+5} < B_{MSY}$	20yr Probability $B_{t+20} < B_{MSY}$	5yr Biomass Ratio B_{t+5}/K	20yr Biomass Ratio B_{t+20}/K	5yr Biomass Ratio B_{t+5}/B_{MSY}	20yr Biomass Ratio B_{t+20}/B_{MSY}		
10	12 000	0.00	0.00	0.81	0.78	0.33	0.33	0.87	0.87		
10	10 000	0.00	0.00	0.62	0.79	0.34	0.33	0.91	0.87		
10	8 000	0.00	0.00	0.13	0.52	0.41	0.35	1.08	0.92		
10	6 000	0.00	0.00	0.00	0.07	0.49	0.43	1.29	1.15		
10	4 000	0.00	0.00	0.00	0.00	0.58	0.54	1.54	1.43		
30	12 000	0.00	0.00	0.23	0.54	0.39	0.35	1.04	0.92		
30	10 000	0.00	0.00	0.59	0.16	0.35	0.40	0.91	1.06		
30	8 000	0.00	0.00	0.13	0.51	0.41	0.35	1.08	0.93		
30	6 000	0.00	0.00	0.00	0.07	0.49	0.43	1.30	1.14		
30	4 000	0.00	0.00	0.00	0.00	0.58	0.54	1.54	1.42		
(c) Fishing Industry Measures											
Percentage effort reduction	Test Fishing Nights	5yr Catch (t)	20yr Catch (t)	5yr Catch Variation	20yr Catch Variation	5yr Fishing Nights	20yr Fishing Nights	5yr CPUE (kg/boat day)	20yr CPUE (kg/boat day)	5yr No. Limit Triggers	20yr No. Limit Triggers
10	12 000	630	633	0.07	0.03	10 413	9 042	59	71	2.0	3.6
10	10 000	634	636	0.03	0.01	10 636	8 808	61	71	0.5	2.0
10	8 000	589	628	0.10	0.06	8 733	8 701	73	75	0.3	0.4
10	6 000	521	589	0.16	0.10	6 803	6 806	87	93	0.3	0.3
10	4 000	422	507	0.22	0.13	4 861	4 863	105	116	0.3	0.3
30	12 000	618	634	0.13	0.06	8 842	8 785	70	74	1.3	1.4
30	10 000	639	631	0.03	0.02	10 657	7 488	61	86	0.4	1.3
30	8 000	593	629	0.10	0.05	8 746	8 707	73	75	0.3	0.4
30	6 000	524	590	0.16	0.09	6 800	6 795	88	93	0.3	0.3
30	4 000	425	508	0.22	0.13	4 858	4 865	105	116	0.3	0.3

Table 15.1.2.17 Performance of the 70% CPUE and one-way management responses measured against different biological and fishing industry objectives. Table (a) outlines the simulation details, Table (b) summaries the overfishing probabilities and expected median population sizes; the shaded cells indicated scenarios where 5-year biomass ratios B_{t+5}/B_{MSY} , are above one, and Table (c) summaries the expected median catch statistics and mean number of triggered reference points; the shaded cells highlight the scenarios that result in the best catches, lowest catch variation, highest fishing effort and catch rates, and the lowest number of catch-rate triggers.

(a) Simulation details

Trawl Sector: Torres Strait; **Model:** Surplus Production Model – Fox with $B_0 < K$ penalty (constrained); all data **Reference Points:** Limit 70% CPUE; Upper – None.
Management Responses to Triggered Reference Points: For Limit reduce effort by 10%, compared to reduce effort by 30%.

(b) Biological Measures

Percentage effort reduction	Test Fishing Effort	5yr Probability $B_{t+5} < 20\%K$	20yr Probability $B_{t+20} < 20\%K$	5yr Probability $B_{t+5} < B_{MSY}$	20yr Probability $B_{t+20} < B_{MSY}$	5yr Biomass Ratio B_{t+5}/K	20yr Biomass Ratio B_{t+20}/K	5yr Biomass Ratio B_{t+5}/B_{MSY}	20yr Biomass Ratio B_{t+20}/B_{MSY}
10	12 000	0.00	0.00	0.32	0.19	0.37	0.38	0.98	1.01
10	10 000	0.00	0.00	0.19	0.19	0.38	0.38	1.01	1.02
10	8 000	0.00	0.00	0.11	0.19	0.41	0.38	1.09	1.01
10	6 000	0.00	0.00	0.00	0.06	0.49	0.43	1.30	1.15
10	4 000	0.00	0.00	0.00	0.00	0.58	0.54	1.54	1.43
30	12 000	0.00	0.00	0.09	0.01	0.41	0.46	1.10	1.22
30	10 000	0.00	0.00	0.04	0.14	0.44	0.40	1.15	1.06
30	8 000	0.00	0.00	0.10	0.01	0.42	0.46	1.10	1.21
30	6 000	0.00	0.00	0.00	0.07	0.49	0.43	1.30	1.15
30	4 000	0.00	0.00	0.00	0.00	0.59	0.54	1.55	1.42

(c) Fishing Industry Measures

Percentage effort reduction	Test Fishing Nights	5yr Catch (t)	20yr Catch (t)	5yr Catch Variation	20yr Catch Variation	5yr Fishing Nights	20yr Fishing Nights	5yr CPUE (kg/boat day)	20yr CPUE (kg/boat day)	5yr No. Limit Triggers	20yr No. Limit Triggers
10	12 000	598	622	0.06	0.03	8 975	7 569	66	82	4.0	5.5
10	10 000	594	622	0.05	0.04	8 889	7 769	69	82	2.4	3.9
10	8 000	583	622	0.14	0.07	8 655	7 760	74	82	1.0	2.0
10	6 000	516	588	0.20	0.11	6 790	6 782	88	93	0.9	0.9
10	4 000	419	507	0.25	0.14	4 859	4 856	105	116	0.8	0.8
30	12 000	554	598	0.09	0.06	8 666	6 202	73	99	2.1	2.8
30	10 000	551	607	0.20	0.10	7 478	7 480	79	86	1.8	1.8
30	8 000	575	608	0.22	0.11	8 731	6 127	74	99	0.9	1.8
30	6 000	509	586	0.27	0.13	6 794	6 796	88	93	0.8	0.8
30	4 000	412	505	0.31	0.16	4 854	4 860	105	116	0.8	0.8

Table 15.1.2.18 Performance of the 80% CPUE and one-way management responses measured against different biological and fishing industry objectives. Table (a) outlines the simulation details, Table (b) summaries the overfishing probabilities and expected median population sizes; the shaded cells indicated scenarios where 5-year biomass ratios B_{t+5}/B_{MSY} , are above one, and Table (c) summaries the expected median catch statistics and mean number of triggered reference points; the shaded cells highlight the scenarios that result in the best catches, lowest catch variation, highest fishing effort and catch rates, and the lowest number of catch-rate triggers.

(a) Simulation Details

Trawl Sector: Torres Strait; **Model:** Surplus Production Model – Fox with $B_0 < K$ penalty (constrained); all data **Reference Points:** Limit 80% CPUE; Upper – None.
Management Responses to Triggered Reference Points: For Limit reduce effort by 10%, compared to reduce effort by 30%.

(b) Biological Measures

Percentage effort reduction	Test Fishing Effort	5yr Probability $B_{t+5} < 20\%K$	20yr Probability $B_{t+20} < 20\%K$	5yr Probability $B_{t+5} < B_{MSY}$	20yr Probability $B_{t+20} < B_{MSY}$	5yr Biomass Ratio B_{t+5}/K	20yr Biomass Ratio B_{t+20}/K	5yr Biomass Ratio B_{t+5}/B_{MSY}	20yr Biomass Ratio B_{t+20}/B_{MSY}
10	12 000	0.00	0.00	0.29	0.06	0.38	0.44	1.00	1.15
10	10 000	0.00	0.00	0.09	0.06	0.43	0.43	1.13	1.14
10	8 000	0.00	0.00	0.03	0.05	0.44	0.43	1.17	1.15
10	6 000	0.00	0.00	0.00	0.02	0.49	0.44	1.31	1.16
10	4 000	0.00	0.00	0.00	0.00	0.59	0.54	1.55	1.43
30	12 000	0.00	0.00	0.29	0.06	0.50	0.46	1.31	1.23
30	10 000	0.00	0.00	0.09	0.06	0.46	0.51	1.22	1.35
30	8 000	0.00	0.00	0.03	0.05	0.47	0.47	1.25	1.24
30	6 000	0.00	0.00	0.00	0.02	0.50	0.45	1.32	1.18
30	4 000	0.00	0.00	0.00	0.00	0.59	0.54	1.57	1.44

(c) Fishing Industry Measures

Percentage effort reduction	Test Fishing Nights	5yr Catch (t)	20yr Catch (t)	5yr Catch Variation	20yr Catch Variation	5yr Fishing Nights	20yr Fishing Nights	5yr CPUE (kg/boat day)	20yr CPUE (kg/boat day)	5yr No. Limit Triggers	20yr No. Limit Triggers
10	12 000	593	604	0.07	0.04	8 310	6 665	67	94	4.9	7.2
10	10 000	568	603	0.04	0.04	7 681	6 456	76	93	4.1	5.6
10	8 000	555	601	0.12	0.07	7 729	6 479	79	93	2.3	3.7
10	6 000	514	584	0.19	0.11	6 616	6 515	89	96	1.4	1.5
10	4 000	419	505	0.25	0.14	4 827	4 818	105	117	1.2	1.2
30	12 000	509	571	0.11	0.08	6 173	6 168	88	100	3.0	3.1
30	10 000	523	575	0.14	0.09	7 402	5 248	83	110	2.2	3.0
30	8 000	521	572	0.21	0.11	6 155	6 100	87	101	1.9	2.1
30	6 000	510	583	0.27	0.13	6 728	6 642	89	95	1.2	1.3
30	4 000	413	503	0.31	0.16	4 832	4 831	105	117	1.1	1.1

Table 15.1.2.19 Performance of the 60% CPUE and one-way management responses measured against different biological and fishing industry objectives. Table (a) outlines the simulation details, Table (b) summaries the overfishing probabilities and expected median population sizes; the shaded cells indicated scenarios where 5-year biomass ratios B_{t+5}/B_{MSY} , are above one, and Table (c) summaries the expected median catch statistics and mean number of triggered reference points; the shaded cells highlight the scenarios that result in the best catches, lowest catch variation, highest fishing effort and catch rates, and the lowest number of catch-rate triggers.

(a) Simulation Details

Trawl Sector: Torres Strait; **Model:** Surplus Production Model – Fox without the $B_0 < K$ penalty (unconstrained); all data **Reference Points:** Limit 60% CPUE ; Upper – None.

Management Responses to Triggered Reference Points: For Limit reduce effort by 10%, compared to reduce effort by 30%.

(b) Biological Measures

Percentage effort reduction	Test Fishing Effort	5yr Probability $B_{t+5} < 20\%K$	20yr Probability $B_{t+20} < 20\%K$	5yr Probability $B_{t+5} < B_{MSY}$	20yr Probability $B_{t+20} < B_{MSY}$	5yr Biomass Ratio B_{t+5}/K	20yr Biomass Ratio B_{t+20}/K	5yr Biomass Ratio B_{t+5}/B_{MSY}	20yr Biomass Ratio B_{t+20}/B_{MSY}
10	12 000	0.00	0.00	0.13	0.09	0.41	0.41	1.06	1.08
10	10 000	0.00	0.00	0.02	0.08	0.46	0.41	1.19	1.08
10	8 000	0.00	0.00	0.00	0.01	0.52	0.46	1.35	1.20
10	6 000	0.00	0.00	0.00	0.00	0.59	0.55	1.54	1.43
10	4 000	0.00	0.00	0.00	0.00	0.67	0.65	1.75	1.69
30	12 000	0.00	0.00	0.06	0.01	0.42	0.46	1.11	1.19
30	10 000	0.00	0.00	0.02	0.01	0.46	0.46	1.19	1.21
30	8 000	0.00	0.00	0.00	0.01	0.52	0.46	1.35	1.20
30	6 000	0.00	0.00	0.00	0.00	0.59	0.55	1.54	1.43
30	4 000	0.00	0.00	0.00	0.00	0.67	0.65	1.75	1.69

(c) Fishing Industry Measures

Percentage effort reduction	Test Fishing Nights	5yr Catch (t)	20yr Catch (t)	5yr Catch Variation	20yr Catch Variation	5yr Fishing Nights	20yr Fishing Nights	5yr CPUE (kg/boat day)	20yr CPUE (kg/boat day)	5yr No. Limit Triggers	20yr No. Limit Triggers
10	12 000	744	697	0.07	0.05	11 697	9 631	58	70	0.6	2.4
10	10 000	689	689	0.01	0.01	10 688	9 720	65	70	0.0	0.9
10	8 000	611	648	0.04	0.04	8 737	8 747	73	78	0.0	0.1
10	6 000	516	577	0.09	0.08	6 821	6 798	83	92	0.0	0.0
10	4 000	399	473	0.13	0.11	4 860	4 862	94	109	0.0	0.0
30	12 000	740	676	0.08	0.07	11 467	8 864	60	77	0.5	1.0
30	10 000	689	682	0.01	0.02	10 673	7 608	65	78	0.0	0.7
30	8 000	611	648	0.04	0.04	8 734	8 748	73	78	0.0	0.0
30	6 000	516	577	0.09	0.08	6 810	6 800	83	92	0.0	0.0
30	4 000	400	473	0.13	0.11	4 862	4 866	94	109	0.0	0.0

Table 15.1.2.20 Performance of the 70% CPUE and one-way management responses measured against different biological and fishing industry objectives. Table (a) outlines the simulation details, Table (b) summaries the overfishing probabilities and expected median population sizes; the shaded cells indicated scenarios where 5-year biomass ratios B_{t+5}/B_{MSY} , are above one, and Table (c) summaries the expected median catch statistics and mean number of triggered reference points; the shaded cells highlight the scenarios that result in the best catches, lowest catch variation, highest fishing effort and catch rates, and the lowest number of catch-rate triggers.

(a) Simulation Details

Trawl Sector: Torres Strait; **Model:** Surplus Production Model – Fox without the $B_0 < K$ penalty (unconstrained); all data **Reference Points:** Limit 70% CPUE ; Upper – None.

Management Responses to Triggered Reference Points: For Limit reduce effort by 10%, compared to reduce effort by 30%.

(b) Biological Measures

Percentage effort reduction	Test Fishing Effort	5yr Probability $B_{t+5} < 20\%K$	20yr Probability $B_{t+20} < 20\%K$	5yr Probability $B_{t+5} < B_{MSY}$	20yr Probability $B_{t+20} < B_{MSY}$	5yr Biomass Ratio B_{t+5}/K	20yr Biomass Ratio B_{t+20}/K	5yr Biomass Ratio B_{t+5}/B_{MSY}	20yr Biomass Ratio B_{t+20}/B_{MSY}
10	12 000	0.00	0.00	0.01	0.00	0.47	0.48	1.22	1.25
10	10 000	0.00	0.00	0.00	0.00	0.47	0.48	1.24	1.24
10	8 000	0.00	0.00	0.00	0.00	0.52	0.48	1.36	1.25
10	6 000	0.00	0.00	0.00	0.00	0.59	0.55	1.54	1.43
10	4 000	0.00	0.00	0.00	0.00	0.67	0.65	1.75	1.70
30	12 000	0.00	0.00	0.00	0.00	0.51	0.53	1.34	1.38
30	10 000	0.00	0.00	0.00	0.00	0.50	0.51	1.31	1.34
30	8 000	0.00	0.00	0.00	0.00	0.52	0.51	1.35	1.34
30	6 000	0.00	0.00	0.00	0.00	0.59	0.55	1.54	1.43
30	4 000	0.00	0.00	0.00	0.00	0.67	0.65	1.76	1.69

(c) Fishing Industry Measures

Percentage effort reduction	Test Fishing Nights	5yr Catch (t)	20yr Catch (t)	5yr Catch Variation	20yr Catch Variation	5yr Fishing Nights	20yr Fishing Nights	5yr CPUE (kg/boat day)	20yr CPUE (kg/boat day)	5yr No. Limit Triggers	20yr No. Limit Triggers
10	12 000	670	656	0.14	0.07	9 228	8 176	66	81	3.1	4.5
10	10 000	670	657	0.04	0.02	9 695	7 946	67	81	1.2	3.0
10	8 000	612	644	0.04	0.04	8 724	7 988	73	81	0.3	1.1
10	6 000	516	577	0.09	0.08	6 792	6 794	83	92	0.2	0.4
10	4 000	401	473	0.13	0.11	4 865	4 851	94	109	0.2	0.3
30	12 000	631	636	0.18	0.09	8 737	6 281	72	89	1.4	2.0
30	10 000	645	625	0.10	0.06	7 605	7 485	70	87	0.9	1.3
30	8 000	615	639	0.04	0.04	8 746	6 251	73	85	0.2	0.9
30	6 000	518	578	0.09	0.08	6 792	6 811	83	92	0.2	0.3
30	4 000	401	473	0.13	0.11	4 868	4 863	94	109	0.2	0.3

Table 15.1.2.21 Performance of the 80% CPUE and one-way management responses measured against different biological and fishing industry objectives. Table (a) outlines the simulation details, Table (b) summaries the overfishing probabilities and expected median population sizes; the shaded cells indicated scenarios where 5-year biomass ratios B_{t+5}/B_{MSY} , are above one, and Table (c) summaries the expected median catch statistics and mean number of triggered reference points; the shaded cells highlight the scenarios that result in the best catches, lowest catch variation, highest fishing effort and catch rates, and the lowest number of catch-rate triggers.

(a) Simulation Details

Trawl Sector: Torres Strait; **Model:** Surplus Production Model – Fox without the $B_0 < K$ penalty (unconstrained); all data **Reference Points:** Limit 80% CPUE ; Upper – None.
Management Responses to Triggered Reference Points: For Limit reduce effort by 10%, compared to reduce effort by 30%.

(b) Biological Measures

Percentage effort reduction	Test Fishing Effort	5yr Probability $B_{t+5} < 20\%K$	20yr Probability $B_{t+20} < 20\%K$	5yr Probability $B_{t+5} < B_{MSY}$	20yr Probability $B_{t+20} < B_{MSY}$	5yr Biomass Ratio B_{t+5}/K	20yr Biomass Ratio B_{t+20}/K	5yr Biomass Ratio B_{t+5}/B_{MSY}	20yr Biomass Ratio B_{t+20}/B_{MSY}
10	12 000	0.00	0.00	0.01	0.00	0.48	0.54	1.25	1.42
10	10 000	0.00	0.00	0.00	0.00	0.53	0.54	1.38	1.42
10	8 000	0.00	0.00	0.00	0.00	0.55	0.54	1.44	1.41
10	6 000	0.00	0.00	0.00	0.00	0.60	0.55	1.56	1.45
10	4 000	0.00	0.00	0.00	0.00	0.67	0.65	1.76	1.70
30	12 000	0.00	0.00	0.00	0.00	0.58	0.58	1.53	1.52
30	10 000	0.00	0.00	0.00	0.00	0.57	0.60	1.50	1.57
30	8 000	0.00	0.00	0.00	0.00	0.57	0.58	1.48	1.52
30	6 000	0.00	0.00	0.00	0.00	0.60	0.56	1.58	1.46
30	4 000	0.00	0.00	0.00	0.00	0.68	0.65	1.77	1.70

(c) Fishing Industry Measures

Percentage effort reduction	Test Fishing Nights	5yr Catch (t)	20yr Catch (t)	5yr Catch Variation	20yr Catch Variation	5yr Fishing Nights	20yr Fishing Nights	5yr CPUE (kg/boat day)	20yr CPUE (kg/boat day)	5yr No. Limit Triggers	20yr No. Limit Triggers
10	12 000	648	602	0.12	0.08	8 309	6 618	68	93	4.8	7.5
10	10 000	592	598	0.07	0.04	7 209	6 480	74	92	4.2	5.9
10	8 000	568	596	0.05	0.04	7 762	6 501	77	92	2.3	3.9
10	6 000	509	571	0.12	0.09	6 674	6 574	84	94	1.4	1.8
10	4 000	395	470	0.17	0.12	4 820	4 819	95	109	1.2	1.4
30	12 000	516	553	0.14	0.08	6 130	6 109	82	99	3.1	3.4
30	10 000	531	562	0.06	0.06	7 240	5 249	80	103	2.3	3.2
30	8 000	539	556	0.18	0.09	6 204	6 085	79	99	1.8	2.3
30	6 000	499	571	0.21	0.11	6 725	6 670	85	94	1.2	1.5
30	4 000	386	469	0.24	0.14	4 835	4 839	95	110	1.1	1.3

15.1.3 Saucer Scallops

Table 15.1.3.1 Performance of the 80% CPUE reference point and heavy two-way management response measured against different biological and fishing industry objectives. Table (a) outlines the simulation details, Table (b) summaries the overfishing probabilities and expected median population sizes; the shaded cells indicated scenarios where 5-year biomass ratios B_{t+5}/B_{MSY} , are above one, and Table (c) summaries the expected median catch statistics and mean number of triggered catch-rate reference points; the shaded cells highlight the scenarios that result in the best catches, lowest catch variation, highest fishing effort and catch rates, and the lowest number of catch-rate triggers.

(a) Simulation Details

Trawl Sector: Saucer Scallop; **Model:** Monthly Age Structured; **Recruitment Assumption:** Beverton-Holt; **Reference Points:** Limit 80% CPUE; Upper 95 percentile. **Management Response to Triggered Reference Points:** For Limit, reduce fishing effort by 30%; For Upper, increase fishing effort by 15%. **Size Limits:** 1. Current – Jan to Apr 90mm and May to Dec 95mm; 2. 90mm all year; 3. 95mm all year; and 4. Old – Nov to Apr 90mm and May to Aug 95mm.

(b) Biological Measures

Size Limit	Test Fishing Nights	5yr Probability $B_{t+5} < 20\%K$	20yr Probability $B_{t+20} < 20\%K$	5yr Probability $B_{t+5} < B_{MSY}$	20yr Probability $B_{t+20} < B_{MSY}$	5yr Biomass Ratio B_{t+5}/K	20yr Biomass Ratio B_{t+20}/K	5yr Biomass Ratio B_{t+5}/B_{MSY}	20yr Biomass Ratio B_{t+20}/B_{MSY}
Current	15 000	<0.01	<0.01	0.2	0.05	0.52	0.75	1.28	1.81
Current	10 000	<0.01	<0.01	0.11	0.06	0.59	0.74	1.45	1.83
Current	5000	<0.01	<0.01	0.03	0.05	0.69	0.76	1.69	1.86
90 mm	15 000	<0.01	<0.01	0.28	0.07	0.50	0.73	1.17	1.72
90 mm	10 000	<0.01	<0.01	0.15	0.07	0.57	0.72	1.34	1.70
90 mm	5000	<0.01	<0.01	0.05	0.07	0.68	0.74	1.59	1.73
95 mm	15 000	<0.01	<0.01	0.17	0.04	0.54	0.77	1.32	1.88
95 mm	10 000	<0.01	<0.01	0.1	0.05	0.61	0.76	1.48	1.89
95 mm	5000	<0.01	<0.01	0.03	0.04	0.70	0.78	1.72	1.94
Old	15 000	<0.01	<0.01	0.23	0.06	0.51	0.72	1.25	1.78
Old	10 000	<0.01	<0.01	0.12	0.06	0.58	0.71	1.42	1.76
Old	5000	<0.01	<0.01	0.04	0.06	0.68	0.73	1.67	1.79

(c) Fishing Industry Measures

Size Limit	Test Fishing Nights	5yr Catch (t meat)	20yr Catch (t meat)	5yr Catch Variation	20yr Catch Variation	5yr Fishing Nights	20yr Fishing Nights	5yr CPUE (baskets/night)	20yr CPUE (baskets/night)	5yr No. Limit Triggers	20yr No. Limit Triggers	5yr No. Upper Triggers	20yr No. Upper Triggers
Current	15 000	383	334	0.91	1.26	5746	3268	10	14	2.8	6.2	0.2	1.5
Current	10 000	400	340	0.86	1.24	5300	3445	11	14	2.1	5.2	0.3	1.9
Current	5000	329	359	0.80	1.23	3752	3730	12	14	1.4	3.8	0.6	3.2
90 mm	15 000	383	349	0.91	1.22	5767	3343	10	15	2.8	6.2	0.1	1.6
90 mm	10 000	425	377	0.85	1.19	5368	3715	11	15	2.1	5.1	0.3	1.9
90 mm	5000	349	404	0.78	1.18	3805	4013	13	15	1.3	3.5	0.6	3.3
95 mm	15 000	365	319	0.93	1.30	5549	2897	9	14	3.0	6.5	0.1	1.4
95 mm	10 000	370	314	0.88	1.28	5104	2971	11	14	2.3	5.5	0.3	1.8
95 mm	5000	311	331	0.82	1.28	3638	3161	12	14	1.6	4.1	0.5	3.0
Old	15 000	422	366	0.90	1.21	7350	3734	9	14	2.6	6.0	0.2	1.6
Old	10000	448	410	0.83	1.19	5867	3945	10	13	2.0	4.9	0.4	2.0
Old	5000	351	426	0.77	1.18	3876	4303	12	13	1.2	3.4	0.7	3.4

Table 15.1.3.2 Performance of the 80% CPUE reference point and heavy one-way management response measured against different biological and fishing industry objectives. Table (a) outlines the simulation details, Table (b) summaries the overfishing probabilities and expected median population sizes; the shaded cells indicated scenarios where 5-year biomass ratios B_{t+5}/B_{MSY} , are above one, and Table (c) summaries the expected median catch statistics and mean number of triggered catch-rate reference points; the shaded cells highlight the scenarios that result in the best catches, lowest catch variation, highest fishing effort and catch rates, and the lowest number of catch-rate triggers.

(a) Simulation Details

Trawl Sector: Saucer Scallop; **Model:** Monthly Age Structured; **Recruitment Assumption:** Beverton-Holt; **Reference Points:** Limit 80% CPUE; No Upper. **Management Response to Triggered Reference Points:** For Limit, reduce fishing effort by 30%; No Upper, no increase in fishing effort. **Size Limits:** 1. Current – Jan to Apr 90mm and May to Dec 95mm; 2. 90mm all year; 3. 95mm all year; and 4. Old – Nov to Apr 90 mm and May to Aug 95 mm.

(b) Biological Measures

Size Limit	Test Fishing Nights	5yr Probability $B_{t+5} < 20\%K$	20yr Probability $B_{t+20} < 20\%K$	5yr Probability $B_{t+5} < B_{MSY}$	20yr Probability $B_{t+20} < B_{MSY}$	5yr Biomass Ratio B_{t+5}/K	20yr Biomass Ratio B_{t+20}/K	5yr Biomass Ratio B_{t+5}/B_{MSY}	20yr Biomass Ratio B_{t+20}/B_{MSY}
Current	15 000	<0.01	<0.01	0.2	0.02	0.52	0.78	1.28	1.93
Current	10 000	<0.01	<0.01	0.11	0.02	0.60	0.79	1.45	1.95
Current	5000	<0.01	<0.01	0.03	<0.01	0.70	0.84	1.69	2.08
90 mm	15 000	<0.01	<0.01	0.28	0.04	0.50	0.77	1.18	1.83
90 mm	10 000	<0.01	<0.01	0.15	0.02	0.57	0.78	1.35	1.84
90 mm	5000	<0.01	<0.01	0.05	<0.01	0.68	0.83	1.60	1.96
95 mm	15 000	<0.01	<0.01	0.17	0.02	0.54	0.80	1.32	1.97
95 mm	10 000	<0.01	<0.01	0.09	0.01	0.61	0.81	1.48	2.00
95 mm	5000	<0.01	<0.01	0.03	<0.01	0.71	0.86	1.72	2.12
Old	15 000	<0.01	<0.01	0.23	0.03	0.51	0.76	1.25	1.88
Old	10 000	<0.01	<0.01	0.12	0.02	0.58	0.77	1.42	1.91
Old	5000	<0.01	<0.01	0.04	<0.01	0.68	0.83	1.67	2.05

(c) Fishing Industry Measures

Size Limit	Test Fishing Nights	5yr Catch (t meat)	20yr Catch (t meat)	5yr Catch Variation	20yr Catch Variation	5yr Fishing Nights	20yr Fishing Nights	5yr CPUE (baskets/night)	20yr CPUE (baskets/night)	5yr No. Limit Triggers	20yr No. Limit Triggers
Current	15 000	383	288	0.86	1.19	5746	2682	10	15	2.8	6.2
Current	10 000	400	307	0.79	1.08	5300	2847	11	15	2.1	5.1
Current	5000	329	308	0.70	0.93	3705	2782	12	16	1.4	3.7
90 mm	15 000	383	301	0.86	1.17	5767	2691	10	16	2.8	6.1
90 mm	10 000	425	324	0.78	1.06	5368	2927	11	16	2.1	4.9
90 mm	5000	349	334	0.67	0.90	3759	2902	13	17	1.3	3.5
95 mm	15 000	365	267	0.87	1.21	5549	2521	9	15	3.0	6.4
95 mm	10 000	370	278	0.81	1.12	5104	2563	11	15	2.3	5.4
95 mm	5000	311	283	0.73	0.97	3607	2532	12	16	1.6	4.0
Old	15 000	422	323	0.84	1.15	7350	3041	9	15	2.6	5.9
Old	10 000	448	334	0.76	1.05	5867	3430	10	15	2.0	4.8
Old	5000	351	338	0.66	0.89	3796	3076	12	16	1.2	3.3

Table 15.1.3.3 Performance of the 80% CPUE reference point and moderate two-way management response measured against different biological and fishing industry objectives. Table (a) outlines the simulation details, Table (b) summaries the overfishing probabilities and expected median population sizes; the shaded cells indicated scenarios where 5-year biomass ratios B_{t+5}/B_{MSY} , are above one, and Table (c) summaries the expected median catch statistics and mean number of triggered catch-rate reference points; the shaded cells highlight the scenarios that result in the best catches, lowest catch variation, highest fishing effort and catch rates, and the lowest number of catch-rate triggers.

(a) Simulation Details

Trawl Sector: Saucer Scallop; **Model:** Monthly Age Structured; **Recruitment Assumption:** Beverton-Holt; **Reference Points:** Limit 80% CPUE; Upper 95 percentile. **Management Response to Triggered Reference Points:** For Limit, reduce fishing effort by 10%; For Upper, increase fishing effort by 5%. **Size Limits:** 1. Current – Jan to Apr 90 mm and May to Dec 95 mm; 2. 90 mm all year; 3. 95 mm all year; and 4. Old – Nov to Apr 90 mm and May to Aug 95 mm.

(b) Biological Measures

Size Limit	Test Fishing Nights	5yr Probability $B_{t+5} < 20\%K$	20yr Probability $B_{t+20} < 20\%K$	5yr Probability $B_{t+5} < B_{MSY}$	20yr Probability $B_{t+20} < B_{MSY}$	5yr Biomass Ratio B_{t+5}/K	20yr Biomass Ratio B_{t+20}/K	5yr Biomass Ratio B_{t+5}/B_{MSY}	20yr Biomass Ratio B_{t+20}/B_{MSY}
Current	15 000	0.01	<0.01	0.37	0.15	0.46	0.59	1.10	1.44
Current	10 000	<0.01	<0.01	0.17	0.08	0.55	0.65	1.33	1.58
Current	5000	<0.01	<0.01	0.05	0.01	0.67	0.74	1.64	1.83
90 mm	15 000	0.01	0.01	0.49	0.2	0.44	0.57	1.01	1.34
90 mm	10 000	<0.01	<0.01	0.24	0.11	0.53	0.62	1.24	1.47
90 mm	5000	<0.01	<0.01	0.07	0.03	0.66	0.72	1.55	1.71
95 mm	15 000	0.01	<0.01	0.35	0.13	0.46	0.60	1.13	1.49
95 mm	10 000	<0.01	<0.01	0.16	0.06	0.55	0.66	1.35	1.63
95 mm	5000	<0.01	<0.01	0.04	0.01	0.68	0.76	1.67	1.89
Old	15 000	0.01	<0.01	0.4	0.18	0.44	0.56	1.08	1.40
Old	10 000	<0.01	<0.01	0.19	0.09	0.53	0.62	1.31	1.53
Old	5000	<0.01	<0.01	0.05	0.02	0.66	0.72	1.63	1.79

(c) Fishing Industry Measures

Size Limit	Test Fishing Nights	5yr Catch (t meat)	20yr Catch (t meat)	5yr Catch Variation	20yr Catch Variation	5yr Fishing Nights	20yr Fishing Nights	5yr CPUE (baskets/night)	20yr CPUE (baskets/night)	5yr No. Limit Triggers	20yr No. Limit Triggers	5yr No. Upper Triggers	20yr No. Upper Triggers
Current	15 000	623	482	0.64	1.03	11 693	5811	8	12	3.3	9.6	0.1	0.8
Current	10 000	557	492	0.61	1.00	8524	5824	10	12	2.5	7.3	0.3	1.6
Current	5000	392	436	0.58	0.95	4784	4640	12	14	1.5	4.6	0.6	3.5
90 mm	15 000	624	488	0.64	1.02	11 752	5811	8	12	3.3	9.7	0.1	0.8
90 mm	10 000	575	513	0.61	0.98	8612	5843	10	13	2.4	7.3	0.3	1.6
90 mm	5000	413	457	0.58	0.93	4851	4741	13	15	1.4	4.4	0.6	3.6
95 mm	15 000	620	457	0.64	1.04	11 466	5407	8	12	3.4	9.9	0.1	0.7
95 mm	10 000	547	473	0.62	1.02	8297	5314	10	12	2.7	7.7	0.2	1.4
95 mm	5000	385	418	0.59	0.97	4653	4256	12	14	1.7	5.1	0.5	3.1
Old	15 000	630	508	0.64	1.01	12 071	6391	8	11	3.1	9.2	0.1	0.9
Old	10 000	575	520	0.61	0.98	8902	6214	10	12	2.3	6.9	0.3	1.8
Old	5000	401	458	0.57	0.93	4925	4960	12	14	1.3	4.2	0.7	3.8

Table 15.1.3.4 Performance of the 80% CPUE reference point and moderate one-way management response measured against different biological and fishing industry objectives. Table (a) outlines the simulation details, Table (b) summaries the overfishing probabilities and expected median population sizes; the shaded cells indicated scenarios where 5-year biomass ratios B_{t+5}/B_{MSY} , are above one, and Table (c) summaries the expected median catch statistics and mean number of triggered catch-rate reference points; the shaded cells highlight the scenarios that result in the best catches, lowest catch variation, highest fishing effort and catch rates, and the lowest number of catch-rate triggers.

(a) Simulation Details

Trawl Sector: Saucer Scallop; **Model:** Monthly Age Structured; **Recruitment Assumption:** Beverton-Holt; **Reference Points:** Limit 80% CPUE; No Upper.
Management Response to Triggered Reference Points: For Limit, reduce fishing effort by 10%; No Upper, no increase in fishing effort.
Size Limits: 1. Current – Jan to Apr 90 mm and May to Dec 95 mm; 2. 90 mm all year; 3. 95 mm all year; and 4. Old – Nov to Apr 90 mm and May to Aug 95 mm.

(b) Biological Measures

Size Limit	Test Fishing Nights	5yr Probability $B_{t+5} < 20\%K$	20yr Probability $B_{t+20} < 20\%K$	5yr Probability $B_{t+5} < B_{MSY}$	20yr Probability $B_{t+20} < B_{MSY}$	5yr Biomass Ratio B_{t+5}/K	20yr Biomass Ratio B_{t+20}/K	5yr Biomass Ratio B_{t+5}/B_{MSY}	20yr Biomass Ratio B_{t+20}/B_{MSY}
Current	15 000	0.01	<0.01	0.37	0.14	0.46	0.59	1.10	1.47
Current	10 000	<0.01	<0.01	0.17	0.06	0.55	0.66	1.34	1.62
Current	5000	<0.01	<0.01	0.05	0.01	0.67	0.78	1.64	1.90
90 mm	15 000	0.01	0.01	0.49	0.18	0.44	0.58	1.01	1.36
90 mm	10 000	<0.01	<0.01	0.24	0.08	0.53	0.64	1.24	1.50
90 mm	5000	<0.01	<0.01	0.07	0.02	0.66	0.76	1.55	1.79
95 mm	15 000	0.01	<0.01	0.35	0.12	0.46	0.61	1.13	1.51
95 mm	10 000	<0.01	<0.01	0.16	0.05	0.55	0.68	1.35	1.67
95 mm	5000	<0.01	<0.01	0.04	0.01	0.68	0.78	1.67	1.94
Old	15 000	0.01	<0.01	0.4	0.17	0.44	0.57	1.08	1.43
Old	10 000	<0.01	<0.01	0.19	0.07	0.53	0.64	1.31	1.57
Old	5000	<0.01	<0.01	0.05	0.01	0.66	0.76	1.63	1.88

(c) Fishing Industry Measures

Size Limit	Test Fishing Nights	5yr Catch (t meat)	20yr Catch (t meat)	5yr Catch Variation	20yr Catch Variation	5yr Fishing Nights	20yr Fishing Nights	5yr CPUE (baskets/night)	20yr CPUE (baskets/night)	5yr No. Limit Triggers	20yr No. Limit Triggers
Current	15 000	623	479	0.62	0.95	11 693	5811	8	12	3.3	9.6
Current	10 000	557	491	0.59	0.87	8524	5675	10	13	2.5	7.3
Current	5000	392	416	0.55	0.75	4747	4338	12	15	1.5	4.6
90 mm	15 000	624	488	0.63	0.95	11 752	5801	8	13	3.3	9.7
90 mm	10 000	575	509	0.59	0.86	8612	5674	10	13	2.4	7.3
90 mm	5000	411	438	0.54	0.74	4821	4428	13	16	1.4	4.4
95 mm	15 000	620	452	0.62	0.96	11 466	5373	8	12	3.4	9.9
95 mm	10 000	547	469	0.60	0.88	8297	5314	10	13	2.7	7.7
95 mm	5000	385	399	0.56	0.77	4630	4050	12	15	1.7	5.0
Old	15 000	630	506	0.62	0.93	12 071	6367	8	12	3.1	9.2
Old	10 000	575	513	0.58	0.85	8902	6012	10	12	2.3	6.9
Old	5000	401	442	0.54	0.73	4876	4500	12	15	1.3	4.2

Table 15.1.3.5 Performance of the 80% CPUE reference point and heavy two-way management response measured against different biological and fishing industry objectives. Table (a) outlines the simulation details, Table (b) summaries the overfishing probabilities and expected median population sizes; the shaded cells indicated scenarios where 5-year biomass ratios B_{t+5}/B_{MSY} , are above one, and Table (c) summaries the expected median catch statistics and mean number of triggered catch-rate reference points; the shaded cells highlight the scenarios that result in the best catches, lowest catch variation, highest fishing effort and catch rates, and the lowest number of catch-rate triggers.

(a) Simulation Details

Trawl Sector: Saucer Scallop; **Model:** Monthly Age Structured; **Recruitment Assumption:** Ricker; **Reference Points:** Limit 80% CPUE; Upper 95 percentile.
Management Response to Triggered Reference Points: For Limit, reduce fishing effort by 30%; For Upper, increase fishing effort by 15%.
Size Limits: 1. Current – Jan to Apr 90 mm and May to Dec 95 mm; 2. 90 mm all year; 3. 95 mm all year; and 4. Old – Nov to Apr 90 mm and May to Aug 95 mm.

(b) Biological Measures

Size Limit	Test Fishing Nights	5yr Probability $B_{t+5} < 20\%K$	20yr Probability $B_{t+20} < 20\%K$	5yr Probability $B_{t+5} < B_{MSY}$	20yr Probability $B_{t+20} < B_{MSY}$	5yr Biomass Ratio B_{t+5}/K	20yr Biomass Ratio B_{t+20}/K	5yr Biomass Ratio B_{t+5}/B_{MSY}	20yr Biomass Ratio B_{t+20}/B_{MSY}
Current	15 000	<0.01	<0.01	0.38	0.11	0.51	0.76	1.12	1.67
Current	10 000	<0.01	<0.01	0.24	0.12	0.58	0.75	1.28	1.65
Current	5000	<0.01	<0.01	0.1	0.11	0.68	0.76	1.49	1.68
90 mm	15 000	<0.01	<0.01	0.46	0.13	0.49	0.75	1.03	1.59
90 mm	10 000	<0.01	<0.01	0.32	0.14	0.56	0.73	1.19	1.56
90 mm	5000	<0.01	<0.01	0.13	0.14	0.67	0.74	1.41	1.57
95 mm	15 000	<0.01	<0.01	0.34	0.09	0.53	0.78	1.16	1.72
95 mm	10 000	<0.01	<0.01	0.22	0.09	0.60	0.77	1.31	1.72
95 mm	5000	<0.01	<0.01	0.09	0.09	0.70	0.79	1.53	1.74
Old	15 000	<0.01	<0.01	0.41	0.13	0.49	0.73	1.09	1.62
Old	10 000	<0.01	<0.01	0.25	0.14	0.56	0.72	1.24	1.57
Old	5000	<0.01	<0.01	0.11	0.13	0.67	0.73	1.47	1.61

(c) Fishing Industry Measures

Size Limit	Test Fishing Nights	5yr Catch (t meat)	20yr Catch (t meat)	5yr Catch Variation	20yr Catch Variation	5yr Fishing Nights	20yr Fishing Nights	5yr CPUE (baskets/night)	20yr CPUE (baskets/night)	5yr No. Limit Triggers	20yr No. Limit Triggers	5yr No. Upper Triggers	20yr No. Upper Triggers
Current	15 000	380	290	0.83	1.23	5634	2966	9	14	2.9	6.6	0.1	1.6
Current	10 000	401	333	0.80	1.18	5309	3344	11	13	2.2	5.4	0.2	1.9
Current	5000	322	340	0.76	1.19	3685	3540	12	14	1.5	4.0	0.5	3.2
90 mm	15 000	387	314	0.83	1.19	5722	3106	10	15	3.0	6.6	0.1	1.7
90 mm	10 000	418	356	0.79	1.14	5348	3506	11	14	2.2	5.3	0.2	1.9
90 mm	5000	342	384	0.75	1.13	3757	3829	13	15	1.4	3.8	0.5	3.2
95 mm	15 000	347	272	0.84	1.27	5500	2649	9	14	3.1	6.8	0.1	1.5
95 mm	10 000	373	296	0.82	1.23	5075	2891	11	14	2.4	5.7	0.2	1.8
95 mm	5000	306	306	0.78	1.24	3585	2942	12	14	1.6	4.3	0.4	2.9
Old	15 000	406	323	0.81	1.18	6010	3184	9	13	2.8	6.3	0.1	1.7
Old	10 000	431	365	0.77	1.13	5575	3740	10	13	2.1	5.1	0.2	2.0
Old	5000	343	390	0.73	1.13	3809	4279	12	13	1.3	3.7	0.5	3.3

Table 15.1.3.6 Performance of the 80% CPUE reference point and heavy one-way management response measured against different biological and fishing industry objectives. Table (a) outlines the simulation details, Table (b) summaries the overfishing probabilities and expected median population sizes; the shaded cells indicated scenarios where 5-year biomass ratios B_{t+5}/B_{MSY} , are above one, and Table (c) summaries the expected median catch statistics and mean number of triggered catch-rate reference points; the shaded cells highlight the scenarios that result in the best catches, lowest catch variation, highest fishing effort and catch rates, and the lowest number of catch-rate triggers.

(a) Simulation Details

Trawl Sector: Saucer Scallop; **Model:** Monthly Age Structured; **Recruitment Assumption:** Ricker; **Reference Points:** Limit 80% CPUE; No Upper.
Management Response to Triggered Reference Points: For Limit, reduce fishing effort by 30%; No Upper, no increase in fishing effort.
Size Limits: 1. Current – Jan to Apr 90 mm and May to Dec 95 mm; 2. 90 mm all year; 3. 95 mm all year; and 4. Old – Nov to Apr 90 mm and May to Aug 95 mm.

(b) Biological Measures

Size Limit	Test Fishing Nights	5yr Probability $B_{t+5} < 20\%K$	20yr Probability $B_{t+20} < 20\%K$	5yr Probability $B_{t+5} < B_{MSY}$	20yr Probability $B_{t+20} < B_{MSY}$	5yr Biomass Ratio B_{t+5}/K	20yr Biomass Ratio B_{t+20}/K	5yr Biomass Ratio B_{t+5}/B_{MSY}	20yr Biomass Ratio B_{t+20}/B_{MSY}
Current	15 000	<0.01	<0.01	0.38	0.05	0.51	0.79	1.12	1.73
Current	10 000	<0.01	<0.01	0.24	0.04	0.59	0.79	1.28	1.76
Current	5000	<0.01	<0.01	0.1	<0.01	0.68	0.85	1.50	1.87
90 mm	15 000	<0.01	<0.01	0.46	0.07	0.49	0.78	1.03	1.67
90 mm	10 000	<0.01	<0.01	0.32	0.06	0.56	0.78	1.19	1.66
90 mm	5000	<0.01	<0.01	0.13	0.01	0.67	0.84	1.41	1.79
95 mm	15 000	<0.01	<0.01	0.34	0.04	0.53	0.81	1.16	1.79
95 mm	10 000	<0.01	<0.01	0.22	0.04	0.60	0.82	1.31	1.80
95 mm	5000	<0.01	<0.01	0.09	<0.01	0.70	0.87	1.54	1.91
Old	15 000	<0.01	<0.01	0.41	0.06	0.49	0.77	1.09	1.70
Old	10 000	<0.01	<0.01	0.25	0.06	0.56	0.77	1.25	1.73
Old	5000	<0.01	<0.01	0.1	0.01	0.67	0.83	1.48	1.84

(c) Fishing Industry Measures

Size Limit	Test Fishing Nights	5yr Catch (t meat)	20yr Catch (t meat)	5yr Catch Variation	20yr Catch Variation	5yr Fishing Nights	20yr Fishing Nights	5yr CPUE (baskets/night)	20yr CPUE (baskets/night)	5yr No. Limit Triggers	20yr No. Limit Triggers
Current	15 000	380	259	0.80	1.21	5634	2521	9	15	2.9	6.5
Current	10 000	401	286	0.75	1.12	5300	2665	11	15	2.2	5.3
Current	5000	322	286	0.68	0.96	3653	2600	12	16	1.5	3.9
90 mm	15 000	387	271	0.80	1.20	5722	2521	10	16	3.0	6.5
90 mm	10 000	415	308	0.74	1.10	5344	2679	11	16	2.2	5.2
90 mm	5000	341	318	0.66	0.93	3701	2720	13	17	1.4	3.7
95 mm	15 000	347	231	0.82	1.24	5500	1998	9	14	3.1	6.7
95 mm	10 000	373	256	0.78	1.15	5074	2430	11	15	2.4	5.6
95 mm	5000	305	246	0.71	1.00	3559	2450	12	15	1.6	4.3
Old	15 000	406	276	0.78	1.18	6010	2599	9	15	2.8	6.3
Old	10 000	431	314	0.72	1.08	5570	2842	10	14	2.1	5.0
Old	5000	341	328	0.65	0.92	3764	2912	12	16	1.3	3.6

Table 15.1.3.7 Performance of the 80% CPUE reference point and moderate two-way management response measured against different biological and fishing industry objectives. Table (a) outlines the simulation details, Table (b) summaries the overfishing probabilities and expected median population sizes; the shaded cells indicated scenarios where 5-year biomass ratios B_{t+5}/B_{MSY} , are above one, and Table (c) summaries the expected median catch statistics and mean number of triggered catch-rate reference points; the shaded cells highlight the scenarios that result in the best catches, lowest catch variation, highest fishing effort and catch rates, and the lowest number of catch-rate triggers.

(a) Simulation Details

Trawl Sector: Saucer Scallop; **Model:** Monthly Age Structured; **Recruitment Assumption:** Ricker; **Reference Points:** Limit 80% CPUE; Upper 95 percentile.
Management Response to Triggered Reference Points: For Limit, reduce fishing effort by 10%; For Upper, increase fishing effort by 5%.
Size Limits: 1. Current – Jan to Apr 90 mm and May to Dec 95 mm; 2. 90 mm all year; 3. 95 mm all year; and 4. Old – Nov to Apr 90 mm and May to Aug 95 mm.

(b) Biological Measures

Size Limit	Test Fishing Nights	5yr Probability $B_{t+5} < 20\%K$	20yr Probability $B_{t+20} < 20\%K$	5yr Probability $B_{t+5} < B_{MSY}$	20yr Probability $B_{t+20} < B_{MSY}$	5yr Biomass Ratio B_{t+5}/K	20yr Biomass Ratio B_{t+20}/K	5yr Biomass Ratio B_{t+5}/B_{MSY}	20yr Biomass Ratio B_{t+20}/B_{MSY}
Current	15 000	0.01	<0.01	0.53	0.26	0.44	0.58	0.97	1.28
Current	10 000	<0.01	<0.01	0.34	0.16	0.54	0.63	1.18	1.41
Current	5000	<0.01	<0.01	0.12	0.04	0.66	0.74	1.45	1.64
90 mm	15 000	0.02	0.01	0.62	0.33	0.42	0.55	0.90	1.18
90 mm	10 000	<0.01	<0.01	0.41	0.2	0.52	0.62	1.10	1.30
90 mm	5000	<0.01	<0.01	0.16	0.07	0.65	0.72	1.37	1.55
95 mm	15 000	<0.01	<0.01	0.52	0.23	0.45	0.59	0.99	1.31
95 mm	10 000	<0.01	<0.01	0.31	0.14	0.54	0.65	1.19	1.45
95 mm	5000	<0.01	<0.01	0.11	0.04	0.67	0.76	1.47	1.69
Old	15 000	0.01	<0.01	0.56	0.29	0.43	0.55	0.95	1.23
Old	10 000	<0.01	<0.01	0.35	0.19	0.52	0.61	1.15	1.35
Old	5000	<0.01	<0.01	0.13	0.05	0.65	0.72	1.43	1.62

(c) Fishing Industry Measures

Size Limit	Test Fishing Nights	5yr Catch (t meat)	20yr Catch (t meat)	5yr Catch Variation	20yr Catch Variation	5yr Fishing Nights	20yr Fishing Nights	5yr CPUE (baskets/night)	20yr CPUE (baskets/night)	5yr No. Limit Triggers	20yr No. Limit Triggers	5yr No. Upper Triggers	20yr No. Upper Triggers
Current	15 000	608	412	0.57	1.01	11 565	5121	8	11	3.4	10.2	0.1	0.7
Current	10 000	553	450	0.56	1.00	8512	5343	10	12	2.5	7.7	0.2	1.5
Current	5000	390	415	0.55	0.97	4733	4500	12	14	1.6	4.8	0.4	3.4
90 mm	15 000	610	408	0.58	1.00	11 651	4926	8	12	3.5	10.4	0.1	0.7
90 mm	10 000	562	441	0.56	0.99	8581	5314	10	13	2.5	7.8	0.2	1.5
90 mm	5000	409	442	0.54	0.95	4795	4594	13	15	1.5	4.6	0.5	3.5
95 mm	15 000	602	397	0.57	1.02	11 364	4864	8	11	3.6	10.5	0.1	0.6
95 mm	10 000	543	429	0.57	1.02	8251	4978	9	12	2.7	8.1	0.1	1.3
95 mm	5000	386	392	0.55	0.99	4632	4253	12	14	1.7	5.2	0.4	3.1
Old	15 000	619	423	0.57	1.00	11 942	5367	8	11	3.3	9.9	0.1	0.8
Old	10 000	564	456	0.56	0.98	8870	5592	9	12	2.3	7.3	0.2	1.6
Old	5000	400	438	0.54	0.95	4863	4756	12	14	1.4	4.4	0.5	3.7

Table 15.1.3.8 Performance of the 80% CPUE reference point and moderate one-way management response measured against different biological and fishing industry objectives. Table (a) outlines the simulation details, Table (b) summaries the overfishing probabilities and expected median population sizes; the shaded cells indicated scenarios where 5-year biomass ratios B_{t+5}/B_{MSY} , are above one, and Table (c) summaries the expected median catch statistics and mean number of triggered catch-rate reference points; the shaded cells highlight the scenarios that result in the best catches, lowest catch variation, highest fishing effort and catch rates, and the lowest number of catch-rate triggers.

(a) Simulation Details

Trawl Sector: Saucer Scallop; **Model:** Monthly Age Structured; **Recruitment Assumption:** Ricker; **Reference Points:** Limit 80% CPUE; No Upper.
Management Response to Triggered Reference Points: For Limit, reduce fishing effort by 10%; No Upper, no increase in fishing effort.
Size Limits: 1. Current – Jan to Apr 90 mm and May to Dec 95 mm; 2. 90 mm all year; 3. 95 mm all year; and 4. Old – Nov to Apr 90 mm and May to Aug 95 mm.

(b) Biological Measures

Size Limit	Test Fishing Nights	5yr Probability $B_{t+5} < 20\%K$	20yr Probability $B_{t+20} < 20\%K$	5yr Probability $B_{t+5} < B_{MSY}$	20yr Probability $B_{t+20} < B_{MSY}$	5yr Biomass Ratio B_{t+5}/K	20yr Biomass Ratio B_{t+20}/K	5yr Biomass Ratio B_{t+5}/B_{MSY}	20yr Biomass Ratio B_{t+20}/B_{MSY}
Current	15 000	0.01	<0.01	0.53	0.24	0.44	0.59	0.97	1.30
Current	10 000	<0.01	<0.01	0.34	0.13	0.54	0.66	1.18	1.44
Current	5000	<0.01	<0.01	0.12	0.02	0.66	0.78	1.45	1.71
90 mm	15 000	0.02	0.01	0.62	0.32	0.42	0.56	0.90	1.20
90 mm	10 000	<0.01	<0.01	0.4	0.17	0.52	0.64	1.10	1.34
90 mm	5000	<0.01	<0.01	0.16	0.04	0.65	0.77	1.37	1.63
95 mm	15 000	<0.01	<0.01	0.52	0.22	0.45	0.60	0.99	1.34
95 mm	10 000	<0.01	<0.01	0.31	0.12	0.54	0.68	1.19	1.48
95 mm	5000	<0.01	<0.01	0.11	0.02	0.67	0.79	1.48	1.75
Old	15 000	0.01	<0.01	0.56	0.27	0.43	0.56	0.95	1.25
Old	10 000	<0.01	<0.01	0.35	0.16	0.52	0.64	1.15	1.40
Old	5000	<0.01	<0.01	0.13	0.03	0.65	0.76	1.43	1.69

(c) Fishing Industry Measures

Size Limit	Test Fishing Nights	5yr Catch (t meat)	20yr Catch (t meat)	5yr Catch Variation	20yr Catch Variation	5yr Fishing Nights	20yr Fishing Nights	5yr CPUE (baskets/night)	20yr CPUE (baskets/night)	5yr No. Limit Triggers	20yr No. Limit Triggers
Current	15 000	608	411	0.57	0.97	11 565	5112	8	11	3.4	10.2
Current	10 000	553	446	0.55	0.90	8512	5314	10	12	2.5	7.7
Current	5000	390	398	0.52	0.78	4712	4173	12	14	1.6	4.8
90 mm	15 000	610	408	0.57	0.97	11 651	4899	8	12	3.5	10.4
90 mm	10 000	562	441	0.55	0.90	8573	5314	10	13	2.5	7.7
90 mm	5000	409	423	0.52	0.76	4752	4217	13	15	1.5	4.6
95 mm	15 000	602	397	0.57	0.98	11 364	4795	8	11	3.6	10.5
95 mm	10 000	543	427	0.56	0.92	8251	4932	9	12	2.7	8.1
95 mm	5000	386	381	0.53	0.80	4618	4050	12	14	1.7	5.2
Old	15 000	619	420	0.57	0.96	11 942	5308	8	11	3.3	9.9
Old	10 000	564	453	0.54	0.88	8870	5514	9	12	2.3	7.3
Old	5000	400	419	0.51	0.76	4835	4473	12	14	1.4	4.4

Table 15.1.3.9 Performance of the 70% CPUE reference point and heavy two-way management response measured against different biological and fishing industry objectives. Table (a) outlines the simulation details, Table (b) summaries the overfishing probabilities and expected median population sizes; the shaded cells indicated scenarios where 5-year biomass ratios B_{t+5}/B_{MSY} , are above one, and Table (c) summaries the expected median catch statistics and mean number of triggered catch-rate reference points; the shaded cells highlight the scenarios that result in the best catches, lowest catch variation, highest fishing effort and catch rates, and the lowest number of catch-rate triggers.

(a) Simulation Details

Trawl Sector: Saucer Scallop; **Model:** Monthly Age Structured; **Recruitment Assumption:** Beverton-Holt; **Reference Points:** Limit 70% CPUE; Upper 95 percentile.
Management Response to Triggered Reference Points: For Limit, reduce fishing effort by 30%; For Upper, increase fishing effort by 15%.
Size Limits: 1. Current – Jan to Apr 90 mm and May to Dec 95 mm; 2. 90 mm all year; 3. 95 mm all year; and 4. Old – Nov to Apr 90 mm and May to Aug 95 mm.

(b) Biological Measures

Size Limit	Test Fishing Nights	5yr Probability $B_{t+5} < 20\%K$	20yr Probability $B_{t+20} < 20\%K$	5yr Probability $B_{t+5} < B_{MSY}$	20yr Probability $B_{t+20} < B_{MSY}$	5yr Biomass Ratio B_{t+5}/K	20yr Biomass Ratio B_{t+20}/K	5yr Biomass Ratio B_{t+5}/B_{MSY}	20yr Biomass Ratio B_{t+20}/B_{MSY}
Current	15 000	<0.01	<0.01	0.29	0.07	0.49	0.69	1.20	1.70
Current	10 000	<0.01	<0.01	0.14	0.08	0.56	0.68	1.37	1.70
Current	5000	<0.01	<0.01	0.04	0.06	0.67	0.72	1.64	1.77
90 mm	15 000	<0.01	<0.01	0.39	0.09	0.47	0.68	1.10	1.61
90 mm	10 000	<0.01	<0.01	0.21	0.11	0.54	0.67	1.27	1.59
90 mm	5000	<0.01	<0.01	0.06	0.08	0.66	0.70	1.55	1.64
95 mm	15 000	<0.01	<0.01	0.26	0.06	0.51	0.72	1.24	1.77
95 mm	10 000	<0.01	<0.01	0.13	0.06	0.58	0.71	1.41	1.76
95 mm	5000	<0.01	<0.01	0.04	0.05	0.68	0.75	1.67	1.84
Old	15 000	<0.01	<0.01	0.32	0.09	0.47	0.67	1.16	1.65
Old	10 000	<0.01	<0.01	0.16	0.09	0.55	0.65	1.34	1.64
Old	5000	<0.01	<0.01	0.05	0.07	0.66	0.69	1.63	1.70

(c) Fishing Industry Measures

Size Limit	Test Fishing Nights	5yr Catch (t meat)	20yr Catch (t meat)	5yr Catch Variation	20yr Catch Variation	5yr Fishing Nights	20yr Fishing Nights	5yr CPUE (baskets/night)	20yr CPUE (baskets/night)	5yr No. Limit Triggers	20yr No. Limit Triggers	5yr No. Upper Triggers	20yr No. Upper Triggers
Current	15 000	488	419	0.83	1.18	8051	4240	9	13	2.3	5.4	0.1	1.0
Current	10 000	526	425	0.77	1.15	7476	4900	10	13	1.6	4.3	0.3	1.4
Current	5000	395	450	0.71	1.14	5096	5000	12	13	0.9	2.8	0.6	2.7
90 mm	15 000	488	425	0.83	1.15	8077	4337	9	14	2.4	5.4	0.1	1.0
90 mm	10 000	541	448	0.76	1.11	7544	4926	10	13	1.6	4.2	0.3	1.4
90 mm	5000	415	478	0.70	1.09	5164	5163	13	14	0.8	2.6	0.6	2.8
95 mm	15 000	469	374	0.85	1.21	7776	3871	9	13	2.5	5.7	0.1	0.9
95 mm	10 000	501	396	0.79	1.18	7243	4105	10	13	1.8	4.5	0.2	1.3
95 mm	5000	385	427	0.73	1.18	5000	4313	12	13	1.0	3.1	0.5	2.5
Old	15 000	527	440	0.81	1.14	10 096	4970	9	12	2.2	5.2	0.1	1.0
Old	10 000	543	473	0.75	1.12	7751	5467	10	12	1.5	4.0	0.3	1.5
Old	5000	406	491	0.69	1.10	5205	5485	12	13	0.8	2.5	0.6	3.0

Table 15.1.3.10 Performance of the 70% CPUE reference point and heavy one-way management response measured against different biological and fishing industry objectives. Table (a) outlines the simulation details, Table (b) summaries the overfishing probabilities and expected median population sizes; the shaded cells indicated scenarios where 5-year biomass ratios B_{t+5}/B_{MSY} , are above one, and Table (c) summaries the expected median catch statistics and mean number of triggered catch-rate reference points; the shaded cells highlight the scenarios that result in the best catches, lowest catch variation, highest fishing effort and catch rates, and the lowest number of catch-rate triggers.

(a) Simulation Details

Trawl Sector: Saucer Scallop; **Model:** Monthly Age Structured; **Recruitment Assumption:** Beverton-Holt; **Reference Points:** Limit 70% CPUE; No Upper.
Management Response to Triggered Reference Points: For Limit, reduce fishing effort by 30%; No Upper, no increase in fishing effort.
Size Limits: 1. Current – Jan to Apr 90 mm and May to Dec 95 mm; 2. 90 mm all year; 3. 95 mm all year; and 4. Old – Nov to Apr 90 mm and May to Aug 95 mm.

(b) Biological Measures

Size Limit	Test Fishing Nights	5yr Probability $B_{t+5} < 20\%K$	20yr Probability $B_{t+20} < 20\%K$	5yr Probability $B_{t+5} < B_{MSY}$	20yr Probability $B_{t+20} < B_{MSY}$	5yr Biomass Ratio B_{t+5}/K	20yr Biomass Ratio B_{t+20}/K	5yr Biomass Ratio B_{t+5}/B_{MSY}	20yr Biomass Ratio B_{t+20}/B_{MSY}
Current	15 000	<0.01	<0.01	0.29	0.05	0.49	0.72	1.20	1.77
Current	10 000	<0.01	<0.01	0.14	0.04	0.56	0.73	1.37	1.80
Current	5000	<0.01	<0.01	0.04	<0.01	0.67	0.80	1.65	1.97
90 mm	15 000	<0.01	<0.01	0.39	0.07	0.47	0.71	1.10	1.68
90 mm	10 000	<0.01	<0.01	0.21	0.05	0.54	0.72	1.27	1.70
90 mm	5000	<0.01	<0.01	0.06	0.01	0.66	0.79	1.55	1.86
95 mm	15 000	<0.01	<0.01	0.26	0.04	0.51	0.75	1.24	1.85
95 mm	10 000	<0.01	<0.01	0.13	0.02	0.58	0.76	1.42	1.89
95 mm	5000	<0.01	<0.01	0.04	<0.01	0.69	0.82	1.67	2.02
Old	15 000	<0.01	<0.01	0.32	0.06	0.47	0.70	1.16	1.75
Old	10 000	<0.01	<0.01	0.16	0.04	0.55	0.71	1.34	1.77
Old	5000	<0.01	<0.01	0.05	0.01	0.66	0.78	1.63	1.94

(c) Fishing Industry Measures

Size Limit	Test Fishing Nights	5yr Catch (t meat)	20yr Catch (t meat)	5yr Catch Variation	20yr Catch Variation	5yr Fishing Nights	20yr Fishing Nights	5yr CPUE (baskets/night)	20yr CPUE (baskets/night)	5yr No. Limit Triggers	20yr No. Limit Triggers
Current	15 000	488	384	0.79	1.10	8051	3846	9	13	2.3	5.4
Current	10 000	526	405	0.70	0.99	7445	4194	10	14	1.6	4.2
Current	5000	394	400	0.61	0.83	5000	3851	12	15	0.9	2.8
90 mm	15 000	488	398	0.79	1.09	8077	3877	9	14	2.4	5.4
90 mm	10 000	541	419	0.70	0.98	7521	4251	10	15	1.6	4.1
90 mm	5000	415	428	0.59	0.81	5081	3992	13	16	0.8	2.6
95 mm	15 000	469	354	0.81	1.12	7776	3602	9	13	2.5	5.6
95 mm	10 000	501	382	0.73	1.02	7227	3764	10	14	1.8	4.5
95 mm	5000	385	377	0.64	0.86	5000	3629	12	15	1.0	3.1
Old	15 000	527	407	0.77	1.07	10 096	4232	9	13	2.2	5.2
Old	10 000	543	443	0.68	0.96	7698	4900	10	13	1.5	3.9
Old	5000	406	433	0.59	0.80	5119	4232	12	15	0.8	2.5

Table 15.1.3.11 Performance of the 70% CPUE reference point and moderate two-way management response measured against different biological and fishing industry objectives. Table (a) outlines the simulation details, Table (b) summaries the overfishing probabilities and expected median population sizes; the shaded cells indicated scenarios where 5-year biomass ratios B_{t+5}/B_{MSY} , are above one, and Table (c) summaries the expected median catch statistics and mean number of triggered catch-rate reference points; the shaded cells highlight the scenarios that result in the best catches, lowest catch variation, highest fishing effort and catch rates, and the lowest number of catch-rate triggers.

(a) Simulation Details

Trawl Sector: Saucer Scallop; **Model:** Monthly Age Structured; **Recruitment Assumption:** Beverton-Holt; **Reference Points:** Limit 70% CPUE; Upper 95 percentile.
Management Response to Triggered Reference Points: For Limit, reduce fishing effort by 10%; For Upper, increase fishing effort by 5%.
Size Limits: 1. Current – Jan to Apr 90 mm and May to Dec 95 mm; 2. 90 mm all year; 3. 95 mm all year; and 4. Old – Nov to Apr 90 mm and May to Aug 95 mm.

(b) Biological Measures

Size Limit	Test Fishing Nights	5yr Probability $B_{t+5} < 20\%K$	20yr Probability $B_{t+20} < 20\%K$	5yr Probability $B_{t+5} < B_{MSY}$	20yr Probability $B_{t+20} < B_{MSY}$	5yr Biomass Ratio B_{t+5}/K	20yr Biomass Ratio B_{t+20}/K	5yr Biomass Ratio B_{t+5}/B_{MSY}	20yr Biomass Ratio B_{t+20}/B_{MSY}
Current	15 000	0.01	<0.01	0.41	0.21	0.44	0.54	1.07	1.34
Current	10 000	<0.01	<0.01	0.19	0.12	0.54	0.61	1.31	1.49
Current	5000	<0.01	<0.01	0.05	0.02	0.67	0.72	1.63	1.76
90 mm	15 000	0.01	0.02	0.52	0.26	0.42	0.53	0.98	1.24
90 mm	10 000	<0.01	<0.01	0.26	0.16	0.52	0.59	1.21	1.39
90 mm	5000	<0.01	<0.01	0.07	0.04	0.65	0.70	1.53	1.64
95 mm	15 000	0.01	<0.01	0.38	0.18	0.45	0.56	1.09	1.39
95 mm	10 000	<0.01	<0.01	0.18	0.11	0.54	0.62	1.33	1.54
95 mm	5000	<0.01	<0.01	0.05	0.02	0.67	0.73	1.66	1.80
Old	15 000	0.01	0.01	0.44	0.24	0.43	0.52	1.05	1.29
Old	10 000	<0.01	<0.01	0.21	0.13	0.52	0.58	1.29	1.44
Old	5000	<0.01	<0.01	0.05	0.03	0.65	0.70	1.61	1.72

(c) Fishing Industry Measures

Size Limit	Test Fishing Nights	5yr Catch (t meat)	20yr Catch (t meat)	5yr Catch Variation	20yr Catch Variation	5yr Fishing Nights	20yr Fishing Nights	5yr CPUE (baskets/night)	20yr CPUE (baskets/night)	5yr No. Limit Triggers	20yr No. Limit Triggers	5yr No. Upper Triggers	20yr No. Upper Triggers
Current	15 000	667	529	0.62	0.99	12916	7175	8	11	2.7	8.5	0.1	0.6
Current	10 000	606	555	0.59	0.95	9546	7178	10	12	1.8	6.1	0.3	1.4
Current	5000	411	477	0.56	0.90	5132	5250	12	14	1.0	3.5	0.5	3.3
90 mm	15 000	662	535	0.63	0.99	12976	7006	8	11	2.8	8.7	0.1	0.6
90 mm	10 000	613	565	0.59	0.94	9639	7196	10	12	1.8	6.1	0.3	1.4
90 mm	5000	428	500	0.55	0.89	5187	5339	13	15	0.9	3.3	0.6	3.5
95 mm	15 000	652	521	0.63	1.00	12583	6626	8	11	2.9	8.8	0.1	0.5
95 mm	10 000	593	531	0.60	0.96	9288	6661	9	12	2.0	6.5	0.2	1.2
95 mm	5000	406	464	0.56	0.92	5055	5038	12	14	1.1	3.8	0.5	3.0
Old	15 000	678	550	0.62	0.98	13 499	7494	8	10	2.5	8.1	0.1	0.7
Old	10 000	616	586	0.58	0.93	9889	7707	9	11	1.6	5.7	0.3	1.6
Old	5000	418	504	0.55	0.88	5222	5411	12	14	0.8	3.1	0.6	3.7

Table 15.1.3.12 Performance of the 70% CPUE reference point and moderate one-way management response measured against different biological and fishing industry objectives. Table (a) outlines the simulation details, Table (b) summaries the overfishing probabilities and expected median population sizes; the shaded cells indicated scenarios where 5-year biomass ratios B_{t+5}/B_{MSY} , are above one, and Table (c) summaries the expected median catch statistics and mean number of triggered catch-rate reference points; the shaded cells highlight the scenarios that result in the best catches, lowest catch variation, highest fishing effort and catch rates, and the lowest number of catch-rate triggers.

(a) Simulation Details

Trawl Sector: Saucer Scallop; **Model:** Monthly Age Structured; **Recruitment Assumption:** Beverton-Holt; **Reference Points:** Limit 70% CPUE; No Upper. **Management Response to Triggered Reference Points:** For Limit, reduce fishing effort by 10%; No Upper, no increase in fishing effort. **Size Limits:** 1. Current – Jan to Apr 90 mm and May to Dec 95 mm; 2. 90 mm all year; 3. 95 mm all year; and 4. Old – Nov to Apr 90 mm and May to Aug 95 mm.

(b) Biological Measures

Size Limit	Test Fishing Nights	5yr Probability $B_{t+5}<20\%K$	20yr Probability $B_{t+20}<20\%K$	5yr Probability $B_{t+5}<B_{MSY}$	20yr Probability $B_{t+20}<B_{MSY}$	5yr Biomass Ratio B_{t+5}/K	20yr Biomass Ratio B_{t+20}/K	5yr Biomass Ratio B_{t+5}/B_{MSY}	20yr Biomass Ratio B_{t+20}/B_{MSY}
Current	15 000	0.01	<0.01	0.41	0.2	0.44	0.55	1.07	1.35
Current	10 000	<0.01	<0.01	0.19	0.1	0.54	0.62	1.31	1.52
Current	5000	<0.01	<0.01	0.05	0.02	0.67	0.75	1.63	1.83
90 mm	15 000	0.01	0.02	0.52	0.25	0.42	0.53	0.98	1.25
90 mm	10 000	<0.01	<0.01	0.26	0.13	0.52	0.60	1.21	1.41
90 mm	5000	<0.01	<0.01	0.07	0.03	0.65	0.73	1.54	1.73
95 mm	15 000	0.01	<0.01	0.38	0.18	0.45	0.57	1.09	1.39
95 mm	10 000	<0.01	<0.01	0.18	0.09	0.54	0.64	1.33	1.57
95 mm	5000	<0.01	<0.01	0.05	0.01	0.67	0.76	1.66	1.87
Old	15 000	0.01	0.01	0.44	0.22	0.43	0.53	1.05	1.30
Old	10 000	<0.01	<0.01	0.21	0.11	0.52	0.61	1.29	1.48
Old	5000	<0.01	<0.01	0.05	0.02	0.65	0.73	1.61	1.82

(c) Fishing Industry Measures

Size Limit	Test Fishing Nights	5yr Catch (t meat)	20yr Catch (t meat)	5yr Catch Variation	20yr Catch Variation	5yr Fishing Nights	20yr Fishing Nights	5yr CPUE (baskets/night)	20yr CPUE (baskets/night)	5yr No. Limit Triggers	20yr No. Limit Triggers
Current	15 000	667	529	0.61	0.91	12916	7175	8	11	2.7	8.4
Current	10 000	605	554	0.57	0.82	9541	7101	10	12	1.8	6.1
Current	5000	411	458	0.53	0.70	5054	5000	12	14	1.0	3.4
90 mm	15 000	662	535	0.61	0.92	12976	6983	8	11	2.8	8.7
90 mm	10 000	613	565	0.57	0.83	9634	7056	10	12	1.8	6.1
90 mm	5000	428	482	0.52	0.69	5108	5000	13	15	0.9	3.3
95 mm	15 000	652	521	0.61	0.92	12583	6585	8	11	2.9	8.8
95 mm	10 000	593	531	0.58	0.84	9278	6566	9	12	2.0	6.5
95 mm	5000	406	449	0.53	0.72	5000	4794	12	14	1.1	3.8
Old	15 000	678	550	0.61	0.90	13 499	7446	8	10	2.5	8.1
Old	10 000	616	580	0.56	0.81	9854	7548	9	12	1.6	5.7
Old	5000	418	477	0.52	0.68	5140	5000	12	14	0.8	3.1

Table 15.1.3.13 Performance of the 70% CPUE reference point and heavy two-way management response measured against different biological and fishing industry objectives. Table (a) outlines the simulation details, Table (b) summaries the overfishing probabilities and expected median population sizes; the shaded cells indicated scenarios where 5-year biomass ratios B_{t+5}/B_{MSY} , are above one, and Table (c) summaries the expected median catch statistics and mean number of triggered catch-rate reference points; the shaded cells highlight the scenarios that result in the best catches, lowest catch variation, highest fishing effort and catch rates, and the lowest number of catch-rate triggers.

(a) Simulation Details

Trawl Sector: Saucer Scallop; **Model:** Monthly Age Structured; **Recruitment Assumption:** Ricker; **Reference Points:** Limit 70% CPUE; Upper 95 percentile.
Management Response to Triggered Reference Points: For Limit, reduce fishing effort by 30%; For Upper, increase fishing effort by 15%.
Size Limits: 1. Current – Jan to Apr 90 mm and May to Dec 95 mm; 2. 90 mm all year; 3. 95 mm all year; and 4. Old – Nov to Apr 90 mm and May to Aug 95 mm.

(b) Biological Measures

Size Limit	Test Fishing Nights	5yr Probability $B_{t+5} < 20\%K$	20yr Probability $B_{t+20} < 20\%K$	5yr Probability $B_{t+5} < B_{MSY}$	20yr Probability $B_{t+20} < B_{MSY}$	5yr Biomass Ratio B_{t+5}/K	20yr Biomass Ratio B_{t+20}/K	5yr Biomass Ratio B_{t+5}/B_{MSY}	20yr Biomass Ratio B_{t+20}/B_{MSY}
Current	15 000	<0.01	<0.01	0.45	0.14	0.48	0.71	1.05	1.55
Current	10 000	<0.01	<0.01	0.3	0.16	0.55	0.69	1.21	1.50
Current	5000	<0.01	<0.01	0.12	0.13	0.66	0.72	1.45	1.59
90 mm	15 000	<0.01	<0.01	0.54	0.16	0.46	0.69	0.98	1.48
90 mm	10 000	<0.01	<0.01	0.38	0.2	0.53	0.68	1.13	1.44
90 mm	5000	<0.01	<0.01	0.15	0.17	0.65	0.70	1.37	1.47
95 mm	15 000	<0.01	<0.01	0.42	0.12	0.50	0.73	1.09	1.62
95 mm	10 000	<0.01	<0.01	0.28	0.13	0.57	0.72	1.24	1.59
95 mm	5000	<0.01	<0.01	0.11	0.11	0.67	0.75	1.48	1.64
Old	15 000	<0.01	<0.01	0.48	0.17	0.46	0.68	1.02	1.50
Old	10 000	<0.01	<0.01	0.32	0.19	0.53	0.66	1.18	1.45
Old	5000	<0.01	<0.01	0.12	0.16	0.65	0.69	1.43	1.53

(c) Fishing Industry Measures

Size Limit	Test Fishing Nights	5yr Catch (t meat)	20yr Catch (t meat)	5yr Catch Variation	20yr Catch Variation	5yr Fishing Nights	20yr Fishing Nights	5yr CPUE (baskets/night)	20yr CPUE (baskets/night)	5yr No. Limit Triggers	20yr No. Limit Triggers	5yr No. Upper Triggers	20yr No. Upper Triggers
Current	15 000	483	353	0.76	1.15	7999	3793	8	13	2.5	5.8	0.1	1.0
Current	10 000	518	404	0.71	1.10	7373	4536	10	12	1.7	4.6	0.2	1.3
Current	5000	389	427	0.66	1.09	5003	5000	12	13	1.0	3.0	0.4	2.7
90 mm	15 000	479	360	0.76	1.12	7977	3764	9	14	2.5	5.8	0.1	1.0
90 mm	10 000	522	414	0.71	1.07	7472	4376	10	13	1.7	4.5	0.2	1.3
90 mm	5000	404	453	0.65	1.04	5099	5188	13	14	0.9	2.9	0.5	2.7
95 mm	15 000	442	321	0.78	1.18	7672	3461	9	13	2.6	6.0	0.1	1.0
95 mm	10 000	491	385	0.74	1.14	7228	3945	10	13	1.8	4.8	0.1	1.2
95 mm	5000	383	406	0.68	1.14	5000	4321	12	13	1.1	3.3	0.4	2.5
Old	15 000	518	368	0.75	1.12	8586	3989	8	12	2.3	5.6	0.1	1.0
Old	10 000	547	421	0.69	1.06	7643	4941	10	12	1.5	4.3	0.2	1.4
Old	5000	399	458	0.64	1.05	5128	5338	12	13	0.8	2.8	0.5	2.9

Table 15.1.3.14 Performance of the 70% CPUE reference point and heavy one-way management response measured against different biological and fishing industry objectives. Table (a) outlines the simulation details, Table (b) summaries the overfishing probabilities and expected median population sizes; the shaded cells indicated scenarios where 5-year biomass ratios B_{t+5}/B_{MSY} , are above one, and Table (c) summaries the expected median catch statistics and mean number of triggered catch-rate reference points; the shaded cells highlight the scenarios that result in the best catches, lowest catch variation, highest fishing effort and catch rates, and the lowest number of catch-rate triggers.

(a) Simulation Details

Trawl Sector: Saucer Scallop; **Model:** Monthly Age Structured; **Recruitment Assumption:** Ricker; **Reference Points:** Limit 70% CPUE; No Upper.
Management Response to Triggered Reference Points: For Limit, reduce fishing effort by 30%; No Upper, no increase in fishing effort.
Size Limits: 1. Current – Jan to Apr 90 mm and May to Dec 95 mm; 2. 90 mm all year; 3. 95 mm all year; and 4. Old – Nov to Apr 90 mm and May to Aug 95 mm.

(b) Biological Measures

Size Limit	Test Fishing Nights	5yr Probability $B_{t+5} < 20\%K$	20yr Probability $B_{t+20} < 20\%K$	5yr Probability $B_{t+5} < B_{MSY}$	20yr Probability $B_{t+20} < B_{MSY}$	5yr Biomass Ratio B_{t+5}/K	20yr Biomass Ratio B_{t+20}/K	5yr Biomass Ratio B_{t+5}/B_{MSY}	20yr Biomass Ratio B_{t+20}/B_{MSY}
Current	15 000	<0.01	<0.01	0.45	0.1	0.48	0.74	1.05	1.62
Current	10 000	<0.01	<0.01	0.3	0.09	0.55	0.73	1.21	1.61
Current	5000	<0.01	<0.01	0.12	0.02	0.66	0.81	1.45	1.78
90 mm	15 000	<0.01	<0.01	0.54	0.11	0.46	0.73	0.98	1.54
90 mm	10 000	<0.01	<0.01	0.37	0.11	0.53	0.72	1.13	1.53
90 mm	5000	<0.01	<0.01	0.15	0.03	0.65	0.80	1.37	1.68
95 mm	15 000	<0.01	<0.01	0.42	0.08	0.50	0.76	1.09	1.67
95 mm	10 000	<0.01	<0.01	0.28	0.08	0.57	0.75	1.24	1.68
95 mm	5000	<0.01	<0.01	0.1	0.02	0.67	0.83	1.48	1.80
Old	15 000	<0.01	<0.01	0.48	0.12	0.46	0.70	1.02	1.57
Old	10 000	<0.01	<0.01	0.32	0.1	0.53	0.71	1.18	1.57
Old	5000	<0.01	<0.01	0.12	0.03	0.65	0.79	1.43	1.75

(c) Fishing Industry Measures

Size Limit	Test Fishing Nights	5yr Catch (t meat)	20yr Catch (t meat)	5yr Catch Variation	20yr Catch Variation	5yr Fishing Nights	20yr Fishing Nights	5yr CPUE (baskets/night)	20yr CPUE (baskets/night)	5yr No. Limit Triggers	20yr No. Limit Triggers
Current	15 000	483	328	0.74	1.13	7999	3602	8	13	2.5	5.8
Current	10 000	518	382	0.67	1.03	7369	3937	10	13	1.7	4.5
Current	5000	389	381	0.59	0.85	5000	3787	12	15	1.0	3.0
90 mm	15 000	479	325	0.75	1.12	7977	3602	9	14	2.5	5.8
90 mm	10 000	522	391	0.67	1.02	7459	3883	10	14	1.7	4.5
90 mm	5000	404	415	0.57	0.83	5041	3885	13	16	0.9	2.9
95 mm	15 000	442	304	0.77	1.16	7672	2931	9	13	2.6	6.0
95 mm	10 000	491	352	0.70	1.06	7219	3638	10	13	1.8	4.8
95 mm	5000	382	364	0.61	0.89	5000	3577	12	14	1.1	3.3
Old	15 000	518	340	0.72	1.11	8586	3602	8	13	2.3	5.6
Old	10 000	547	399	0.65	0.99	7636	4458	10	13	1.5	4.2
Old	5000	399	409	0.56	0.82	5090	4048	12	15	0.8	2.8

Table 15.1.3.15 Performance of the 70% CPUE reference point and moderate two-way management response measured against different biological and fishing industry objectives. Table (a) outlines the simulation details, Table (b) summaries the overfishing probabilities and expected median population sizes; the shaded cells indicated scenarios where 5-year biomass ratios B_{t+5}/B_{MSY} , are above one, and Table (c) summaries the expected median catch statistics and mean number of triggered catch-rate reference points; the shaded cells highlight the scenarios that result in the best catches, lowest catch variation, highest fishing effort and catch rates, and the lowest number of catch-rate triggers.

(a) Simulation Details

Trawl Sector: Saucer Scallop; **Model:** Monthly Age Structured; **Recruitment Assumption:** Ricker; **Reference Points:** Limit 70% CPUE; Upper 95 percentile.
Management Response to Triggered Reference Points: For Limit, reduce fishing effort by 10%; For Upper, increase fishing effort by 5%.
Size Limits: 1. Current – Jan to Apr 90 mm and May to Dec 95 mm; 2. 90 mm all year; 3. 95 mm all year; and 4. Old – Nov to Apr 90 mm and May to Aug 95 mm.

(b) Biological Measures

Size Limit	Test Fishing Nights	5yr Probability $B_{t+5} < 20\%K$	20yr Probability $B_{t+20} < 20\%K$	5yr Probability $B_{t+5} < B_{MSY}$	20yr Probability $B_{t+20} < B_{MSY}$	5yr Biomass Ratio B_{t+5}/K	20yr Biomass Ratio B_{t+20}/K	5yr Biomass Ratio B_{t+5}/B_{MSY}	20yr Biomass Ratio B_{t+20}/B_{MSY}
Current	15 000	0.01	<0.01	0.57	0.35	0.43	0.53	0.94	1.17
Current	10 000	<0.01	<0.01	0.36	0.22	0.53	0.60	1.14	1.31
Current	5000	<0.01	<0.01	0.13	0.06	0.65	0.72	1.43	1.59
90 mm	15 000	0.02	0.02	0.66	0.42	0.41	0.51	0.87	1.09
90 mm	10 000	<0.01	<0.01	0.42	0.28	0.50	0.57	1.07	1.22
90 mm	5000	<0.01	<0.01	0.17	0.09	0.64	0.70	1.36	1.51
95 mm	15 000	0.01	<0.01	0.54	0.31	0.44	0.55	0.96	1.21
95 mm	10 000	<0.01	<0.01	0.34	0.19	0.53	0.61	1.17	1.36
95 mm	5000	<0.01	<0.01	0.12	0.05	0.66	0.73	1.45	1.62
Old	15 000	0.02	0.01	0.59	0.39	0.41	0.50	0.92	1.12
Old	10 000	<0.01	<0.01	0.37	0.25	0.51	0.57	1.13	1.26
Old	5000	<0.01	<0.01	0.14	0.07	0.64	0.70	1.42	1.57

(c) Fishing Industry Measures

Size Limit	Test Fishing Nights	5yr Catch (t meat)	20yr Catch (t meat)	5yr Catch Variation	20yr Catch Variation	5yr Fishing Nights	20yr Fishing Nights	5yr CPUE (baskets/night)	20yr CPUE (baskets/night)	5yr No. Limit Triggers	20yr No. Limit Triggers	5yr No. Upper Triggers	20yr No. Upper Triggers
Current	15 000	650	447	0.57	0.97	12 816	6173	8	10	2.8	9.1	0.1	0.5
Current	10 000	604	493	0.55	0.95	9457	6561	9	11	1.9	6.5	0.2	1.2
Current	5000	409	455	0.52	0.92	5101	5171	12	13	1.0	3.6	0.4	3.2
90 mm	15 000	643	434	0.57	0.97	12 863	5811	8	11	2.9	9.4	0.0	0.4
90 mm	10 000	613	493	0.55	0.94	9523	6519	10	12	1.9	6.6	0.1	1.2
90 mm	5000	425	475	0.52	0.90	5130	5251	12	14	1.0	3.5	0.5	3.3
95 mm	15 000	634	439	0.57	0.98	12 403	5898	8	10	3.0	9.4	0.0	0.4
95 mm	10 000	585	470	0.55	0.96	9246	6253	9	11	2.1	6.8	0.1	1.1
95 mm	5000	405	447	0.53	0.93	5010	5000	12	13	1.2	4.0	0.4	2.9
Old	15 000	661	454	0.56	0.96	13 453	6457	8	10	2.7	8.9	0.1	0.5
Old	10 000	611	506	0.54	0.94	9808	6965	9	11	1.7	6.1	0.2	1.4
Old	5000	417	469	0.51	0.90	5160	5381	12	13	0.9	3.3	0.5	3.6

Table 15.1.3.16 Performance of the 70% CPUE reference point and moderate one-way management response measured against different biological and fishing industry objectives. Table (a) outlines the simulation details, Table (b) summaries the overfishing probabilities and expected median population sizes; the shaded cells indicated scenarios where 5-year biomass ratios B_{t+5}/B_{MSY} , are above one, and Table (c) summaries the expected median catch statistics and mean number of triggered catch-rate reference points; the shaded cells highlight the scenarios that result in the best catches, lowest catch variation, highest fishing effort and catch rates, and the lowest number of catch-rate triggers.

(a) Simulation Details

Trawl Sector: Saucer Scallop; **Model:** Monthly Age Structured; **Recruitment Assumption:** Ricker; **Reference Points:** Limit 70% CPUE; No Upper.
Management Response to Triggered Reference Points: For Limit, reduce fishing effort by 10%; No Upper, no increase in fishing effort.
Size Limits: 1. Current – Jan to Apr 90 mm and May to Dec 95 mm; 2. 90 mm all year; 3. 95 mm all year; and 4. Old – Nov to Apr 90 mm and May to Aug 95 mm.

(b) Biological Measures

Size Limit	Test Fishing Nights	5yr Probability $B_{t+5} < 20\%K$	20yr Probability $B_{t+20} < 20\%K$	5yr Probability $B_{t+5} < B_{MSY}$	20yr Probability $B_{t+20} < B_{MSY}$	5yr Biomass Ratio B_{t+5}/K	20yr Biomass Ratio B_{t+20}/K	5yr Biomass Ratio B_{t+5}/B_{MSY}	20yr Biomass Ratio B_{t+20}/B_{MSY}
Current	15 000	0.01	<0.01	0.57	0.34	0.43	0.54	0.94	1.19
Current	10 000	<0.01	<0.01	0.35	0.18	0.53	0.62	1.15	1.35
Current	5000	<0.01	<0.01	0.13	0.04	0.65	0.75	1.44	1.66
90 mm	15 000	0.02	0.01	0.66	0.4	0.41	0.52	0.87	1.10
90 mm	10 000	<0.01	<0.01	0.42	0.24	0.50	0.59	1.07	1.26
90 mm	5000	<0.01	<0.01	0.17	0.06	0.64	0.74	1.36	1.58
95 mm	15 000	0.01	<0.01	0.54	0.29	0.44	0.56	0.96	1.22
95 mm	10 000	<0.01	<0.01	0.34	0.16	0.53	0.63	1.17	1.39
95 mm	5000	<0.01	<0.01	0.12	0.04	0.66	0.77	1.46	1.68
Old	15 000	0.02	0.01	0.59	0.38	0.42	0.51	0.92	1.12
Old	10 000	<0.01	<0.01	0.37	0.21	0.51	0.60	1.13	1.30
Old	5000	<0.01	<0.01	0.14	0.05	0.64	0.74	1.42	1.65

(c) Fishing Industry Measures

Size Limit	Test Fishing Nights	5yr Catch (t meat)	20yr Catch (t meat)	5yr Catch Variation	20yr Catch Variation	5yr Fishing Nights	20yr Fishing Nights	5yr CPUE (baskets/night)	20yr CPUE (baskets/night)	5yr No. Limit Triggers	20yr No. Limit Triggers
Current	15 000	650	447	0.56	0.94	12 816	6173	8	10	2.8	9.1
Current	10 000	604	493	0.53	0.86	9455	6561	9	11	1.9	6.4
Current	5000	407	440	0.50	0.73	5048	4862	12	14	1.0	3.6
90 mm	15 000	643	434	0.57	0.95	12 863	5811	8	11	2.9	9.4
90 mm	10 000	613	487	0.53	0.86	9513	6433	10	12	1.9	6.5
90 mm	5000	425	458	0.49	0.72	5094	4970	12	15	1.0	3.5
95 mm	15 000	634	439	0.56	0.95	12 403	5895	8	10	3.0	9.4
95 mm	10 000	585	468	0.54	0.87	9246	6200	9	11	2.1	6.8
95 mm	5000	404	435	0.51	0.74	5000	4636	12	14	1.2	4.0
Old	15 000	661	454	0.56	0.93	13 453	6457	8	10	2.7	8.8
Old	10 000	611	504	0.53	0.85	9803	6867	9	11	1.7	6.1
Old	5000	416	458	0.49	0.71	5116	5000	12	14	0.9	3.3

Table 15.1.3.17 Performance of the 60% CPUE reference point and heavy two-way management response measured against different biological and fishing industry objectives. Table (a) outlines the simulation details, Table (b) summaries the overfishing probabilities and expected median population sizes; the shaded cells indicated scenarios where 5-year biomass ratios B_{t+5}/B_{MSY} , are above one, and Table (c) summaries the expected median catch statistics and mean number of triggered catch-rate reference points; the shaded cells highlight the scenarios that result in the best catches, lowest catch variation, highest fishing effort and catch rates, and the lowest number of catch-rate triggers.

(a) Simulation Details

Trawl Sector: Saucer Scallop; **Model:** Monthly Age Structured; **Recruitment Assumption:** Beverton-Holt; **Reference Points:** Limit 60% CPUE; Upper 95 percentile.
Management Response to Triggered Reference Points: For Limit, reduce fishing effort by 30%; For Upper, increase fishing effort by 15%.
Size Limits: 1. Current – Jan to Apr 90 mm and May to Dec 95 mm; 2. 90 mm all year; 3. 95 mm all year; and 4. Old – Nov to Apr 90 mm and May to Aug 95 mm.

(b) Biological Measures

Size Limit	Test Fishing Nights	5yr Probability $B_{t+5} < 20\%K$	20yr Probability $B_{t+20} < 20\%K$	5yr Probability $B_{t+5} < B_{MSY}$	20yr Probability $B_{t+20} < B_{MSY}$	5yr Biomass Ratio B_{t+5}/K	20yr Biomass Ratio B_{t+20}/K	5yr Biomass Ratio B_{t+5}/B_{MSY}	20yr Biomass Ratio B_{t+20}/B_{MSY}
Current	15 000	<0.01	<0.01	0.38	0.12	0.46	0.63	1.11	1.55
Current	10 000	<0.01	<0.01	0.19	0.12	0.53	0.63	1.31	1.55
Current	5000	<0.01	<0.01	0.05	0.07	0.66	0.68	1.62	1.66
90 mm	15 000	<0.01	<0.01	0.48	0.15	0.44	0.61	1.02	1.46
90 mm	10 000	<0.01	<0.01	0.26	0.16	0.52	0.61	1.21	1.46
90 mm	5000	<0.01	<0.01	0.07	0.09	0.65	0.66	1.52	1.56
95 mm	15 000	<0.01	<0.01	0.34	0.09	0.47	0.66	1.15	1.61
95 mm	10 000	<0.01	<0.01	0.18	0.1	0.55	0.65	1.33	1.60
95 mm	5000	<0.01	<0.01	0.05	0.06	0.67	0.70	1.64	1.72
Old	15 000	0.01	<0.01	0.41	0.15	0.44	0.60	1.07	1.49
Old	10 000	<0.01	<0.01	0.21	0.14	0.52	0.59	1.28	1.50
Old	5000	<0.01	<0.01	0.05	0.08	0.65	0.66	1.61	1.62

(c) Fishing Industry Measures

Size Limit	Test Fishing Nights	5yr Catch (t meat)	20yr Catch (t meat)	5yr Catch Variation	20yr Catch Variation	5yr Fishing Nights	20yr Fishing Nights	5yr CPUE (baskets/night)	20yr CPUE (baskets/night)	5yr No. Limit Triggers	20yr No. Limit Triggers	5yr No. Upper Triggers	20yr No. Upper Triggers
Current	15 000	628	487	0.75	1.10	11 325	5841	8	12	1.8	4.6		0.6
Current	10 000	623	533	0.68	1.05	10 204	7000	9	12	1.1	3.3	0.2	1.0
Current	5000	419	509	0.64	1.06	5292	5750	12		0.5	1.9	0.5	2.5
90 mm	15 000	624	492	0.76	1.09	11 257	5726	8	12	1.8	4.7		0.6
90 mm	10 000	629	532	0.68	1.04	10 227	6831	10	12	1.1	3.4	0.2	1.0
90 mm	5000	436	530	0.63		5315	5813			0.4	1.8	0.6	2.6
95 mm	15 000	595	451	0.77	1.13	10 960	5483	8	12	2.0	4.8		
95 mm	10 000	608	503	0.70	1.08	10 000	6096	9	12	1.2	3.6	0.2	0.9
95 mm	5000	418	492	0.65	1.10	5263	5514	12		0.6	2.2	0.5	2.3
Old	15 000		501	0.73	1.08		6354	8	11	1.6	4.4		0.6
Old	10 000	633		0.67	1.03	10 328		9	11	0.9	3.1	0.3	1.2
Old	5000	424	538		1.03	5332	6024	12	12			0.6	2.8

Table 15.1.3.18 Performance of the 60% CPUE reference point and heavy one-way management response measured against different biological and fishing industry objectives. Table (a) outlines the simulation details, Table (b) summaries the overfishing probabilities and expected median population sizes; the shaded cells indicated scenarios where 5-year biomass ratios B_{t+5}/B_{MSY} , are above one, and Table (c) summaries the expected median catch statistics and mean number of triggered catch-rate reference points; the shaded cells highlight the scenarios that result in the best catches, lowest catch variation, highest fishing effort and catch rates, and the lowest number of catch-rate triggers.

(a) Simulation Details

Trawl Sector: Saucer Scallop; **Model:** Monthly Age Structured; **Recruitment Assumption:** Beverton-Holt; **Reference Points:** Limit 60% CPUE; No Upper. **Management Response to Triggered Reference Points:** For Limit, reduce fishing effort by 30%; No Upper, no increase in fishing effort. **Size Limits:** 1. Current – Jan to Apr 90 mm and May to Dec 95 mm; 2. 90 mm all year; 3. 95 mm all year; and 4. Old – Nov to Apr 90 mm and May to Aug 95 mm.

(b) Biological Measures

Size Limit	Test Fishing Nights	5yr Probability $B_{t+5} < 20\%K$	20yr Probability $B_{t+20} < 20\%K$	5yr Probability $B_{t+5} < B_{MSY}$	20yr Probability $B_{t+20} < B_{MSY}$	5yr Biomass Ratio B_{t+5}/K	20yr Biomass Ratio B_{t+20}/K	5yr Biomass Ratio B_{t+5}/B_{MSY}	20yr Biomass Ratio B_{t+20}/B_{MSY}
Current	15 000	<0.01	<0.01	0.38	0.09	0.46	0.65	1.11	1.61
Current	10 000	<0.01	<0.01	0.19	0.07	0.54	0.67	1.31	1.65
Current	5000	<0.01	<0.01	0.05	0.02	0.66	0.76	1.62	1.87
90 mm	15 000	<0.01	<0.01	0.48	0.12	0.44	0.63	1.02	1.52
90 mm	10 000	<0.01	<0.01	0.26	0.09	0.52	0.65	1.22	1.57
90 mm	5000	<0.01	<0.01	0.07	0.02	0.65	0.74	1.53	1.76
95 mm	15 000	<0.01	<0.01	0.34	0.07	0.47	0.67	1.15	1.67
95 mm	10 000	<0.01	<0.01	0.18	0.06	0.55	0.69	1.33	1.71
95 mm	5000	<0.01	<0.01	0.05	0.01	0.67	0.77	1.65	1.90
Old	15 000	0.01	<0.01	0.41	0.12	0.44	0.62	1.08	1.56
Old	10 000	<0.01	<0.01	0.21	0.08	0.52	0.65	1.29	1.60
Old	5000	<0.01	<0.01	0.05	0.02	0.65	0.74	1.61	1.85

(c) Fishing Industry Measures

Size Limit	Test Fishing Nights	5yr Catch (t meat)	20yr Catch (t meat)	5yr Catch Variation	20yr Catch Variation	5yr Fishing Nights	20yr Fishing Nights	5yr CPUE (baskets/night)	20yr CPUE (baskets/night)	5yr No. Limit Triggers	20yr No. Limit Triggers
Current	15 000	628	460	0.71	1.02	11 316	5513	8	12	1.8	4.6
Current	10 000	621	527	0.62	0.90	10 135	7000	9	12	1.1	3.3
Current	5000	419	467	0.54	0.74	5229	5000	12	14	0.5	1.9
90 mm	15 000	624	465	0.72	1.03	11 248	5233	8	13	1.8	4.6
90 mm	10 000	628	527	0.62	0.90	10 175	6238	10	13	1.1	3.3
90 mm	5000	435	490	0.52	0.73	5243	5000	13	15	0.4	1.8
95 mm	15 000	595	440	0.74	1.05	10 960	5145	8	12	2.0	4.8
95 mm	10 000	606	500	0.64	0.93	10 000	5895	9	12	1.2	3.6
95 mm	5000	418	455	0.56	0.76	5203	5000	12	14	0.6	2.2
Old	15 000	666	485	0.69	1.01	11 777	5952	8	12	1.6	4.4
Old	10 000	633	546	0.60	0.88	10 266	7284	9	12	0.9	3.1
Old	5000	423	482	0.52	0.71	5252	5040	12	14	0.4	1.7

Table 15.1.3.19 Performance of the 60% CPUE reference point and moderate two-way management response measured against different biological and fishing industry objectives. Table (a) outlines the simulation details, Table (b) summaries the overfishing probabilities and expected median population sizes; the shaded cells indicated scenarios where 5-year biomass ratios B_{t+5}/B_{MSY} , are above one, and Table (c) summaries the expected median catch statistics and mean number of triggered catch-rate reference points; the shaded cells highlight the scenarios that result in the best catches, lowest catch variation, highest fishing effort and catch rates, and the lowest number of catch-rate triggers.

(a) Simulation Details

Trawl Sector: Saucer Scallop; **Model:** Monthly Age Structured; **Recruitment Assumption:** Beverton-Holt; **Reference Points:** Limit 60% CPUE; Upper 95 percentile.
Management Response to Triggered Reference Points: For Limit, reduce fishing effort by 10%; For Upper, increase fishing effort by 5%.
Size Limits: 1. Current – Jan to Apr 90 mm and May to Dec 95 mm; 2. 90 mm all year; 3. 95 mm all year; and 4. Old – Nov to Apr 90 mm and May to Aug 95 mm.

(b) Biological Measures

Size Limit	Test Fishing Nights	5yr Probability $B_{t+5} < 20\%K$	20yr Probability $B_{t+20} < 20\%K$	5yr Probability $B_{t+5} < B_{MSY}$	20yr Probability $B_{t+20} < B_{MSY}$	5yr Biomass Ratio B_{t+5}/K	20yr Biomass Ratio B_{t+20}/K	5yr Biomass Ratio B_{t+5}/B_{MSY}	20yr Biomass Ratio B_{t+20}/B_{MSY}
Current	15 000	0.01	0.02	0.46	0.29	0.43	0.50	1.04	1.23
Current	10 000	<0.01	<0.01	0.21	0.17	0.52	0.57	1.29	1.38
Current	5000	<0.01	<0.01	0.05	0.03	0.66	0.70	1.62	1.70
90 mm	15 000	0.01	0.02	0.56	0.36	0.41	0.48	0.96	1.13
90 mm	10 000	<0.01	<0.01	0.29	0.23	0.51	0.54	1.19	1.28
90 mm	5000	<0.01	<0.01	0.07	0.05	0.65	0.68	1.52	1.60
95 mm	15 000	0.01	0.01	0.42	0.25	0.44	0.52	1.06	1.27
95 mm	10 000	<0.01	<0.01	0.2	0.15	0.53	0.58	1.31	1.43
95 mm	5000	<0.01	<0.01	0.05	0.03	0.67	0.71	1.64	1.74
Old	15 000	0.01	0.02	0.48	0.33	0.42	0.48	1.01	1.18
Old	10 000	<0.01	<0.01	0.23	0.19	0.51	0.54	1.26	1.34
Old	5000	<0.01	<0.01	0.05	0.04	0.65	0.68	1.61	1.68

(c) Fishing Industry Measures

Size Limit	Test Fishing Nights	5yr Catch (t meat)	20yr Catch (t meat)	5yr Catch Variation	20yr Catch Variation	5yr Fishing Nights	20yr Fishing Nights	5yr CPUE (baskets/night)	20yr CPUE (baskets/night)	5yr No. Limit Triggers	20yr No. Limit Triggers	5yr No. Upper Triggers	20yr No. Upper Triggers
Current	15 000	705	578	0.61	0.95	14 502	8959	7	10	2.0	7.2	0.1	0.5
Current	10 000	634	608	0.57	0.90	10 267	9000	9	11	1.2	4.8	0.2	1.3
Current	5000	422	506	0.53	0.86	5281	5585	12	13	0.5	2.4	0.5	3.3
90 mm	15 000	701	577	0.61	0.96	14 418	8775	8	10	2.1	7.4	0.1	0.5
90 mm	10 000	649	615	0.57	0.90	10 288	8996	10	11	1.2	4.9	0.3	1.3
90 mm	5000	438	525	0.53	0.85	5300	5626	13	14	0.5	2.3	0.6	3.4
95 mm	15 000	701	577	0.61	0.95	13 981	8425	7	10	2.2	7.5	0.1	0.5
95 mm	10 000	632	601	0.57	0.91	10 186	8443	9	11	1.3	5.1	0.2	1.1
95 mm	5000	419	494	0.54	0.87	5252	5452	12	13	0.6	2.7	0.5	2.9
Old	15 000	714	589	0.60	0.95	15 000	9422	7	9	1.8	6.9	0.1	0.6
Old	10 000	641	629	0.56	0.89	10 374	9306	9	11	1.0	4.5	0.3	1.5
Old	5000	427	519	0.53	0.85	5312	5782	12	13	0.4	2.1	0.6	3.6

Table 15.1.3.20 Performance of the 60% CPUE reference point and moderate one-way management response measured against different biological and fishing industry objectives. Table (a) outlines the simulation details, Table (b) summaries the overfishing probabilities and expected median population sizes; the shaded cells indicated scenarios where 5-year biomass ratios B_{t+5}/B_{MSY} , are above one, and Table (c) summaries the expected median catch statistics and mean number of triggered catch-rate reference points; the shaded cells highlight the scenarios that result in the best catches, lowest catch variation, highest fishing effort and catch rates, and the lowest number of catch-rate triggers.

(a) Simulation Details

Trawl Sector: Saucer Scallop; **Model:** Monthly Age Structured; **Recruitment Assumption:** Beverton-Holt; **Reference Points:** Limit 60% CPUE; No Upper.
Management Response to Triggered Reference Points: For Limit, reduce fishing effort by 10%; No Upper, no increase in fishing effort.
Size Limits: 1. Current – Jan to Apr 90 mm and May to Dec 95 mm; 2. 90 mm all year; 3. 95 mm all year; and 4. Old – Nov to Apr 90 mm and May to Aug 95 mm.

(b) Biological Measures

Size Limit	Test Fishing Nights	5yr Probability $B_{t+5} < 20\%K$	20yr Probability $B_{t+20} < 20\%K$	5yr Probability $B_{t+5} < B_{MSY}$	20yr Probability $B_{t+20} < B_{MSY}$	5yr Biomass Ratio B_{t+5}/K	20yr Biomass Ratio B_{t+20}/K	5yr Biomass Ratio B_{t+5}/B_{MSY}	20yr Biomass Ratio B_{t+20}/B_{MSY}
Current	15 000	0.01	0.02	0.46	0.28	0.43	0.51	1.04	1.24
Current	10 000	<0.01	<0.01	0.21	0.15	0.52	0.58	1.29	1.42
Current	5000	<0.01	<0.01	0.05	0.03	0.66	0.73	1.62	1.78
90 mm	15 000	0.01	0.02	0.56	0.35	0.41	0.49	0.96	1.14
90 mm	10 000	<0.01	<0.01	0.28	0.2	0.51	0.56	1.19	1.31
90 mm	5000	<0.01	<0.01	0.07	0.04	0.65	0.71	1.52	1.67
95 mm	15 000	0.01	0.01	0.42	0.25	0.44	0.52	1.06	1.28
95 mm	10 000	<0.01	<0.01	0.2	0.13	0.53	0.59	1.31	1.46
95 mm	5000	<0.01	<0.01	0.05	0.02	0.67	0.73	1.64	1.80
Old	15 000	0.01	0.02	0.48	0.31	0.42	0.48	1.01	1.19
Old	10 000	<0.01	<0.01	0.23	0.17	0.51	0.56	1.26	1.38
Old	5000	<0.01	<0.01	0.05	0.03	0.65	0.71	1.61	1.76

(c) Fishing Industry Measures

Size Limit	Test Fishing Nights	5yr Catch (t meat)	20yr Catch (t meat)	5yr Catch Variation	20yr Catch Variation	5yr Fishing Nights	20yr Fishing Nights	5yr CPUE (baskets/night)	20yr CPUE (baskets/night)	5yr No. Limit Triggers	20yr No. Limit Triggers
Current	15 000	705	578	0.59	0.88	14 502	8927	7	10	2.0	7.2
Current	10 000	634	607	0.55	0.78	10 212	9000	9	11	1.2	4.8
Current	5000	422	484	0.50	0.66	5237	5052	12	14	0.5	2.4
90 mm	15 000	701	577	0.60	0.89	14 418	8775	8	10	2.1	7.4
90 mm	10 000	649	613	0.54	0.79	10 230	8974	10	11	1.2	4.9
90 mm	5000	438	502	0.50	0.65	5250	5070	13	15	0.5	2.3
95 mm	15 000	701	577	0.60	0.89	13 981	8412	7	10	2.2	7.5
95 mm	10 000	632	600	0.55	0.79	10 103	8443	9	11	1.3	5.1
95 mm	5000	419	480	0.51	0.67	5212	5026	12	14	0.6	2.7
Old	15 000	714	589	0.59	0.88	15 000	9322	7	9	1.8	6.9
Old	10 000	641	627	0.54	0.77	10 293	9180	9	11	1.0	4.5
Old	5000	426	492	0.50	0.64	5255	5110	12	14	0.4	2.1

Table 15.1.3.21 Performance of the 60% CPUE reference point and heavy two-way management response measured against different biological and fishing industry objectives. Table (a) outlines the simulation details, Table (b) summaries the overfishing probabilities and expected median population sizes; the shaded cells indicated scenarios where 5-year biomass ratios B_{t+5}/B_{MSY} , are above one, and Table (c) summaries the expected median catch statistics and mean number of triggered catch-rate reference points; the shaded cells highlight the scenarios that result in the best catches, lowest catch variation, highest fishing effort and catch rates, and the lowest number of catch-rate triggers.

(a) Simulation Details

Trawl Sector: Saucer Scallop; **Model:** Monthly Age Structured; **Recruitment Assumption:** Ricker; **Reference Points:** Limit 60% CPUE; Upper 95 percentile.
Management Response to Triggered Reference Points: For Limit, reduce fishing effort by 30%; For Upper, increase fishing effort by 15%.
Size Limits: 1. Current – Jan to Apr 90 mm and May to Dec 95 mm; 2. 90 mm all year; 3. 95 mm all year; and 4. Old – Nov to Apr 90 mm and May to Aug 95 mm.

(b) Biological Measures

Size Limit	Test Fishing Nights	5yr Probability $B_{t+5}<20\%K$	20yr Probability $B_{t+20}<20\%K$	5yr Probability $B_{t+5}<B_{MSY}$	20yr Probability $B_{t+20}<B_{MSY}$	5yr Biomass Ratio B_{t+5}/K	20yr Biomass Ratio B_{t+20}/K	5yr Biomass Ratio B_{t+5}/B_{MSY}	20yr Biomass Ratio B_{t+20}/B_{MSY}
Current	15 000	<0.01	<0.01	0.53	0.21	0.44	0.64	0.97	1.43
Current	10 000	<0.01	<0.01	0.35	0.22	0.53	0.63	1.15	1.38
Current	5000	<0.01	<0.01	0.13	0.16	0.65	0.68	1.43	1.50
90 mm	15 000	0.01	<0.01	0.62	0.24	0.42	0.63	0.89	1.35
90 mm	10 000	<0.01	<0.01	0.42	0.27	0.51	0.61	1.07	1.29
90 mm	5000	<0.01	<0.01	0.16	0.19	0.64	0.66	1.36	1.39
95 mm	15 000	<0.01	<0.01	0.5	0.19	0.46	0.66	1.00	1.47
95 mm	10 000	<0.01	<0.01	0.33	0.19	0.53	0.65	1.18	1.44
95 mm	5000	<0.01	<0.01	0.12	0.13	0.66	0.71	1.45	1.55
Old	15 000	0.02	<0.01	0.56	0.24	0.42	0.61	0.94	1.35
Old	10 000	<0.01	<0.01	0.37	0.26	0.51	0.60	1.13	1.32
Old	5000	<0.01	<0.01	0.14	0.18	0.64	0.66	1.42	1.43

(c) Fishing Industry Measures

Size Limit	Test Fishing Nights	5yr Catch (t meat)	20yr Catch (t meat)	5yr Catch Variation	20yr Catch Variation	5yr Fishing Nights	20yr Fishing Nights	5yr CPUE (baskets/night)	20yr CPUE (baskets/night)	5yr No. Limit Triggers	20yr No. Limit Triggers	5yr No. Upper Triggers	20yr No. Upper Triggers
Current	15 000	608	405	0.68	1.08	11 306	5145	8	11	1.9	5.0	0.0	0.5
Current	10 000	601	474	0.63	1.02	10 014	5851	9	11	1.2	3.7	0.1	1.0
Current	5000	412	475	0.59	1.00	5263	5741	12	12	0.6	2.2	0.4	2.4
90 mm	15 000	593	393	0.69	1.07	11 208	4365	8	12	2.0	5.2	0.0	0.6
90 mm	10 000	609	474	0.62	1.00	10 090	5685	10	12	1.2	3.7	0.1	0.9
90 mm	5000	427	499	0.58	0.97	5274	5750	12	13	0.5	2.1	0.5	2.5
95 mm	15 000	572	400	0.70	1.09	10 913	4521	8	11	2.1	5.2	0.0	0.5
95 mm	10 000	590	447	0.64	1.05	10 000	5439	9	11	1.3	3.9	0.1	0.9
95 mm	5000	411	461	0.60	1.04	5221	5425	12	12	0.7	2.4	0.4	2.2
Old	15 000	640	422	0.67	1.05	11 568	5210	8	11	1.8	4.9	0.1	0.6
Old	10 000	616	492	0.61	0.99	10 223	7000	9	11	1.0	3.6	0.2	1.0
Old	5000	422	498	0.58	0.98	5292	5839	12	12	0.5	2.0	0.5	2.7

Table 15.1.3.22 Performance of the 60% CPUE reference point and heavy one-way management response measured against different biological and fishing industry objectives. Table (a) outlines the simulation details, Table (b) summaries the overfishing probabilities and expected median population sizes; the shaded cells indicated scenarios where 5-year biomass ratios B_{t+5}/B_{MSY} , are above one, and Table (c) summaries the expected median catch statistics and mean number of triggered catch-rate reference points; the shaded cells highlight the scenarios that result in the best catches, lowest catch variation, highest fishing effort and catch rates, and the lowest number of catch-rate triggers.

(a) Simulation Details

Trawl Sector: Saucer Scallop; Model: Monthly Age Structured; Recruitment Assumption: Ricker; Reference Points: Limit 60% CPUE; No Upper.
Management Response to Triggered Reference Points: For Limit, reduce fishing effort by 30%; No Upper, no increase in fishing effort.
Size Limits: 1. Current – Jan to Apr 90 mm and May to Dec 95 mm; 2. 90 mm all year; 3. 95 mm all year; and 4. Old – Nov to Apr 90 mm and May to Aug 95 mm.

(b) Biological Measures

Size Limit	Test Fishing Nights	5yr Probability $B_{t+5} < 20\%K$	20yr Probability $B_{t+20} < 20\%K$	5yr Probability $B_{t+5} < B_{MSY}$	20yr Probability $B_{t+20} < B_{MSY}$	5yr Biomass Ratio B_{t+5}/K	20yr Biomass Ratio B_{t+20}/K	5yr Biomass Ratio B_{t+5}/B_{MSY}	20yr Biomass Ratio B_{t+20}/B_{MSY}
Current	15 000	<0.01	<0.01	0.53	0.18	0.44	0.66	0.97	1.46
Current	10 000	<0.01	<0.01	0.34	0.15	0.53	0.66	1.16	1.46
Current	5000	<0.01	<0.01	0.13	0.04	0.65	0.77	1.44	1.68
90 mm	15 000	0.01	<0.01	0.62	0.21	0.42	0.65	0.89	1.39
90 mm	10 000	<0.01	<0.01	0.42	0.19	0.51	0.65	1.08	1.39
90 mm	5000	<0.01	<0.01	0.16	0.05	0.64	0.75	1.36	1.60
95 mm	15 000	<0.01	<0.01	0.5	0.16	0.46	0.68	1.00	1.51
95 mm	10 000	<0.01	<0.01	0.33	0.13	0.53	0.68	1.19	1.50
95 mm	5000	<0.01	<0.01	0.12	0.03	0.66	0.78	1.46	1.71
Old	15 000	0.02	<0.01	0.56	0.2	0.42	0.63	0.94	1.41
Old	10 000	<0.01	<0.01	0.37	0.17	0.51	0.64	1.13	1.42
Old	5000	<0.01	<0.01	0.13	0.04	0.64	0.76	1.42	1.66

(c) Fishing Industry Measures

Size Limit	Test Fishing Nights	5yr Catch (t meat)	20yr Catch (t meat)	5yr Catch Variation	20yr Catch Variation	5yr Fishing Nights	20yr Fishing Nights	5yr CPUE (baskets/night)	20yr CPUE (baskets/night)	5yr No. Limit Triggers	20yr No. Limit Triggers
Current	15 000	608	395	0.67	1.05	11 306	5145	8	12	1.9	5.0
Current	10 000	601	461	0.59	0.94	10 000	5629	9	12	1.2	3.7
Current	5000	412	444	0.52	0.76	5222	5000	12	14	0.6	2.2
90 mm	15 000	593	379	0.67	1.06	11 208	4209	8	13	2.0	5.2
90 mm	10 000	609	461	0.59	0.95	10 057	5447	10	13	1.2	3.7
90 mm	5000	426	457	0.51	0.75	5228	5000	13	15	0.5	2.1
95 mm	15 000	572	389	0.69	1.07	10 913	4257	8	12	2.1	5.2
95 mm	10 000	590	436	0.61	0.97	10 000	5227	9	12	1.3	3.9
95 mm	5000	411	431	0.54	0.78	5187	5000	12	14	0.7	2.4
Old	15 000	640	398	0.65	1.04	11 568	5145	8	12	1.8	4.9
Old	10 000	616	491	0.57	0.93	10 203	6257	9	12	1.0	3.5
Old	5000	421	461	0.50	0.74	5242	5020	12	14	0.5	2.0

Table 15.1.3.23 Performance of the 60% CPUE reference point and moderate two-way management response measured against different biological and fishing industry objectives. Table (a) outlines the simulation details, Table (b) summaries the overfishing probabilities and expected median population sizes; the shaded cells indicated scenarios where 5-year biomass ratios B_{t+5}/B_{MSY} , are above one, and Table (c) summaries the expected median catch statistics and mean number of triggered catch-rate reference points; the shaded cells highlight the scenarios that result in the best catches, lowest catch variation, highest fishing effort and catch rates, and the lowest number of catch-rate triggers.

(a) Simulation Details

Trawl Sector: Saucer Scallop; **Model:** Monthly Age Structured; **Recruitment Assumption:** Ricker; **Reference Points:** Limit 60% CPUE; Upper 95 percentile.
Management Response to Triggered Reference Points: For Limit, reduce fishing effort by 10%; For Upper, increase fishing effort by 5%.
Size Limits: 1. Current – Jan to Apr 90 mm and May to Dec 95 mm; 2. 90 mm all year; 3. 95 mm all year; and 4. Old – Nov to Apr 90 mm and May to Aug 95 mm.

(b) Biological Measures

Size Limit	Test Fishing Nights	5yr Probability $B_{t+5} < 20\%K$	20yr Probability $B_{t+20} < 20\%K$	5yr Probability $B_{t+5} < B_{MSY}$	20yr Probability $B_{t+20} < B_{MSY}$	5yr Biomass Ratio B_{t+5}/K	20yr Biomass Ratio B_{t+20}/K	5yr Biomass Ratio B_{t+5}/B_{MSY}	20yr Biomass Ratio B_{t+20}/B_{MSY}
Current	15 000	0.02	0.02	0.6	0.46	0.42	0.48	0.92	1.05
Current	10 000	<0.01	<0.01	0.37	0.29	0.51	0.55	1.13	1.21
Current	5000	<0.01	<0.01	0.14	0.07	0.65	0.70	1.43	1.53
90 mm	15 000	0.03	0.03	0.69	0.54	0.39	0.46	0.84	0.96
90 mm	10 000	<0.01	<0.01	0.44	0.38	0.49	0.53	1.05	1.13
90 mm	5000	<0.01	<0.01	0.17	0.1	0.64	0.68	1.35	1.44
95 mm	15 000	0.02	0.01	0.57	0.41	0.42	0.50	0.93	1.08
95 mm	10 000	<0.01	<0.01	0.36	0.27	0.52	0.57	1.14	1.25
95 mm	5000	<0.01	<0.01	0.12	0.07	0.66	0.71	1.45	1.57
Old	15 000	0.02	0.02	0.62	0.5	0.40	0.45	0.89	1.00
Old	10 000	<0.01	<0.01	0.39	0.33	0.50	0.53	1.11	1.17
Old	5000	<0.01	<0.01	0.14	0.08	0.64	0.68	1.41	1.50

(c) Fishing Industry Measures

Size Limit	Test Fishing Nights	5yr Catch (t meat)	20yr Catch (t meat)	5yr Catch Variation	20yr Catch Variation	5yr Fishing Nights	20yr Fishing Nights	5yr CPUE (baskets/night)	20yr CPUE (baskets/night)	5yr No. Limit Triggers	20yr No. Limit Triggers	5yr No. Upper Triggers	20yr No. Upper Triggers
Current	15 000	699	486	0.55	0.94	14 450	7755	7	9	2.1	7.9	0.0	0.4
Current	10 000	625	550	0.52	0.91	10 184	8156	9	10	1.3	5.1	0.2	1.1
Current	5000	422	482	0.50	0.88	5250	5513	12	13	0.6	2.6	0.4	3.1
90 mm	15 000	694	463	0.55	0.95	14 312	7175	8	10	2.2	8.3	0.0	0.3
90 mm	10 000	638	532	0.52	0.91	10 188	8080	10	11	1.3	5.3	0.1	1.1
90 mm	5000	433	501	0.50	0.87	5262	5556	12	14	0.5	2.5	0.5	3.2
95 mm	15 000	688	477	0.55	0.95	14 030	7296	7	9	2.3	8.2	0.0	0.3
95 mm	10 000	623	535	0.53	0.92	10 017	7894	9	10	1.4	5.5	0.1	1.0
95 mm	5000	419	469	0.50	0.89	5228	5426	12	13	0.7	2.9	0.4	2.8
Old	15 000	701	477	0.54	0.94	14 852	7972	7	9	1.9	7.7	0.1	0.4
Old	10 000	631	556	0.52	0.90	10 274	8743	9	10	1.1	4.9	0.2	1.3
Old	5000	425	496	0.49	0.87	5279	5684	12	13	0.5	2.4	0.5	3.5

Table 15.1.3.24 Performance of the 60% CPUE reference point and moderate one-way management response measured against different biological and fishing industry objectives. Table (a) outlines the simulation details, Table (b) summaries the overfishing probabilities and expected median population sizes; the shaded cells indicated scenarios where 5-year biomass ratios B_{t+5}/B_{MSY} , are above one, and Table (c) summaries the expected median catch statistics and mean number of triggered catch-rate reference points; the shaded cells highlight the scenarios that result in the best catches, lowest catch variation, highest fishing effort and catch rates, and the lowest number of catch-rate triggers.

(a) Simulation Details

Trawl Sector: Saucer Scallop; **Model:** Monthly Age Structured; **Recruitment Assumption:** Ricker; **Reference Points:** Limit 60% CPUE; No Upper.
Management Response to Triggered Reference Points: For Limit, reduce fishing effort by 10%; No Upper, no increase in fishing effort.
Size Limits: 1. Current – Jan to Apr 90 mm and May to Dec 95 mm; 2. 90 mm all year; 3. 95 mm all year; and 4. Old – Nov to Apr 90 mm and May to Aug 95 mm.

(b) Biological Measures

Size Limit	Test Fishing Nights	5yr Probability $B_{t+5} < 20\%K$	20yr Probability $B_{t+20} < 20\%K$	5yr Probability $B_{t+5} < B_{MSY}$	20yr Probability $B_{t+20} < B_{MSY}$	5yr Biomass Ratio B_{t+5}/K	20yr Biomass Ratio B_{t+20}/K	5yr Biomass Ratio B_{t+5}/B_{MSY}	20yr Biomass Ratio B_{t+20}/B_{MSY}
Current	15 000	0.02	0.02	0.6	0.45	0.42	0.48	0.92	1.06
Current	10 000	<0.01	<0.01	0.37	0.26	0.51	0.57	1.13	1.25
Current	5000	<0.01	<0.01	0.14	0.06	0.65	0.73	1.43	1.61
90 mm	15 000	0.03	0.03	0.69	0.53	0.39	0.46	0.84	0.97
90 mm	10 000	<0.01	<0.01	0.44	0.34	0.50	0.55	1.05	1.16
90 mm	5000	<0.01	<0.01	0.17	0.07	0.64	0.72	1.35	1.51
95 mm	15 000	0.02	0.01	0.57	0.4	0.42	0.51	0.93	1.09
95 mm	10 000	<0.01	<0.01	0.36	0.24	0.52	0.59	1.14	1.28
95 mm	5000	<0.01	<0.01	0.12	0.05	0.66	0.75	1.45	1.63
Old	15 000	0.02	0.02	0.62	0.49	0.40	0.47	0.89	1.02
Old	10 000	<0.01	<0.01	0.38	0.3	0.50	0.55	1.11	1.21
Old	5000	<0.01	<0.01	0.14	0.06	0.64	0.72	1.42	1.58

(c) Fishing Industry Measures

Size Limit	Test Fishing Nights	5yr Catch (t meat)	20yr Catch (t meat)	5yr Catch Variation	20yr Catch Variation	5yr Fishing Nights	20yr Fishing Nights	5yr CPUE (baskets/night)	20yr CPUE (baskets/night)	5yr No. Limit Triggers	20yr No. Limit Triggers
Current	15 000	699	486	0.54	0.91	14 450	7725	7	9	2.1	7.9
Current	10 000	625	550	0.51	0.82	10 166	8140	9	10	1.3	5.1
Current	5000	421	466	0.48	0.68	5226	5060	12	13	0.6	2.6
90 mm	15 000	694	463	0.55	0.93	14 312	7175	8	10	2.2	8.3
90 mm	10 000	638	532	0.51	0.83	10 180	8030	10	11	1.3	5.3
90 mm	5000	433	483	0.47	0.68	5233	5089	12	14	0.5	2.5
95 mm	15 000	688	477	0.55	0.92	14 030	7284	7	9	2.3	8.2
95 mm	10 000	623	535	0.52	0.83	10 006	7838	9	10	1.4	5.4
95 mm	5000	419	461	0.48	0.70	5193	5019	12	13	0.7	2.9
Old	15 000	701	477	0.54	0.91	14 852	7972	7	9	1.9	7.7
Old	10 000	631	558	0.50	0.81	10 243	8648	9	10	1.1	4.9
Old	5000	425	476	0.47	0.67	5243	5118	12	13	0.5	2.4

Table 15.1.3.25 Performance of the fishing mortality reference points measured against different biological and fishing industry objectives. Table (a) outlines the simulation details, Table (b) summaries the overfishing probabilities and expected median population sizes; the shaded cells indicated scenarios where 5-year biomass ratios B_{t+5}/B_{MSY} , are above one, and Table (c) summaries the expected median catch statistics and mean number of triggered catch-rate reference points; the shaded cells highlight the scenarios that result in the best catches, lowest catch variation, highest fishing effort and catch rates, and the lowest number of catch-rate triggers.

(a) Simulation Details

Trawl Sector: Saucer Scallop; **Model:** Monthly Age Structured; **Recruitment Assumption:** Beverton-Holt; **Reference Points:** Fishing at E_{MSY} , Fishing at $3/4 E_{MSY}$ and Fishing at $2/3 E_{MSY}$.
Management Response to Triggered Reference Points: Stock assessment ever second year with fishing effort adjusted as required.
Size Limits: 1. Current – Jan to Apr 90 mm and May to Dec 95 mm.

(b) Biological Measures

Test	5yr	20yr	5yr	20yr	5yr	20yr	5yr	20yr
Fishing	Probability	Probability	Probability	Probability	Biomass Ratio	Biomass Ratio	Biomass Ratio	Biomass Ratio
Nights	$B_{t+5} < 20\%K$	$B_{t+20} < 20\%K$	$B_{t+5} < B_{MSY}$	$B_{t+20} < B_{MSY}$	B_{t+5}/K	B_{t+20}/K	B_{t+5}/B_{MSY}	B_{t+20}/B_{MSY}

(c) Fishing Industry Measures

Test	5yr	20yr	5yr	20yr	5yr	20yr
Fishing	Catch	Catch	Catch	Catch	CPUE	CPUE
Nights	(t meat)	(t meat)	Variation	Variation	(baskets/night)	(baskets/night)
E_{MSY}	717	662	0.44	0.60	8	7
$3/4 E_{MSY}$	611	639	0.44	0.54	9	10
$2/3 E_{MSY}$	561	629	0.44	0.52	9	11

Table 15.1.3.26 Performance of status quo fishing measured against different biological and fishing industry objectives. Table (a) outlines the simulation details, Table (b) summaries the overfishing probabilities and expected median population sizes; the shaded cells indicated scenarios where 5-year biomass ratios B_{t+5}/B_{MSY} , are above one, and Table (c) summaries the expected median catch statistics and mean number of triggered catch-rate reference points; the shaded cells highlight the scenarios that result in the best catches, lowest catch variation, highest fishing effort and catch rates, and the lowest number of catch-rate triggers.

(a) Simulation Details

Trawl Sector: Saucer Scallop; **Model:** Monthly Age Structured; **Test Fishing Nights:** 13000; **Reference Points:** None.
Management Response to Triggered Reference Points: None.
Size Limits: 1. Current – Jan to Apr 90 mm and May to Dec 95 mm; 2. 90 mm all year; 3. 95 mm all year; and 4. Old – Nov to Apr 90 mm and May to Aug 95 mm.

(b) Biological Measures

Recruitment	Size Limit	5yr	20yr	5yr	20yr	5yr	20yr	5yr	20yr
		Probability $B_{t+5} < 20\%K$	Probability $B_{t+20} < 20\%K$	Probability $B_{t+5} < B_{MSY}$	Probability $B_{t+20} < B_{MSY}$	Biomass Ratio B_{t+5}/K	Biomass Ratio B_{t+20}/K	Biomass Ratio B_{t+5}/B_{MSY}	Biomass Ratio B_{t+20}/B_{MSY}
Beverton-Holt	Current	0.01	0.19	0.4	0.54	0.45	0.39	1.09	0.93
Beverton-Holt	90 mm	0.02	0.24	0.49	0.63	0.43	0.36	1.01	0.83
Beverton-Holt	95 mm	0.01	0.18	0.39	0.53	0.45	0.40	1.11	0.95
Beverton-Holt	Old	0.02	0.21	0.43	0.56	0.44	0.38	1.08	0.91
Ricker	Current	0.02	0.24	0.56	0.69	0.43	0.35	0.94	0.74
Ricker	90 mm	0.02	0.31	0.65	0.77	0.41	0.31	0.86	0.63
Ricker	95 mm	0.02	0.23	0.54	0.68	0.43	0.35	0.96	0.76
Ricker	Old	0.02	0.26	0.58	0.71	0.42	0.33	0.92	0.71

(c) Fishing Industry Measures

Recruitment	Size Limit	5yr	20yr	5yr	20yr	5yr	20yr
		Catch (t meat)	Catch (t meat)	Catch Variation	Catch Variation	CPUE (baskets/night)	CPUE (baskets/night)
Beverton-Holt	Current	718	679	0.56	0.75	8	7
Beverton-Holt	90 mm	716	658	0.57	0.78	8	7
Beverton-Holt	95 mm	721	685	0.55	0.75	8	7
Beverton-Holt	Old	715	672	0.56	0.76	8	7
Ricker	Current	693	583	0.54	0.80	8	6
Ricker	90 mm	696	549	0.54	0.84	8	6
Ricker	95 mm	695	589	0.54	0.79	8	6
Ricker	Old	693	568	0.54	0.81	8	6

Table 15.1.3.27 Performance of the 80% CPUE reference point and one-way management responses measured against different biological and fishing industry objectives. Table (a) outlines the simulation details, Table (b) summaries the overfishing probabilities and expected median population sizes; the shaded cells indicated scenarios where 5-year biomass ratios B_{t+5}/B_{MSY} , are above one, and Table (c) summaries the expected median catch statistics and mean number of triggered catch-rate reference points; the shaded cells highlight the scenarios that result in the best catches, lowest catch variation, highest fishing effort and catch rates, and the lowest number of catch-rate triggers.

(a) Simulation Details

Trawl Sector: Saucer Scallop; **Model:** Schaefer Surplus Production; **Reference Points:** Limit 80% CPUE; No Upper.
Management Response to Triggered Reference Points: None; 10% - reduce fishing effort by 10%; 30% - reduce fishing effort by 10%;

(b) Biological Measures

Management Response for Ref. Pts	Test Fishing Nights	5yr Probability $B_{t+5} < 20\%K$	20yr Probability $B_{t+20} < 20\%K$	5yr Probability $B_{t+5} < B_{MSY}$	20yr Probability $B_{t+20} < B_{MSY}$	5yr Biomass Ratio B_{t+5}/K	20yr Biomass Ratio B_{t+20}/K	5yr Biomass Ratio B_{t+5}/B_{MSY}	20yr Biomass Ratio B_{t+20}/B_{MSY}
None	15 000	0.01	<0.01	0.37	0.45	0.50	0.48	0.97	0.95
None	10 000	<0.01	<0.01	0.02	0.02	0.65	0.64	1.27	1.26
None	5000	<0.01	<0.01	<0.01	<0.01	0.80	0.79	1.57	1.56
10%	15 000	<0.01	<0.01	0.34	0.42	0.49	0.49	0.97	0.96
10%	10 000	<0.01	<0.01	0.02	0.02	0.65	0.64	1.27	1.26
10%	5000	<0.01	<0.01	<0.01	<0.01	0.80	0.79	1.57	1.56
30%	15 000	<0.01	<0.01	0.32	0.35	0.50	0.50	0.98	0.97
30%	10 000	<0.01	<0.01	0.02	0.02	0.65	0.64	1.28	1.26
30%	5000	<0.01	<0.01	<0.01	<0.01	0.80	0.80	1.57	1.57

(c) Fishing Industry Measures

Management Response for Ref. Pts	Test Fishing Nights	5yr Catch (t meat)	20yr Catch (t meat)	5yr Catch Variation	20yr Catch Variation	5yr Fishing Nights	20yr Fishing Nights	5yr CPUE (baskets/night)	20yr CPUE (baskets/night)	5yr No. Limit Triggers	20yr No. Limit Triggers
None	15 000	1220	1168	0.12	0.07	14 797	14 786	12	12	0.3	0.9
None	10 000	995	1011	0.01	0.01	9862	9862	16	16	0.1	0.1
None	5000	585	619	0.09	0.05	4931	4932	20	20	0.1	0.1
10%	15 000	1218	1170	0.12	0.06	14 762	14 737	12	12	0.2	0.3
10%	10 000	994	1011	0.01	0.01	9863	9858	16	16	0.1	0.1
10%	5000	585	618	0.09	0.05	4925	4931	20	20	0.1	0.1
30%	15 000	1218	1168	0.12	0.06	14 768	14 743	12	12	0.2	0.3
30%	10 000	995	1011	0.01	0.01	9864	9860	16	16	0.1	0.1

Table 15.1.3.28 Performance of the 70% CPUE reference point and one-way management responses measured against different biological and fishing industry objectives. Table (a) outlines the simulation details, Table (b) summaries the overfishing probabilities and expected median population sizes; the shaded cells indicated scenarios where 5-year biomass ratios B_{t+5}/B_{MSY} , are above one, and Table (c) summaries the expected median catch statistics and mean number of triggered catch-rate reference points; The shaded cells highlight the scenarios that result in the best catches, lowest catch variation, highest fishing effort and catch rates, and the lowest number of catch-rate triggers.

(a) Simulation Details

Trawl Sector: Saucer Scallop; **Model:** Schaefer Surplus Production; **Reference Points:** Limit 70% CPUE; No Upper.
Management Response to Triggered Reference Points: None; 10% – reduce fishing effort by 10%; 30% – reduce fishing effort by 10%;

(b) Biological Measures

Management Response for Ref. Pts	Test Fishing Nights	5yr Probability $B_{t+5} < 20\%K$	20yr Probability $B_{t+20} < 20\%K$	5yr Probability $B_{t+5} < B_{MSY}$	20yr Probability $B_{t+20} < B_{MSY}$	5yr Biomass Ratio B_{t+5}/K	20yr Biomass Ratio B_{t+20}/K	5yr Biomass Ratio B_{t+5}/B_{MSY}	20yr Biomass Ratio B_{t+20}/B_{MSY}
None	15 000	0.01	<0.01	0.37	0.45	0.49	0.48	0.97	0.95
None	10 000	<0.01	<0.01	0.02	0.02	0.65	0.64	1.27	1.26
None	5000	<0.01	<0.01	<0.01	<0.01	0.80	0.79	1.57	1.56
10%	15 000	<0.01	<0.01	0.36	0.44	0.49	0.48	0.97	0.95
10%	10 000	<0.01	<0.01	0.02	0.02	0.65	0.64	1.27	1.26
10%	5000	<0.01	<0.01	<0.01	<0.01	0.79	0.79	1.56	1.56
30%	15 000	<0.01	<0.01	0.34	0.43	0.49	0.49	0.97	0.96
30%	10 000	<0.01	<0.01	0.02	0.02	0.65	0.64	1.28	1.26
30%	5000	<0.01	<0.01	<0.01	<0.01	0.80	0.79	1.57	1.56

(c) Fishing Industry Measures

Management Response for Ref. Pts	Test Fishing Nights	5yr Catch (t meat)	20yr Catch (t meat)	5yr Catch Variation	20yr Catch Variation	5yr Fishing Nights	20yr Fishing Nights	5yr CPUE (baskets/night)	20yr CPUE (baskets/night)	5yr No. Limit Triggers	20yr No. Limit Triggers
None	15 000	1220	1169	0.13	0.07	14 792	14 783	12	12	0.1	0.3
None	10 000	994	1011	0.01	0.01	9857	9857	16	16	0.1	0.1
None	5000	585	619	0.09	0.05	4932	4929	20	20	0.1	0.1
10%	15 000	1220	1169	0.13	0.07	14 777	14 772	12	12	0.1	0.2
10%	10 000	994	1011	0.01	0.01	9857	9851	16	16	0.1	0.1
10%	5000	585	618	0.09	0.05	4929	4931	20	20	0.1	0.1
30%	15 000	1220	1169	0.13	0.07	14 769	14 774	12	12	0.1	0.2
30%	10 000	995	1011	0.01	0.01	9858	9851	16	16	0.1	0.1

Table 15.1.3.29 Performance of the 60% CPUE reference point and one-way management responses measured against different biological and fishing industry objectives. Table (a) outlines the simulation details, Table (b) summaries the overfishing probabilities and expected median population sizes; the shaded cells indicated scenarios where 5-year biomass ratios B_{t+5}/B_{MSY} , are above one, and Table (c) summaries the expected median catch statistics and mean number of triggered catch-rate reference points; the shaded cells highlight the scenarios that result in the best catches, lowest catch variation, highest fishing effort and catch rates, and the lowest number of catch-rate triggers.

(a) Simulation Details

Trawl Sector: Saucer Scallop; **Model:** Schaefer Surplus Production; **Reference Points:** Limit 60% CPUE; No Upper.
Management Response to Triggered Reference Points: None; 10% – reduce fishing effort by 10%; 30% – reduce fishing effort by 10%.

(b) Biological Measures

Management Response for Ref. Pts	Test Fishing Nights	5yr Probability $B_{t+5}<20\%K$	20yr Probability $B_{t+20}<20\%K$	5yr Probability $B_{t+5}<B_{MSY}$	20yr Probability $B_{t+20}<B_{MSY}$	5yr Biomass Ratio B_{t+5}/K	20yr Biomass Ratio B_{t+20}/K	5yr Biomass Ratio B_{t+5}/B_{MSY}	20yr Biomass Ratio B_{t+20}/B_{MSY}
None	15 000	0.01	<0.01	0.36	0.44	0.49	0.48	0.97	0.95
None	10 000	<0.01	<0.01	0.02	0.02	0.65	0.64	1.27	1.26
None	5000	<0.01	<0.01	<0.01	<0.01	0.80	0.80	1.57	1.57
10%	15 000	<0.01	<0.01	0.36	0.44	0.49	0.48	0.97	0.95
10%	10 000	<0.01	<0.01	0.02	0.02	0.65	0.64	1.27	1.26
10%	5000	<0.01	<0.01	<0.01	<0.01	0.79	0.79	1.56	1.56
30%	15 000	<0.01	<0.01	0.36	0.43	0.49	0.48	0.97	0.95
30%	10 000	<0.01	<0.01	0.02	0.02	0.65	0.64	1.27	1.26
30%	5000	<0.01	<0.01	<0.01	<0.01	0.79	0.80	1.56	1.57

(c) Fishing Industry Measures

Management Response for Ref. Pts	Test Fishing Nights	5yr Catch (t meat)	20yr Catch (t meat)	5yr Catch Variation	20yr Catch Variation	5yr Fishing Nights	20yr Fishing Nights	5yr CPUE (baskets/night)	20yr CPUE (baskets/night)	5yr No. Limit Triggers	20yr No. Limit Triggers
None	15 000	1218	1168	0.13	0.07	14 800	14 784	12	12	0.1	0.2
None	10 000	995	1011	0.01	0.01	9866	9864	16	16	0.1	0.1
None	5000	585	619	0.09	0.05	4928	4932	20	20	0.1	0.1
10%	15 000	1218	1169	0.13	0.07	14 774	14 791	12	12	0.1	0.1
10%	10 000	994	1011	0.01	0.01	9864	9862	16	16	0.1	0.1
10%	5000	586	618	0.09	0.05	4931	4929	20	20	0.1	0.1
30%	15 000	1220	1169	0.13	0.07	14 785	14 773	12	12	0.1	0.1
30%	10 000	995	1011	0.01	0.01	9853	9855	16	16	0.1	0.1

15.2 GOODNESS OF FIT PLOTS FOR CHAPTER 6.

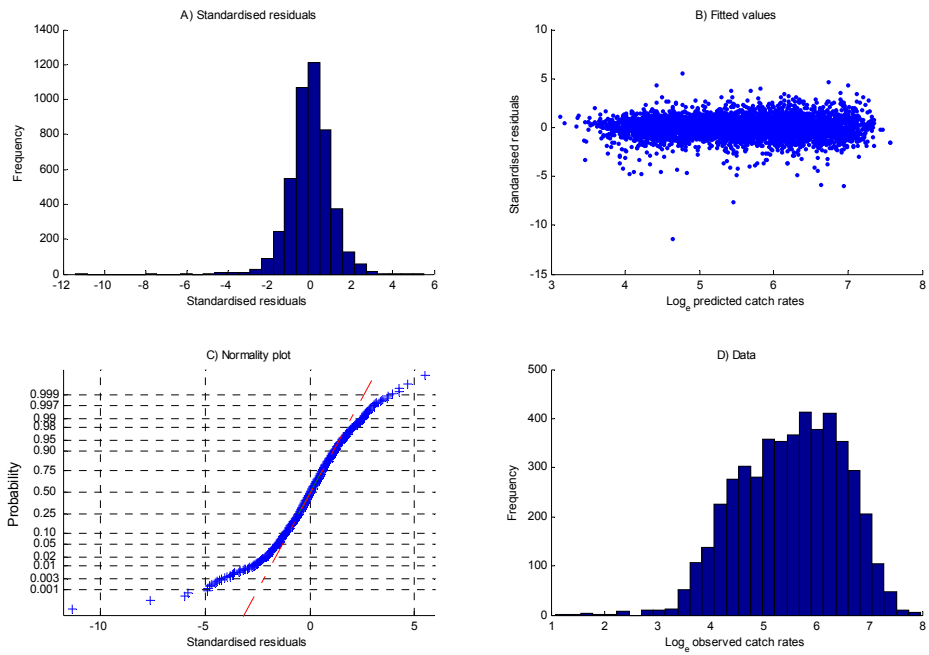

Figure 15.2.1 Standardised residuals for deep water eastern king prawns.

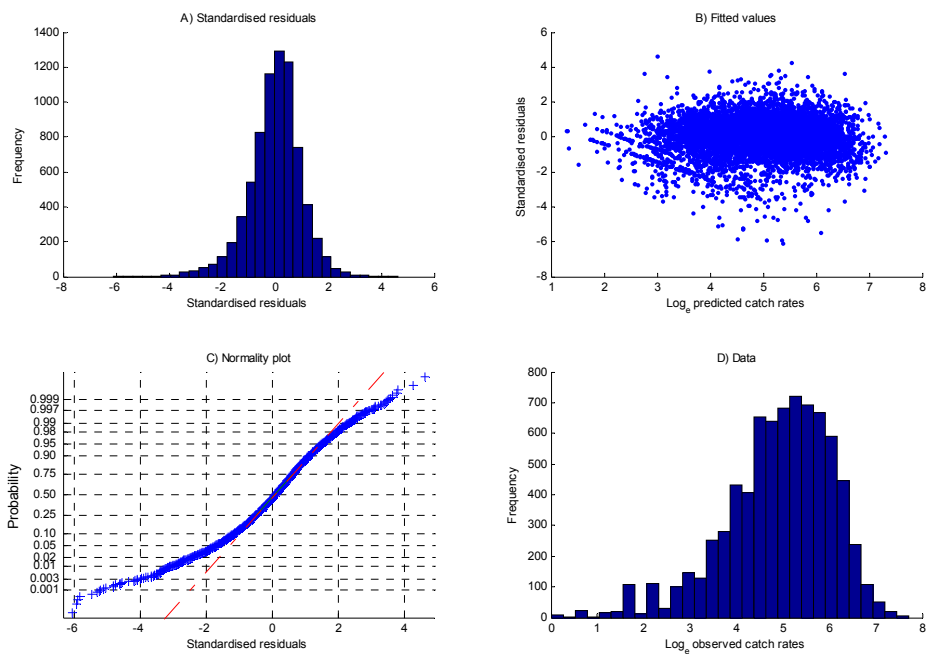

Figure 15.2.2 Standardised residuals for shallow water eastern king prawns.

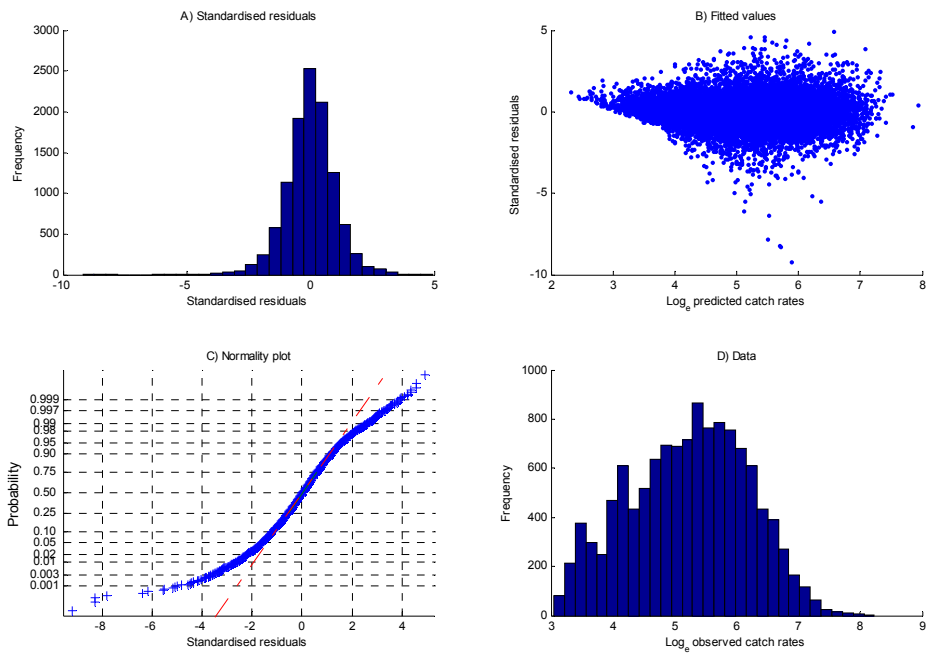

Figure 15.2.3 Standardised residuals for north Queensland tiger prawns.

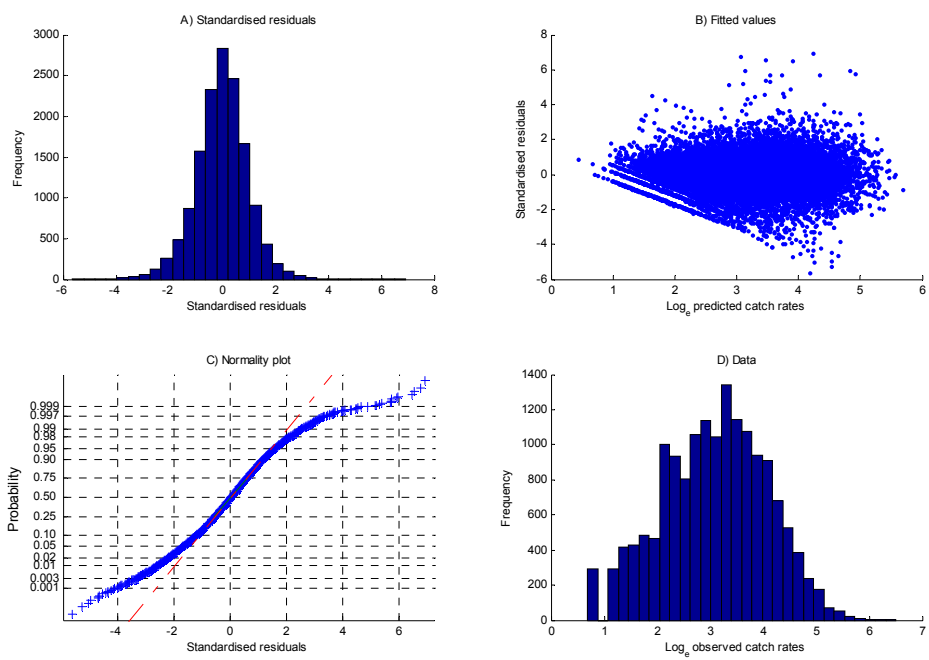

Figure 15.2.4 Standardised residuals for saucer scallops.

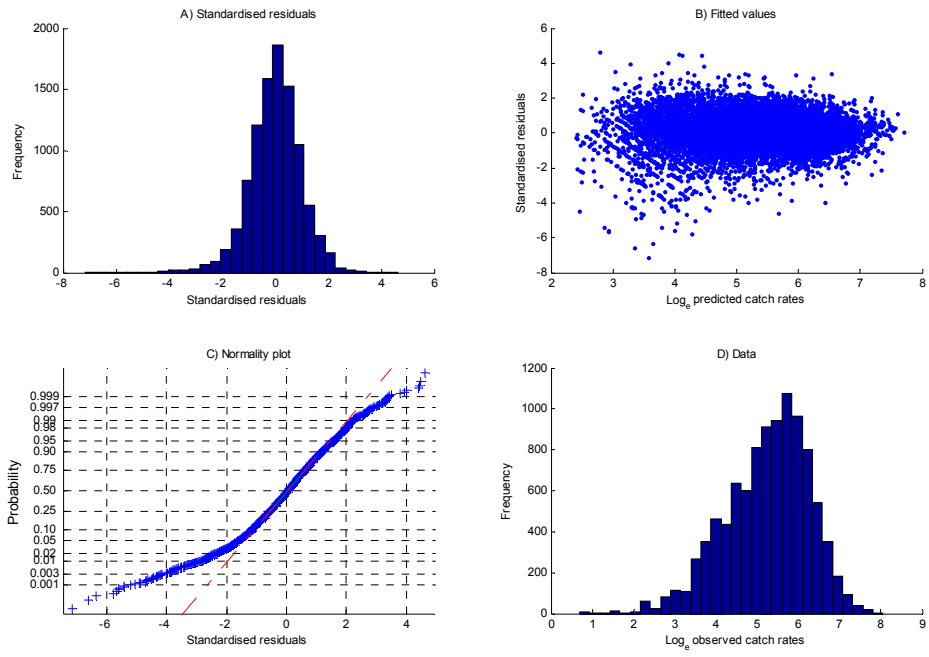
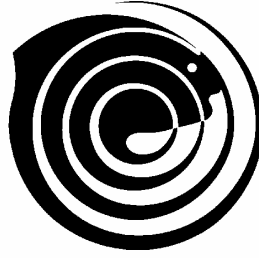

Figure 15.2.5 Standardised residuals for Torres Strait tiger prawns.



**Queensland
Government**
Department of
**Primary Industries
and Fisheries**



**F I S H E R I E S
R E S E A R C H &
D E V E L O P M E N T
C O R P O R A T I O N**

Survey of Queensland Commercial Trawl Vessels December 2002

This questionnaire relates to the following vessel ONLY

.....(Vessel name)

.....(Vessel symbol)

Answering the Questionnaire

This questionnaire applies only to the vessel listed on the cover. All the questions you answer should apply only to this vessel. If you own or are responsible for more vessels, you may receive another questionnaire for each of these vessels.

The questionnaire will provide information to establish the catching ability of your vessel. The questions enclosed are designed to record the historical change in your vessel and fishing gear characteristics. Completion of this questionnaire is essential to the success of this Fisheries Research and Development Corporation (FRDC) and Queensland Department of Primary Industries (QDPI) funded project. This research has been fully endorsed by representatives from the following organisations FRDC, QCFO, QDPI and TrawlMAC.

In you return the completed questionnaire by the due date listed below, we would be pleased to provide you with information on how much the catching ability of your fishery has changed due to the use of GPS, plotters, engine power etc.

Your information will help QDPI provide the fishing industry with an improved assessment of prawn and scallop resources, resulting in more accurate management decisions and movement towards optimal fisheries production and hence avoid having overly conservative management policy.

Confidentiality

Individual vessel owners'/operators' information will be treated as strictly confidential. No individual or business will be able to be identified from the results in any reports. Your individual information will be entered onto an electronic database that has restricted access.

Due Date

The Queensland Department of Primary Industries will contact you in a month if you have not returned this questionnaire.

Return of Questionnaire

Once you have completed the questionnaire, please return it in the mail using the enclosed reply-paid envelope.

Mail to – 'Confidential', Mr M. O'Neill, Reply Paid No. 444, PO Box 76, Deception Bay, Qld, 4508

Important Note

Please provide dates on all vessel/gear changes where possible. This information is very important for us to understand the changes that occurred in your fishery over time. If a question does not accommodate your vessel/gear set up, please specify in your own words on the back of the question page. If exact figures are not available please provide careful estimates. If you don't know some details please write '**DON'T KNOW**' for the question. If you have any other problems in completing this questionnaire, or feel that you may have difficulties meeting the due date, please contact the Southern Fisheries Stock Assessment group by:

Telephone – 07 3817 9500, 3817 9529, 3817 9595, 3817 9582

Facsimile – 07 3817 9555

E-mail – oneillm@dpi.qld.gov.au

When filling out the Questionnaire, please record dates like the following example for August 1990

8 / **19** **90**
/19..... (M/Y)

Your Contact Details

Who should be contacted if queries arise regarding this questionnaire?

Name..... Telephone No. (.....).....

Most convenient time and day for us to telephone you if necessary : : , (day)

1. Vessel Specifications

The following vessel details are required to determine how effectively your vessel can tow trawl gear. Please provide information on changes to the vessel listed on the cover for the period from **purchase date to 31st December 1999**. If certain vessel specifications have changed more than twice, please record this information on **the back of page**. If exact figures or dates are not available please provide careful estimates. If you just don't know some details please write down **'DON'T KNOW'**.

When did you purchase this vessel?/ 19.....(Month / Year)

Which fisheries has this vessel operated in since you purchased the vessel? Also, how have you been related to the skipper(s)? Please tick the relevant box for each fishery. If there was more than one type of skipper, please record the years operated by each skipper.

(Tick correct box)	Fishery	Owner-Skipper	Related Family Member	Non-Family Employee	Other
1. Eastern King Prawns (not red spot or blue leg)	No <input type="checkbox"/>	<input type="checkbox"/>	<input type="checkbox"/>	<input type="checkbox"/>	<input type="checkbox"/>
	Yes <input type="checkbox"/> <input checked="" type="checkbox"/> (year to year) (year to year) (year to year) (year to year)
2. Tiger / Endeavour Prawns	No <input type="checkbox"/>	<input type="checkbox"/>	<input type="checkbox"/>	<input type="checkbox"/>	<input type="checkbox"/>
	Yes <input type="checkbox"/> <input checked="" type="checkbox"/> (year to year) (year to year) (year to year) (year to year)
3. Saucer Scallops	No <input type="checkbox"/>	<input type="checkbox"/>	<input type="checkbox"/>	<input type="checkbox"/>	<input type="checkbox"/>
	Yes <input type="checkbox"/> <input checked="" type="checkbox"/> (year to year) (year to year) (year to year) (year to year)

<u>Vessel Specifications</u>	When you first fished with this vessel.	Provide details of any changes that have been made during your ownership/operation, with the first change in gear recorded first.
1. Engine manufacturer(type)(type)/ 19..... (Month / Year)
2. Engine Rated Power—(hp or kW)(hp).....(kW)(hp).....(kW)
3. Engine Rated RPM(RPM)(RPM)
4. Maximum trawling RPM(RPM)(RPM)
5. Normal trawling RPM		
Eastern King Prawns(RPM)(RPM)
Tiger / Endeavour Prawns(RPM)(RPM)
Saucer Scallops(RPM)(RPM)
6. Normal trawling speed for —		
Eastern King Prawns(knots)(knots)
Tiger / Endeavour Prawns(knots)(knots)
Saucer Scallops(knots)(knots)
7. Steaming speed (knots)(knots)(knots)
8. Reduction :1 :1/19.....(Month/Year)
9. Max. Fuel Capacity (litres)(l)(l)/19..... M/Y
10. Fuel Consumption (litres per night)(litres per night)(l)/19..... M/Y
11. Propeller Diameter (inches or cm)(in).....(cm)(in).....(cm)/19..... M/Y
12. Propeller Pitch (inches)(in)(in)/19..... M/Y
13. Kortz Nozzle (tick box)	Yes <input type="checkbox"/> No <input type="checkbox"/>	Yes <input type="checkbox"/>/ 19..... M/Y installed

1. Vessel Specifications: continued. (complete only if you have changed vessel specifications more than twice)

<u>Vessel Specifications</u>	Additional Changes	Additional Changes
1. Engine manufacturer(type)/ 19..... (Month / Year)(type)/ 19..... (Month / Year)
2. Engine Rated Power–(hp or kW)(hp).....(kW)(hp).....(kW)
3. Engine Rated <i>RPM</i>(RPM)(RPM)
4. Maximum trawling <i>RPM</i>(RPM)(RPM)
5. Normal trawling <i>RPM</i>		
Eastern King Prawns(RPM)(RPM)
Tiger / Endeavour Prawns(RPM)(RPM)
Saucer Scallops(RPM)(RPM)
6. Normal trawling speed for -		
Eastern King Prawns(knots)(knots)
Tiger / Endeavour Prawns(knots)(knots)
Saucer Scallops(knots)(knots)
7. Steaming speed (knots)(knots)(knots)
8. Reduction :1/19..... M/Y :1/19..... M/Y
9. Max. Fuel Capacity (litres)(l)/19..... M/Y(l)/19..... M/Y
10. Fuel Consumption (litres per night)(l)/19..... M/Y(l)/19..... M/Y
11. Propeller Diameter (inches or <i>cm</i>)(in).....(cm)/19..... M/Y(in).....(cm)/19..... M/Y
12. Propeller Pitch (inches) (“)/19..... M/Y (“)/19..... M/Y
13. Kortz Nozzle (tick box)	Yes <input type="checkbox"/>/19..... M/Y installed	Yes <input type="checkbox"/>/19..... M/Y installed

Navigation Capabilities

One of the most important aspects to fishing is the ability to find and trawl the most productive areas. Specialised navigation equipment plays an important role in identifying and returning to productive fishing grounds. Please provide the following details for the vessel listed on the cover. If exact dates are not available please provide careful estimates. If you just don't know some details please write 'DON'T KNOW' for the question.

<u>Navigation equipment</u>	Has the equipment ever been used on the vessel? (Tick one box for each question. Please provide month/year if equipment was installed after the vessel was purchased)	Has the equipment been updated or retired since first use? (please provide month/year of change)
1. Colour Echo sounder	<input type="checkbox"/> No <input type="checkbox"/> Yes, already installed when vessel purchased <input type="checkbox"/> Yes, installed after vessel purchased (...../ 19.....)	<input type="checkbox"/> 1 st update...../19..... <input type="checkbox"/> 2 nd update...../19..... <input type="checkbox"/> retired/19.....
2. Sonar	<input type="checkbox"/> No <input type="checkbox"/> Yes, already installed when vessel purchased <input type="checkbox"/> Yes, installed after vessel purchased (...../ 19.....)	<input type="checkbox"/> 1 st update...../19..... <input type="checkbox"/> 2 nd update...../19..... <input type="checkbox"/> retired/19.....
3. Radar	<input type="checkbox"/> No <input type="checkbox"/> Yes, already installed when vessel purchased <input type="checkbox"/> Yes, installed after vessel purchased (...../ 19.....)	<input type="checkbox"/> 1 st update...../19..... <input type="checkbox"/> 2 nd update...../19..... <input type="checkbox"/> retired/19.....
4. Satellite Navigation (SatNav)	<input type="checkbox"/> No <input type="checkbox"/> Yes, already installed when vessel purchased <input type="checkbox"/> Yes, installed after vessel purchased (...../ 19.....)	<input type="checkbox"/> 1 st update...../19..... <input type="checkbox"/> 2 nd update...../19..... <input type="checkbox"/> retired/19.....
5. Global Positioning System (GPS)	<input type="checkbox"/> No <input type="checkbox"/> Yes, already installed when vessel purchased <input type="checkbox"/> Yes, installed after vessel purchased (...../ 19.....)	<input type="checkbox"/> 1 st update...../19..... <input type="checkbox"/> 2 nd update...../19..... <input type="checkbox"/> retired/19.....
6. Differential GPS (DGPS)	<input type="checkbox"/> No <input type="checkbox"/> Yes, already installed when vessel purchased <input type="checkbox"/> Yes, installed after vessel purchased (...../ 19.....)	<input type="checkbox"/> 1 st update...../19..... <input type="checkbox"/> 2 nd update...../19..... <input type="checkbox"/> retired/19.....
7. Plotter (interfaced with GPS)	<input type="checkbox"/> No <input type="checkbox"/> Yes, already installed when vessel purchased <input type="checkbox"/> Yes, installed after vessel purchased (...../ 19.....)	<input type="checkbox"/> 1 st update...../19..... <input type="checkbox"/> 2 nd update...../19..... <input type="checkbox"/> retired/19.....
8. Autopilot	<input type="checkbox"/> No <input type="checkbox"/> Yes, already installed when vessel purchased <input type="checkbox"/> Yes, installed after vessel purchased (...../ 19.....)	<input type="checkbox"/> 1 st update...../19..... <input type="checkbox"/> 2 nd update...../19..... <input type="checkbox"/> retired/19.....
9. GPS interfaced with the autopilot	<input type="checkbox"/> No <input type="checkbox"/> Yes, already installed when vessel purchased <input type="checkbox"/> Yes, installed after vessel purchased (...../ 19.....)	<input type="checkbox"/> 1 st update...../19..... <input type="checkbox"/> 2 nd update...../19..... <input type="checkbox"/> retired/19.....
10. Radar interfaced with the GPS/Plotter	<input type="checkbox"/> No <input type="checkbox"/> Yes, already installed when vessel purchased <input type="checkbox"/> Yes, installed after vessel purchased (...../ 19.....)	<input type="checkbox"/> 1 st update...../19..... <input type="checkbox"/> 2 nd update...../19..... <input type="checkbox"/> retired/19.....
11. GPS interfaced with computer mapping software e.g. CPLOT.	<input type="checkbox"/> No <input type="checkbox"/> Yes, already installed when vessel purchased <input type="checkbox"/> Yes, installed after vessel purchased (...../ 19.....)	<input type="checkbox"/> 1 st update...../19..... <input type="checkbox"/> 2 nd update...../19..... <input type="checkbox"/> retired/19.....

Communication devices

The ability to communicate with other vessels could influence where you fish. This is just another aspect how technology could influence your catch rates and play an important role to identify productive fishing grounds. Please provide the details of communication equipment installed or carried on the vessel listed on the cover. If exact dates/figures are not available please provide careful estimates. If you just don't know some details please write 'DON'T KNOW' for the question.

<u>Communication Devices</u>	Has the equipment ever been used on the vessel? (Tick one box for each question. Please provide month/year if equipment was used after the vessel was purchased)	What is the relative amount you use each device to communicate at present?	
		From vessel to vessel? (per 100 communications)	From vessel to shore? (per 100 communications)
1. HF Radio	<input type="checkbox"/> No <input type="checkbox"/> Yes, already used when vessel purchased <input type="checkbox"/> Yes, but first used after the vessel was purchased./ 19..... (month / year)	<input type="checkbox"/> No <input type="checkbox"/> less than 25% <input type="checkbox"/> 25 to 50% <input type="checkbox"/> 50 to 75% <input type="checkbox"/> more than 75%	<input type="checkbox"/> No <input type="checkbox"/> less than 25% <input type="checkbox"/> 25 to 50% <input type="checkbox"/> 50 to 75% <input type="checkbox"/> more than 75%
2. VHF Radio	<input type="checkbox"/> No <input type="checkbox"/> Yes, already used when vessel purchased <input type="checkbox"/> Yes, but first used after the vessel was purchased./ 19..... (month / year)	<input type="checkbox"/> No <input type="checkbox"/> less than 25 % <input type="checkbox"/> 25 to 50 % <input type="checkbox"/> 50 to 75 % <input type="checkbox"/> more than 75%	<input type="checkbox"/> No <input type="checkbox"/> less than 25 % <input type="checkbox"/> 25 to 50 % <input type="checkbox"/> 50 to 75 % <input type="checkbox"/> more than 75%
3. UHF Radio	<input type="checkbox"/> No <input type="checkbox"/> Yes, already used when vessel purchased <input type="checkbox"/> Yes, but first used after the vessel was purchased./ 19..... (month / year)	<input type="checkbox"/> No <input type="checkbox"/> less than 25% <input type="checkbox"/> 25 to 50% <input type="checkbox"/> 50 to 75% <input type="checkbox"/> more than 75%	<input type="checkbox"/> No <input type="checkbox"/> less than 25% <input type="checkbox"/> 25 to 50% <input type="checkbox"/> 50 to 7 % <input type="checkbox"/> more than 75%
4. 27 meg Marine Radio	<input type="checkbox"/> No <input type="checkbox"/> Yes, already used when vessel purchased <input type="checkbox"/> Yes, but first used after the vessel was purchased./ 19..... (month / year)	<input type="checkbox"/> No <input type="checkbox"/> less than 25% <input type="checkbox"/> 25 to 50% <input type="checkbox"/> 50 to 75% <input type="checkbox"/> more than 75%	<input type="checkbox"/> No <input type="checkbox"/> less than 25% <input type="checkbox"/> 25 to 50% <input type="checkbox"/> 50 to 75% <input type="checkbox"/> more than 75%
5. Mobile phone	<input type="checkbox"/> No <input type="checkbox"/> Yes, already used when vessel purchased <input type="checkbox"/> Yes, but first used after the vessel was purchased./ 19..... (month / year)	<input type="checkbox"/> No <input type="checkbox"/> less than 25% <input type="checkbox"/> 25 to 50% <input type="checkbox"/> 50 to 75% <input type="checkbox"/> more than 75%	<input type="checkbox"/> No <input type="checkbox"/> less than 25% <input type="checkbox"/> 25 to 50% <input type="checkbox"/> 50 to 75% <input type="checkbox"/> more than 75%
6. Satellite phone	<input type="checkbox"/> No <input type="checkbox"/> Yes, already used when vessel purchased <input type="checkbox"/> Yes, but first used after the vessel was purchased./ 19..... (month / year)	<input type="checkbox"/> No <input type="checkbox"/> less than 25% <input type="checkbox"/> 25 to 50% <input type="checkbox"/> 50 to 75% <input type="checkbox"/> more than 75%	<input type="checkbox"/> No <input type="checkbox"/> less than 25% <input type="checkbox"/> 25 to 50% <input type="checkbox"/> 50 to 75% <input type="checkbox"/> more than 75%
7. Others (please specify)	<input type="checkbox"/> No <input type="checkbox"/> Yes, already used when vessel purchased <input type="checkbox"/> Yes, but first used after the vessel was purchased./ 19..... (month / year)	<input type="checkbox"/> No <input type="checkbox"/> less than 25% <input type="checkbox"/> 25 to 50% <input type="checkbox"/> 50 to 75% <input type="checkbox"/> more than 75%	<input type="checkbox"/> No <input type="checkbox"/> less than 25% <input type="checkbox"/> 25 to 50% <input type="checkbox"/> 50 to 75% <input type="checkbox"/> more than 75%
8. Others (please specify)	<input type="checkbox"/> No <input type="checkbox"/> Yes, already used when vessel purchased <input type="checkbox"/> Yes, but first used after the vessel was purchased./ 19..... (month / year)	<input type="checkbox"/> No <input type="checkbox"/> less than 25% <input type="checkbox"/> 25 to 50% <input type="checkbox"/> 50 to 75% <input type="checkbox"/> more than 75%	<input type="checkbox"/> No <input type="checkbox"/> less than 25% <input type="checkbox"/> 25 to 50% <input type="checkbox"/> 50 to 75% <input type="checkbox"/> more than 75%

Do you use any other communication devices? E.g. E-mail, CB radio, Fax etc

6. Trawl Gear Types

The trawl gear essentially determines how effectively a vessel fishes, especially by changing swept area. The setup of trawl gear varies with vessels and many different net types are used. Information on trawl-gear is required to classify vessels into groups with similar configurations.

The following four pages (one for each fishery – marked at top of page) are designed for you to record information on trawl-gear starting from when you first fished with the vessel until 31st December 1999. **Please complete only the relevant tables for the fisheries the vessel fished in during your ownership/operation.**

All questions relate to the main trawl nets, not the cod-end.

- The first column is for you to record the **original** trawl gear when you first started fishing with the vessel listed on the cover.
- The next three columns are for you to record any changes from the original gear. **Please record the new details and the month/year when the change occurred.** If there were more than three changes, please record details on the back of the page.



The Eastern King Prawn Fishery (Inshore Waters shallower than 50 fathoms)

<u>Trawl-Gear</u> Please answer questions row by row.	When you first fished with this vessel	Provide details of any gear changes that have been made during your ownership/operation.		
1. Net Type (Please tick one box) Single..... <input type="checkbox"/> Double..... <input type="checkbox"/> Triple..... <input type="checkbox"/> Quad..... <input type="checkbox"/> Five..... <input type="checkbox"/> Please specify Month/Year of changes				
2. Total Net Head Rope Length(fm) Please specify Month/Year of changes				
3. Net mesh size (inches) (in) Please specify Month/Year of changes				
4. Did/Do you use knotless mesh? <input type="checkbox"/> No <input type="checkbox"/> Yes				
5. Ground Gear Type (tick box) Drop chain..... <input type="checkbox"/> Drop mud rope..... <input type="checkbox"/> Drop chain with sliding rings..... <input type="checkbox"/> Danglers or Christmas-tree drops... <input type="checkbox"/> Looped ground chain..... <input type="checkbox"/> Drop rope with chain..... <input type="checkbox"/> Other (please specify)..... Please Specify Month/Year of changes				
6. Ground line specification Maximum gauge of chain (mm) Style of chain link (please circle one style) Do you use Stainless steel chain? <input type="checkbox"/> Yes <input type="checkbox"/> No Please Specify Month/Year of changes				
7. Otter-boards types (tick box) Bison..... <input type="checkbox"/> Louvre..... <input type="checkbox"/> Flat Timber..... <input type="checkbox"/> Flat Timber-steel <input type="checkbox"/> Kilfoil..... <input type="checkbox"/> Collins..... <input type="checkbox"/> Other (please specify)..... Please specify Month/Year of changes				
8. Otter-board dimensions Length (feet)..... Height (feet)..... Please Specify Month/Year of changes				

The Eastern King Prawn Fishery
(Offshore Waters deeper than 50 fathoms)

<u>Trawl-Gear</u> Please answer questions row by row.	When you first fished with this vessel	Provide details of any gear changes that have been made during your ownership/operation.			
9. Net Type (Please tick one box) Single..... Double..... Triple..... Quad..... Five..... Please specify Month/Year of changes <input type="checkbox"/> <input type="checkbox"/> <input type="checkbox"/> <input type="checkbox"/> <input type="checkbox"/> <input type="checkbox"/> <input type="checkbox"/> <input type="checkbox"/> <input type="checkbox"/> <input type="checkbox"/>/19..... M/Y <input type="checkbox"/> <input type="checkbox"/> <input type="checkbox"/> <input type="checkbox"/> <input type="checkbox"/>/19..... M/Y <input type="checkbox"/> <input type="checkbox"/> <input type="checkbox"/> <input type="checkbox"/> <input type="checkbox"/>/19..... M/Y	
10. Total Net Head Rope Length Please specify Month/Year of changes(fm)(fm)(fm)(fm)	
11. Net mesh size (inches) Please specify Month/Year of changes(in)(in)(in)(in)	
12. Did/Do you use knotless mesh?	<input type="checkbox"/> No <input type="checkbox"/> Yes	<input type="checkbox"/> No <input type="checkbox"/> Yes/19..... M/Y	<input type="checkbox"/> No <input type="checkbox"/> Yes/19..... M/Y	<input type="checkbox"/> No <input type="checkbox"/> Yes/19..... M/Y	
13. Ground Gear Type (tick box) Drop chain..... Drop mud rope..... Drop chain with sliding rings..... Danglers or Christmas-tree drops... Looped ground chain..... Drop rope with chain..... Other (please specify)..... Please Specify Month/Year of changes <input type="checkbox"/> <input type="checkbox"/> <input type="checkbox"/> <input type="checkbox"/> <input type="checkbox"/> <input type="checkbox"/> <input type="checkbox"/> <input type="checkbox"/> <input type="checkbox"/> <input type="checkbox"/> <input type="checkbox"/> <input type="checkbox"/> <input type="checkbox"/> <input type="checkbox"/> <input type="checkbox"/> <input type="checkbox"/> <input type="checkbox"/> <input type="checkbox"/> <input type="checkbox"/> <input type="checkbox"/> <input type="checkbox"/> <input type="checkbox"/> <input type="checkbox"/> <input type="checkbox"/>	
14. Ground line specification Maximum gauge of chain (mm) Style of chain link (please circle one style) Do you use Stainless steel chain? Please Specify Month/Year of changes(mm) Short/regular/long <input type="checkbox"/> Yes <input type="checkbox"/> No/19..... M/Y(mm) Short/regular/long <input type="checkbox"/> Yes <input type="checkbox"/> No/19..... M/Y(mm) Short/regular/long <input type="checkbox"/> Yes <input type="checkbox"/> No/19..... M/Y(mm) Short/regular/long <input type="checkbox"/> Yes <input type="checkbox"/> No/19..... M/Y	
15. Otter-boards types (tick box) Bison..... Louvre..... Flat Timber..... Flat Timber-steel Kilfoil..... Collins..... Other (please specify)..... Please specify Month/Year of changes <input type="checkbox"/> <input type="checkbox"/> <input type="checkbox"/> <input type="checkbox"/> <input type="checkbox"/> <input type="checkbox"/> <input type="checkbox"/> <input type="checkbox"/> <input type="checkbox"/> <input type="checkbox"/> <input type="checkbox"/> <input type="checkbox"/> <input type="checkbox"/> <input type="checkbox"/> <input type="checkbox"/> <input type="checkbox"/> <input type="checkbox"/> <input type="checkbox"/> <input type="checkbox"/> <input type="checkbox"/> <input type="checkbox"/> <input type="checkbox"/> <input type="checkbox"/> <input type="checkbox"/>	
16. Otter-board dimensions Length (feet)..... Height (feet)..... Please Specify Month/Year of changes(ft)(ft)(ft)(ft)(ft)(ft)(ft)(ft)	



The Tiger / Endeavour Prawn Fishery

<u>Trawl-Gear</u> Please answer questions row by row.	When you first fished with this vessel	Provide details of any gear changes that have been made during your ownership/operation.		
17. Net Type (Please tick one box) Single..... <input type="checkbox"/> Double..... <input type="checkbox"/> Triple..... <input type="checkbox"/> Quad..... <input type="checkbox"/> Five..... <input type="checkbox"/> Please specify Month/Year of changes				
18. Total Net Head Rope Length Please specify Month/Year of changes(fm)(fm)(fm)(fm)
19. Net mesh size (inches) Please specify Month/Year of changes (in) (in) (in) (in)
20. Did/Do you use knotless mesh?	<input type="checkbox"/> No <input type="checkbox"/> Yes	<input type="checkbox"/> No <input type="checkbox"/> Yes	<input type="checkbox"/> No <input type="checkbox"/> Yes	<input type="checkbox"/> No <input type="checkbox"/> Yes
21. Ground Gear Type (tick box) Drop chain..... <input type="checkbox"/> Drop mud rope..... <input type="checkbox"/> Drop chain with sliding rings..... <input type="checkbox"/> Danglers or Christmas-tree drops... <input type="checkbox"/> Looped ground chain..... <input type="checkbox"/> Drop rope with chain..... <input type="checkbox"/> Other (please specify)..... Please Specify Month/Year of changes				
22. Ground line specification Maximum gauge of chain (mm) Style of chain link (please circle one style) Do you use Stainless steel chain? Please Specify Month/Year of changes(mm) Short/regular/long <input type="checkbox"/> Yes <input type="checkbox"/> No(mm) Short/regular/long <input type="checkbox"/> Yes <input type="checkbox"/> No(mm) Short/regular/long <input type="checkbox"/> Yes <input type="checkbox"/> No(mm) Short/regular/long <input type="checkbox"/> Yes <input type="checkbox"/> No
23. Otter-boards types (tick box) Bison..... <input type="checkbox"/> Louvre..... <input type="checkbox"/> Flat Timber..... <input type="checkbox"/> Flat Timber-steel <input type="checkbox"/> Kilfoil..... <input type="checkbox"/> Collins..... <input type="checkbox"/> Other (please specify)..... Please specify Month/Year of changes				
24. Otter-board dimensions Length (feet)..... Height (feet)..... Please Specify Month/Year of changes(ft)(ft)(ft)(ft)



The Saucer Scallop Fishery

<u>Trawl-Gear</u> Please answer questions row by row.	When you first fished with this vessel	Provide details of any gear changes that have been made during your ownership/operation.		
25. Net Type (Please tick one box) Single..... <input type="checkbox"/> Double..... <input type="checkbox"/> Triple..... <input type="checkbox"/> Quad..... <input type="checkbox"/> Five..... <input type="checkbox"/> Please specify Month/Year of changes	/19..... M/Y/19..... M/Y/19..... M/Y
26. Total Net Head Rope Length(fm) Please specify Month/Year of changes(fm)/19..... M/Y/19..... M/Y/19..... M/Y
27. Net mesh size (inches) (in) Please specify Month/Year of changes (in)/19..... M/Y/19..... M/Y/19..... M/Y
28. Did/Do you use knotless mesh?	<input type="checkbox"/> No <input type="checkbox"/> Yes	<input type="checkbox"/> No <input type="checkbox"/> Yes/19..... M/Y	<input type="checkbox"/> No <input type="checkbox"/> Yes/19..... M/Y	<input type="checkbox"/> No <input type="checkbox"/> Yes/19..... M/Y
29. Ground Gear Type (tick box) Drop chain..... <input type="checkbox"/> Drop mud rope..... <input type="checkbox"/> Drop chain with sliding rings..... <input type="checkbox"/> Danglers or Christmas-tree drops... <input type="checkbox"/> Looped ground chain..... <input type="checkbox"/> Drop rope with chain..... <input type="checkbox"/> Other (please specify)..... Please Specify Month/Year of changes	/19..... M/Y/19..... M/Y/19..... M/Y
30. Ground line specification Maximum gauge of chain (mm) Style of chain link (please circle one style) Do you use Stainless steel chain? Please Specify Month/Year of changes(mm) Short/regular/long <input type="checkbox"/> Yes <input type="checkbox"/> No(mm) Short/regular/long <input type="checkbox"/> Yes <input type="checkbox"/> No/19..... M/Y(mm) Short/regular/long <input type="checkbox"/> Yes <input type="checkbox"/> No/19..... M/Y(mm) Short/regular/long <input type="checkbox"/> Yes <input type="checkbox"/> No/19..... M/Y
31. Otter-boards types (tick box) Bison..... <input type="checkbox"/> Louvre..... <input type="checkbox"/> Flat Timber..... <input type="checkbox"/> Flat Timber-steel <input type="checkbox"/> Kilfoil..... <input type="checkbox"/> Collins..... <input type="checkbox"/> Other (please specify)..... Please specify Month/Year of changes	/19..... M/Y/19..... M/Y/19..... M/Y
32. Otter-board dimensions Length (feet)..... Height (feet)..... Please Specify Month/Year of changes(ft)(ft)(ft)(ft)/19..... M/Y(ft)(ft)/19..... M/Y(ft)(ft)/19..... M/Y

Additional Comments

1. Do you have any comments on factors that you believe effects your vessel fishing performance?

.....

.....

.....

.....

.....

2. Do you have any comments on bycatch reduction devices (BRD) or turtle exclusion devices (TED) use in the eastern king prawn, tiger prawn or scallop fisheries?

.....

.....

.....

.....

.....

3. How do you think the Queensland Department of Primary Industries could improve the extension of research results to the fishing industry?

.....

.....

.....

.....

.....

4. Do you have any other comments?

.....

.....

.....

.....

.....

.....

.....

.....

.....

.....

.....

Otter Board Types

(Drawings courtesy of D. J. Sterling Trawl Gear Services)

Bison

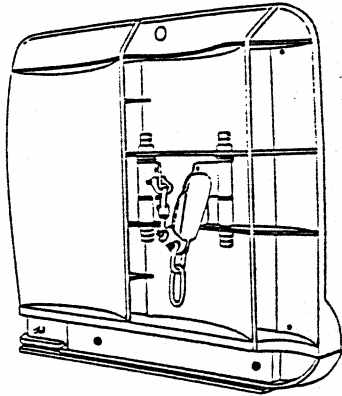

Perfect

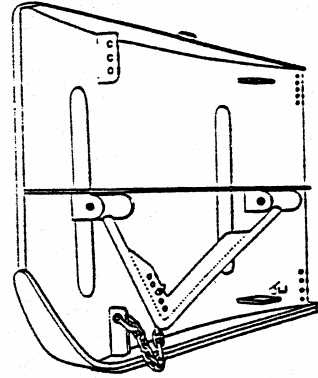

Flat (timber or timber-steel)

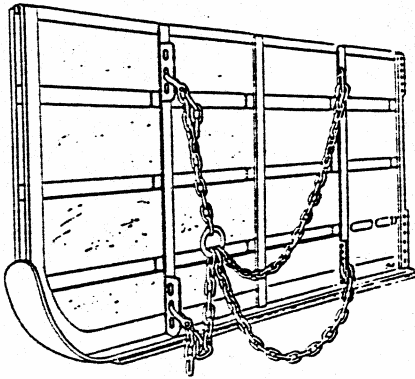

Superflow

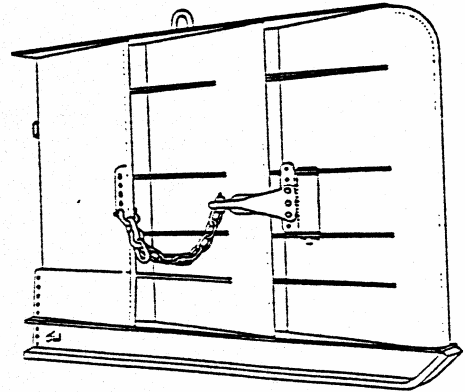

Kilfoil

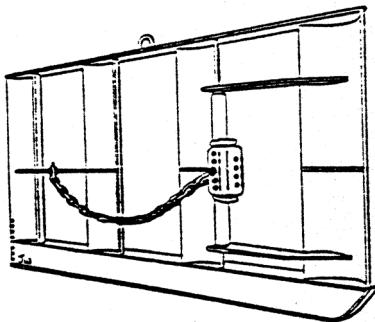

Saje cambered

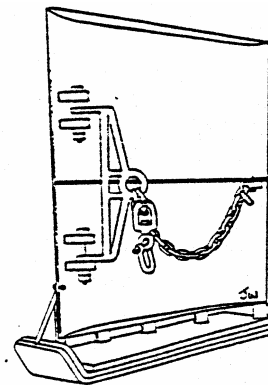

Types of Ground Gear

(Drawings from Davies, P, 1992. Professional Fisherman's Guide to Making Prawn Trawl Nets.)

Drop chain

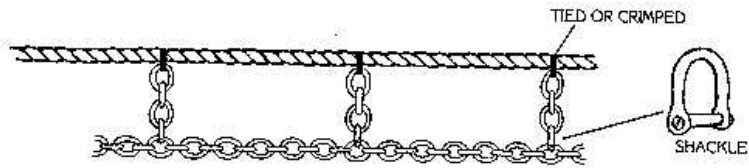

Drop mud rope

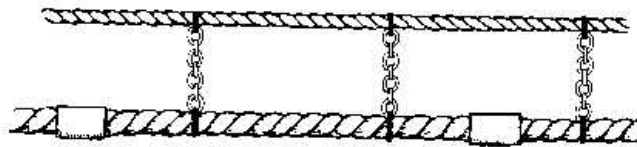

Drop chain with sliding rings

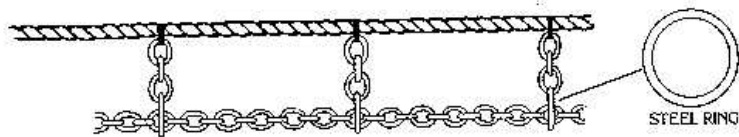

Danglers or Christmas tree drops

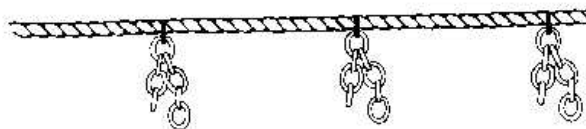

Looped ground chain

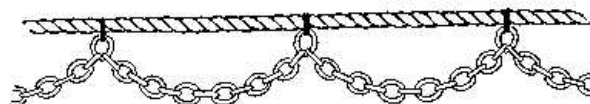

Bycatch Reduction Devices

(Drawings courtesy of J. McGilvray and J. Robins, Southern Fisheries Centre.)

Square mesh windows

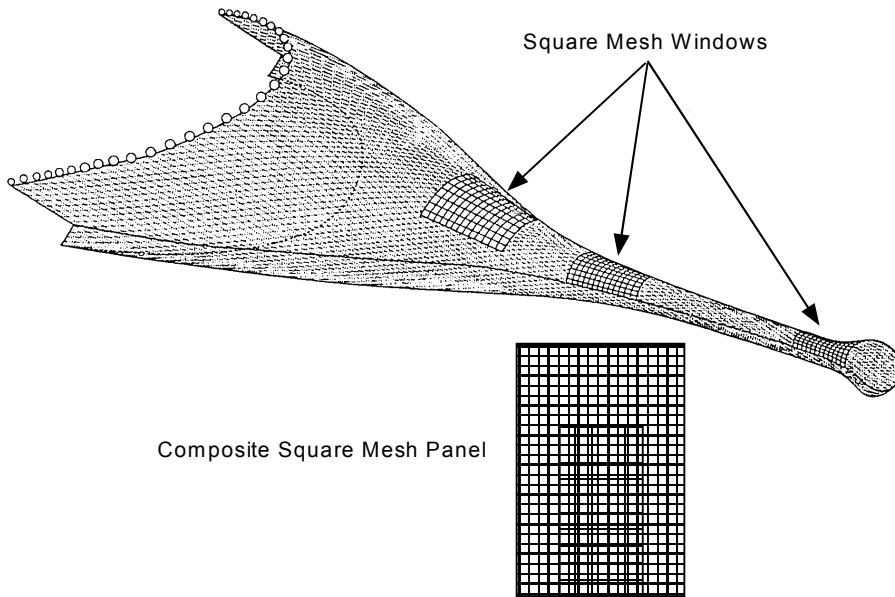

Square mesh codend

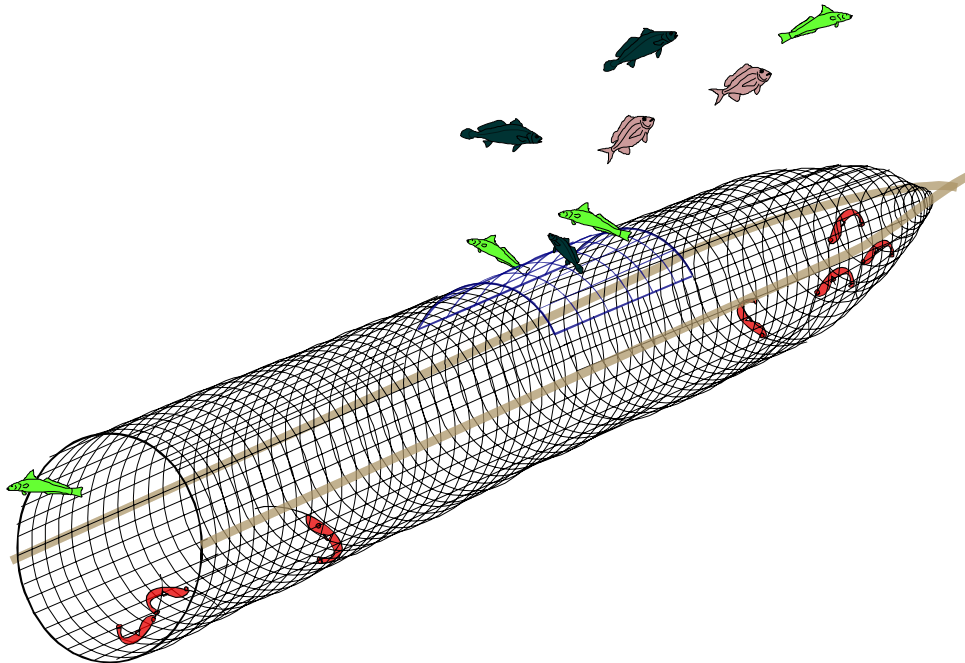

Bycatch Reduction Devices (cont.)

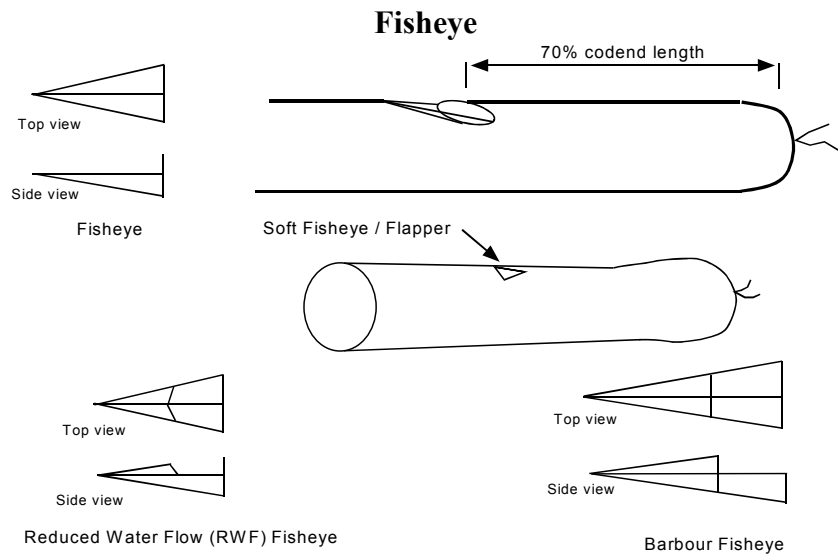

Bigeye

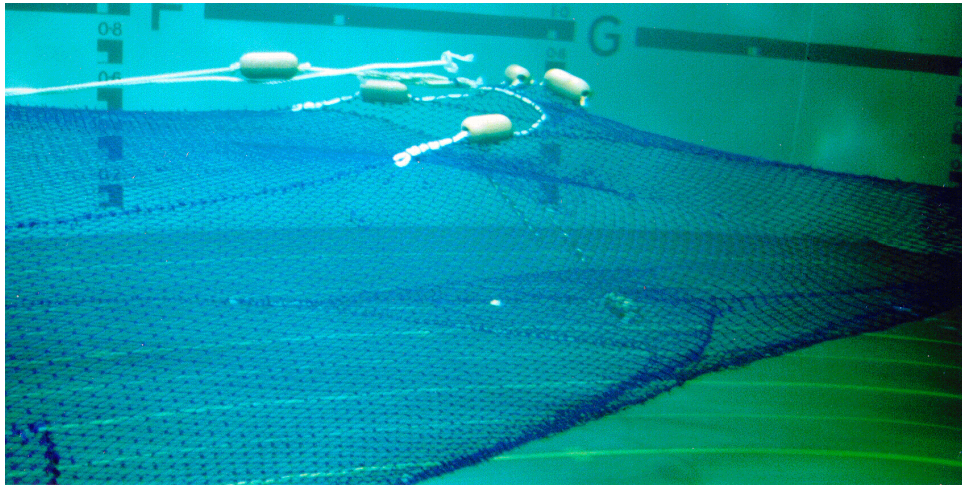

Radial escape

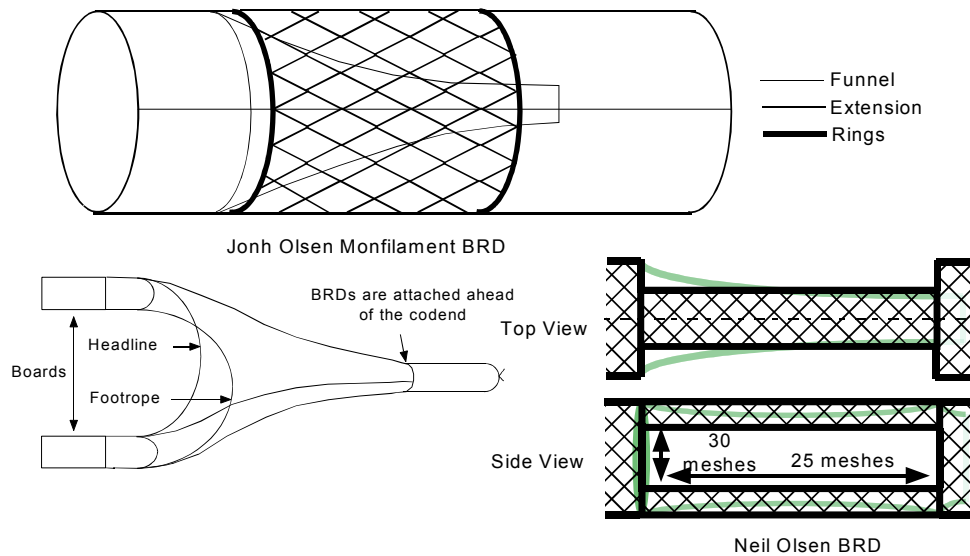

Turtle Exclusion Devices

Super shooter

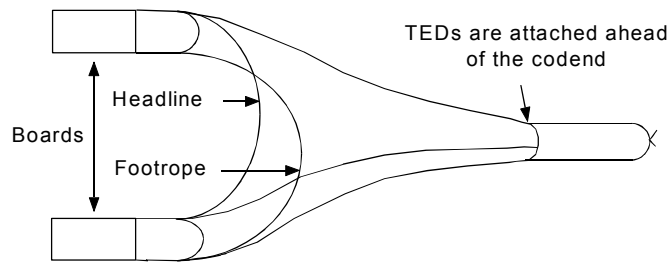
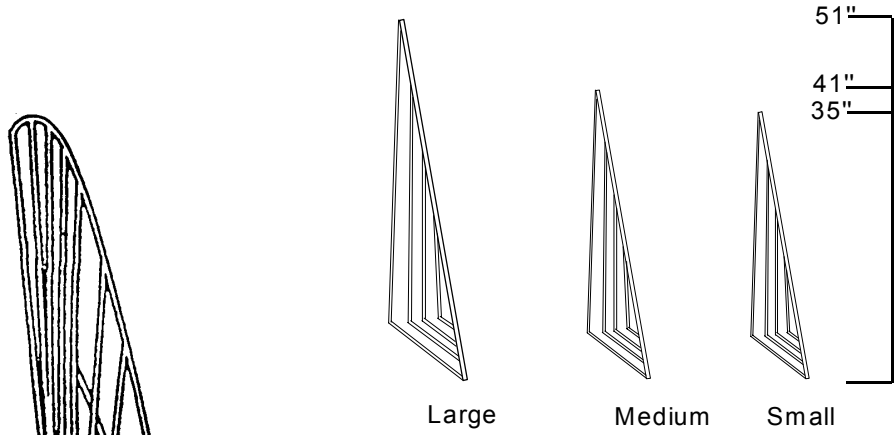

AusTED

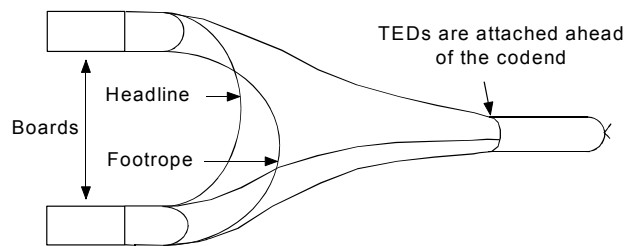
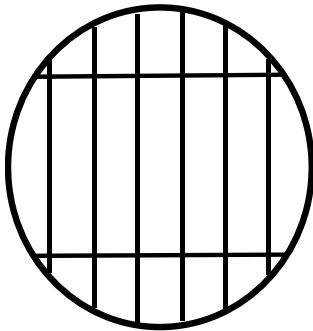
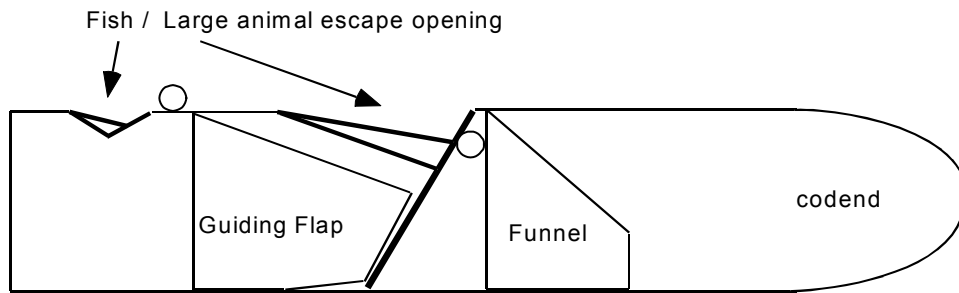

Turtle Exclusion Devices (cont.)

Nordmore

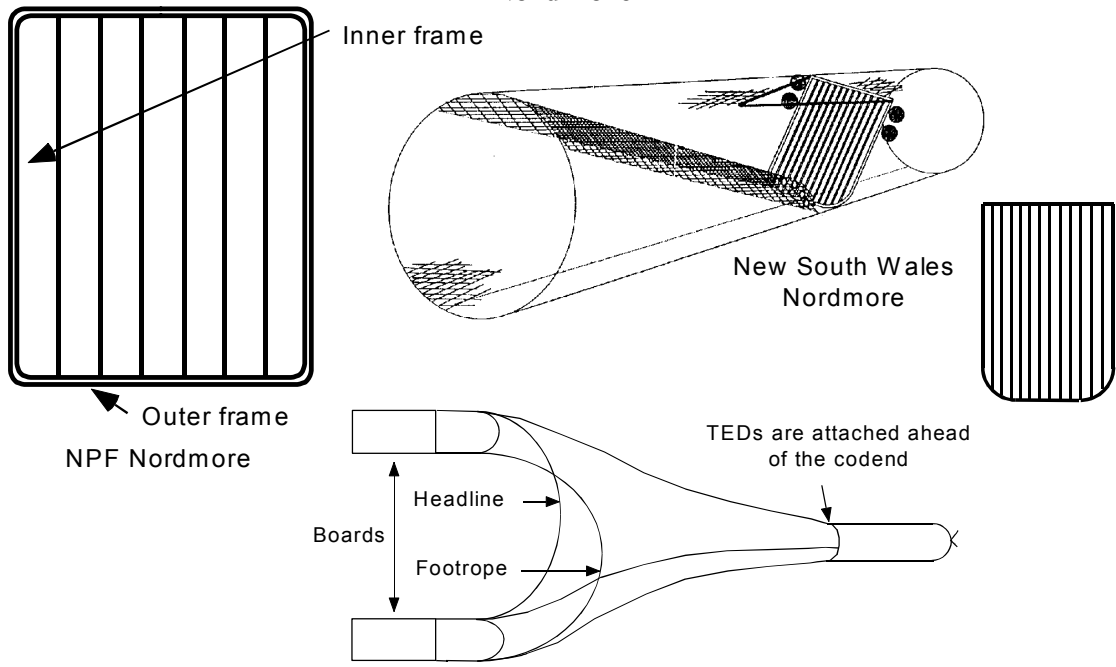

Seymour



Turtle Exclusion Devices (cont.)

Kevin Wicks

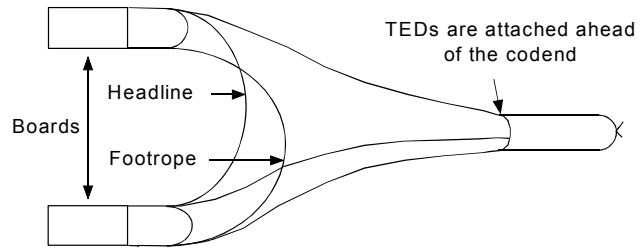
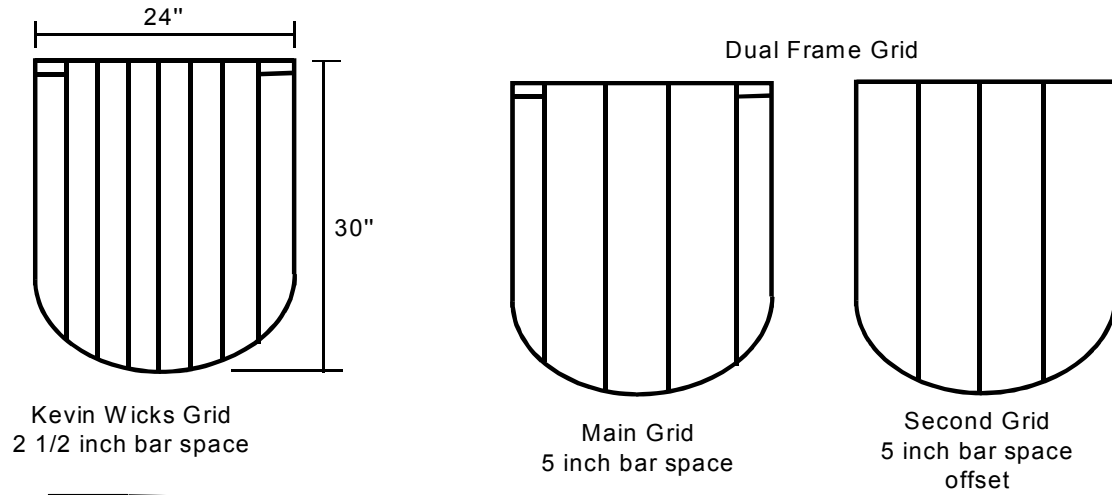

Standard Grid

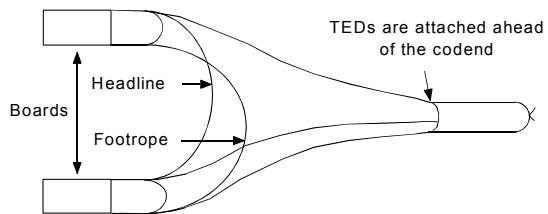
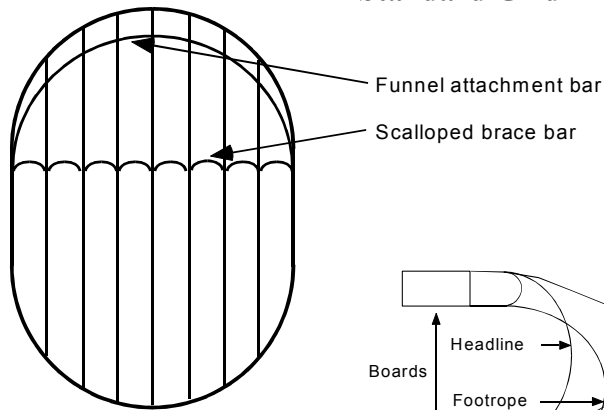

Turtle Exclusion Devices (cont.)

Weedless

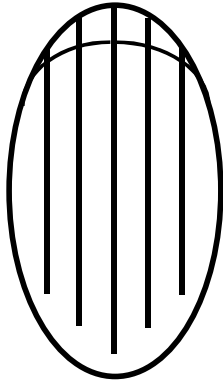

Large

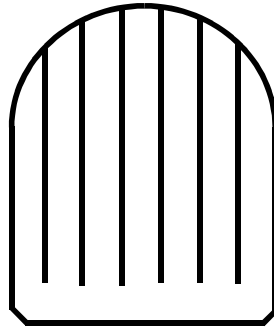

Small

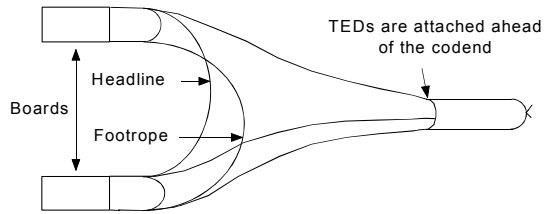

Flounder

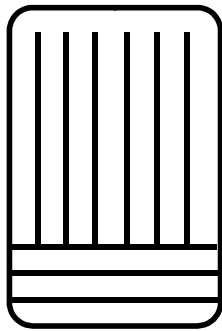

Weedless Flounder TED

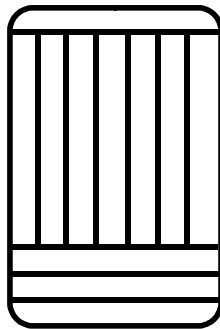

Flounder TED

